

*SEMICUSTOM***Built-in IF Band Voltage Controlled Oscillator
Mask ROM Frequency Synthesizer****MB15C700 series****■ DESCRIPTION**

MB15C700 series is a Phase Locked Loop (PLL) frequency synthesizer of pulse swallow operation with built-in VCO suitable for Intermediate Frequency band synthesizer of mobile phones.

The VCO can operate option oscillation frequency by an external inductance and capacitor. The PLL reference divider ratio and comparison divider ratio are fixed, so that it is not required to set the divider ratios by a microcontroller externally. BCC-20 plastic package is miniaturized the device and makes it easier to design.

It operates with a supply voltage of 2.5 V typ. (PLL_{VDD}, VCO_{VDD}) and low power consumption current 4.5 mA typ. (PLL + VCO at 400 MHz) is realized by pure- CMOS technology.

■ FEATURES

<<PLL>>

- Pulse swallow function
- 400 MHz High-speed Prescaler : 8/9, 16/17, 32/33
- MASK ROM optimal the comparison and reference dividers :
Comparison counter : Main counter : 5 to 4095, Swallow counter : 0 to 31
Reference counter : 5 to 4095 (up to 26 MHz)
- Lock detector circuit: Digital lock detector circuit which is "H" level when PLL is locked.

(Continued)

■ PACKAGE

20-pad, plastic BCC

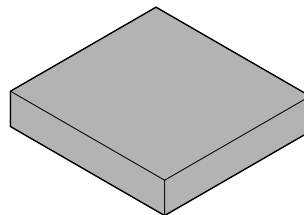

LCC-20P-M04

■ PIN DESCRIPTIONS

Pin No.	Symbol	I/O	Descriptions
1	VCOGND	—	Ground for the VCO.
2	N.C.	—	No connection.
3	VCOCNT	I	VCO control voltage input. Connection to PLLDo terminal via LPF.
4	VCOPS	I	Power saving control for the VCO. (Open is prohibited.) “H” : Normal mode “L” : Power saving mode
5	VCOVDD	—	Power supply voltage input for VCO. Connect to capacitor between GND.
6	LD	O	Lock detector signal output. LD = “H” : Locking mode or power saving mode LD = “L” : Unlocking mode.
7	N.C.	—	No connection.
8	OSCI _n	I	The reference counter input. Connect with a AC coupling capacitor.
9	f _{out}	O	Test purpose output. This pin is an open drain output.
10	PLLVDD	—	Power supply voltage input for the PLL. Connect to capacitor between GND
11	N.C.	—	No connection
12	N.C.	—	No connection.
13	PLLDo	O	PLL charge pump output. Connect to VCOCNT pin via LPF.
14	PLLGND	—	Ground for the PLL.
15	PLLfin	I	Prescaler input. Connect with an AC coupling capacitor.
16	PLLPS	I	Power saving control for the PLL. (Open is prohibited.) “H” : Normal mode “L” : Power saving mode
17	N.C.	—	No connection.
18	VCO _{out}	O	VCO output.
19	VCOTNKI	I	VCOTANK circuit input. Connect to VCOTNKO pin with inductance and resistance. Connect to capacitor between GND.
20	VCOTNKO	O	VCOTANK circuit output. Connect to VCOTNKI terminal with inductance and resistance. Connect to capacitor between GND. (max.2.0 pF)

MB15C700 series

■ BLOCK DIAGRAM

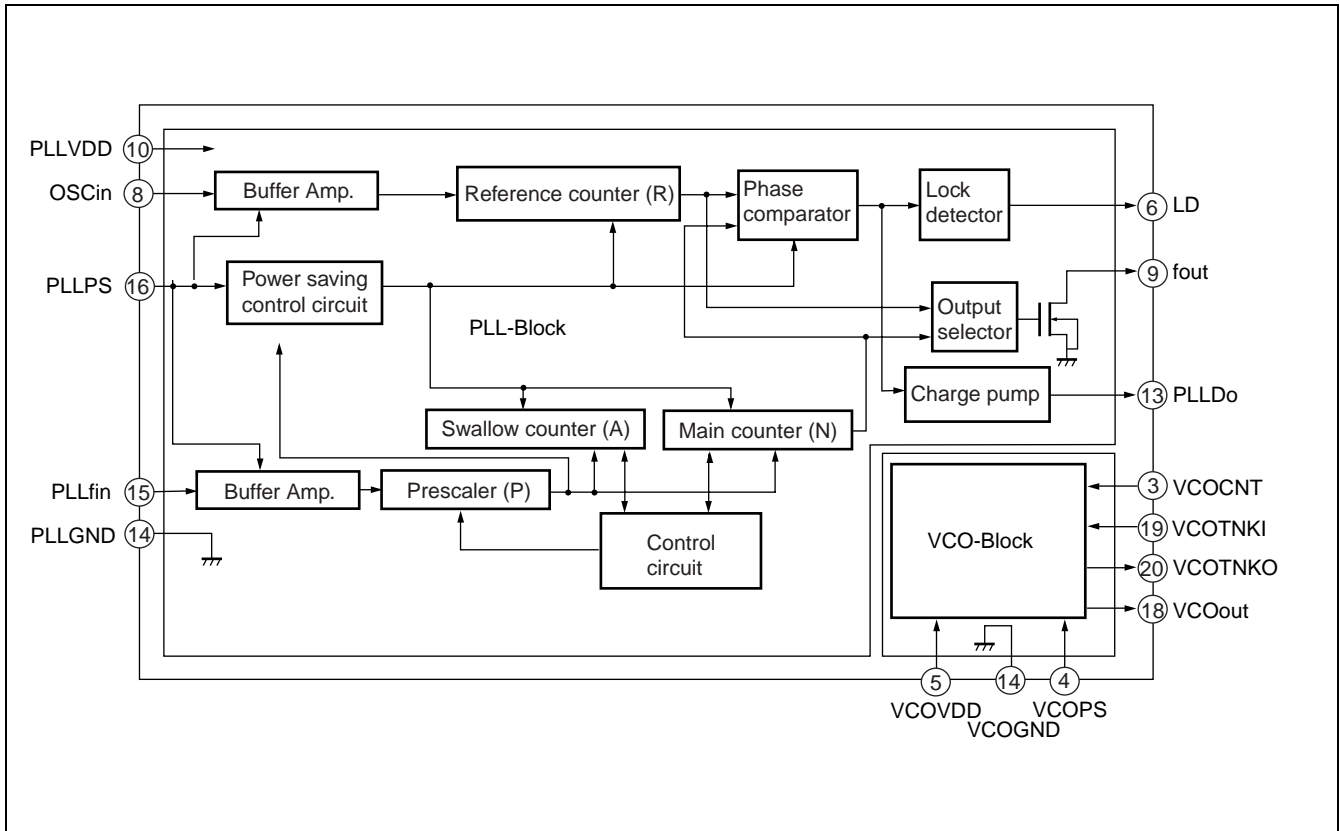

■ FUNCTIONAL DESCRIPTIONS

Divide ratios of the internal counters can be set optionally according to customer requirements.

The divide ratio can be calculated using the following equation.

$$f_{vco} = [(P \times N + A)] \times f_{osc} / R$$

Note: $N > A$, $P > A$

- f_{vco} : Output frequency of Voltage Controlled Oscillator (VCOout up to 400 MHz)
- f_{osc} : Reference oscillation frequency (up to 26 MHz)
- N : Divide ratio of the main counter (5 to 4095)
- A : Divide ratio of the swallow counter (0 to 31)
- P : Preset divide ratio of dual modulus prescaler (8/9, 16/17, 32/33)
- R : Divide ratio of the reference counter (5 to 4095)

■ ABSOLUTE MAXIMUM RATINGS

Parameter	Symbol		Rating		Unit
			Min.	Max.	
Power supply voltage	V _{DD}	PLLVD	-0.5	4.0	V
		VCOVDD			
Output voltage	V _O		-0.5	V _{DD} +0.5	V
Input voltage	V _I		-0.5	V _{DD} +0.5	V
Output current	I _O		0	+5.0	mA
Storage temperature	T _{stg}		-55	+125	°C

WARNING: Semiconductor devices can be permanently damaged by application of stress (voltage, current, temperature, etc.) in excess of absolute maximum ratings. Do not exceed these ratings.

■ RECOMMENDED OPERATING CONDITIONS

Parameter	Symbol		Value			Unit
			Min.	Typ.	Max.	
Power supply voltage	V _{DD}	PLLVD	2.3	2.5	2.7	V
		VCOVDD				
Input voltage	V _{IN}		GND	—	V _{DD}	V
Operating temperature	T _a		-20	—	+85	°C

WARNING: The recommended operating conditions are required in order to ensure the normal operation of the semiconductor device. All of the device's electrical characteristics are warranted when the device is operated within these ranges.

Always use semiconductor devices within their recommended operating condition ranges. Operation outside these ranges may adversely affect reliability and could result in device failure.

No warranty is made with respect to uses, operating conditions, or combinations not represented on the data sheet. Users considering application outside the listed conditions are advised to contact their FUJITSU representatives beforehand.

MB15C700 series

■ ELECTRICAL CHARACTERISTICS

(Recommended operating conditions unless otherwise noted.)

Parameter	Symbol	Condition	Value			Unit	
			Min.	Typ.*	Max.		
Power supply current	PLLVD	I_{PLL}	PLLVD = VCOVD = 2.5 V PLL-Lock (400 MHz)	—	4.5	—	mA
	VCOVD	I_{VCO}					
Power saving current	PLLVD	I_{PLLPS}	PLLPS = "L"	—	1.0	10.0	μ A
	VCOVD	I_{VCOPS}	VCOPS = "L"	—	—	1.0	μ A
Operating frequency	PLLfin	f_{in}	AC coupling by 1000 pF capacitor	100	—	400	MHz
	OSCin	f_{osc}	AC coupling by 1000 pF capacitor	3	—	26	MHz
Input sensitivity	OSCin	V_{osc}	AC coupling by 1000 pF capacitor	0.5	—	—	Vp-p
Input current	OSCin	I_{osc}	—	-100	—	100	μ A
Output voltage Charge pump type : H Charge pump type : L	PLLDo	V_{OH}	$I_{OH} = -0.3$ mA	PLLVD -0.8	—	—	V
		V_{OL}	$I_{OL} = 0.3$ mA	—	—	0.4	
Output current Type : H	PLLDo	I_{OH}	PLLVD = 2.5 V $V_{OH} = 1.5$ V	—	-4.5	—	mA
		I_{OL}	PLLVD = 2.5 V $V_{OL} = 1.0$ V	—	4.5	—	
Output current Type : L	PLLDo	I_{OH}	PLLVD = 2.5 V $V_{OH} = 1.5$ V	—	-1.125	—	mA
		I_{OL}	PLLVD = 2.5 V $V_{OL} = 1.0$ V	—	1.125	—	
High impedance cutoff current	PLLDo	I_{OFF}	$0\text{ V} \leq \text{PLLVD}_o \leq \text{PLLVD}$	—	—	3.0	nA

*: PLLVD = VCOVD = 2.5 V, $T_a = +25$ °C

■ REFERENCE CHARACTERISTICS

(PLLVD = VCOVDD = 2.5 V, Ta = +25 °C)

Parameter	Symbol	Condition	Value			Unit
			Min.	Typ.	Max.	
VCO variable range	Δf	f_{vco1} (at VCOCNT = 0.8 V) – f_{vco2} (at VCOCNT = 1.8 V)	4.0	—	—	MHz
VCO output level	V_{VCOout}	—	—	-12	—	dBm
SYN reference leakage	Lef1	$\Delta \pm fr$	—	-67	—	dBc
	Lef2	$\Delta \pm (fr \times 2)$	—	-70	—	
SYN output S/N	S/N	$\Delta 1$ kHz	—	—	—	dBc
SYN output C/N	C/N1	$\Delta \pm 50$ kHz	—	-68	—	dBc
	C/N2	$\Delta \pm 100$ kHz	—	-74	—	
Spurious	Lsp1	2nd Harmonic (Δf_{vco})	—	-3	—	dBc
	Lsp2	3rd Harmonic ($\Delta (f_{vco} \times 2)$)	—	-10	—	
	Lsp3	4th Harmonic ($\Delta (f_{vco} \times 3)$)	—	-18	—	
	Lsp4	Other ($\Delta (f_{vco} \times 4)$)	—	-30	—	
	Lsp5	TRX band ($\Delta (f_{vco} \times 5)$)	—	-35	—	
	Lsp6	TRX band ($\Delta (f_{vco} \times 6)$)	—	-40	—	
	Lsp7	$\Delta (f_{vco} \times 7)$	—	-50	—	
	Lsp8	$\Delta (f_{vco} \times 8)$	—	-55	—	
	Lsp9	$\Delta (f_{vco} \times 9)$	—	-55	—	
	Lsp10	$\Delta (f_{vco} \times 10)$	—	-60	—	
Lock-up time	T_{LOCK}	PLLPS “L” to “H” f_{vco} within ± 300 Hz, $V_{VCOout} = -12 \pm 3$ dBm	—	—	4.0	ms
VCO operating control voltage range	ΔV_{CNT}	—	0.5	—	VCOVDD - 0.2	V

*1 : An external components (inductance and capacitor) connected with VCOTANK are recommended to use an component with nominal value within 2%.

*2 : An capacitor connected between VCOTNKO and GND is less than 2.0 pF.

*3 : The condition of above reference data is $fr \geq 50$ kHz.

MB15C700 series

■ PHASE COMPARATOR OUTPUT WAVE FORM

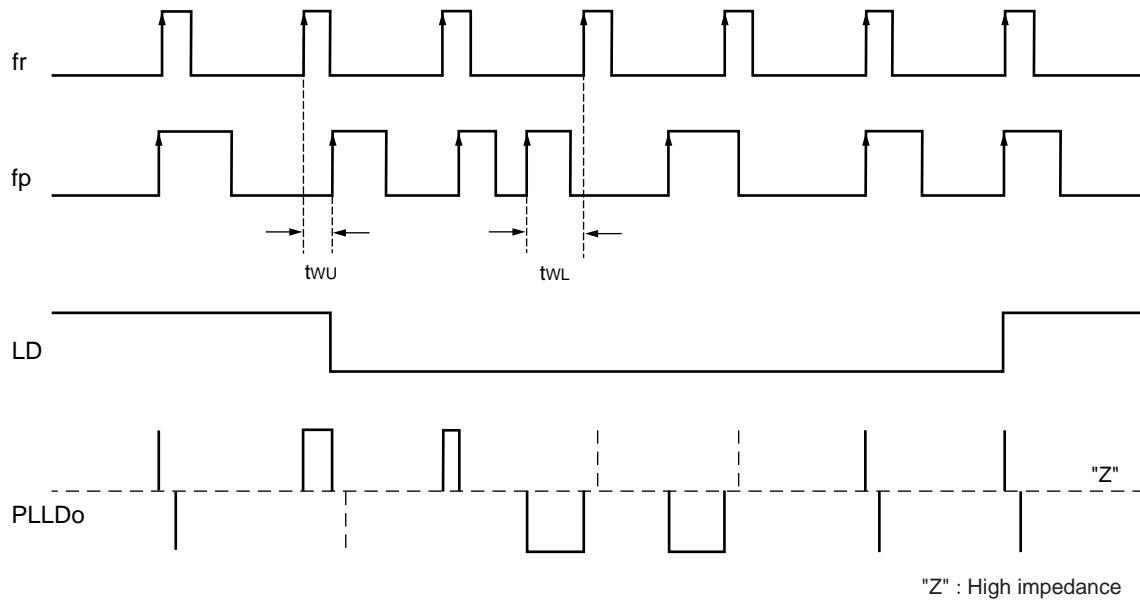

- Notes :
- Phase error detection range : -2π to $+2\pi$
 - Spikes on Do pulse during locking state are output to prevent dead zone
 - LD output becomes "L" level when phase error is t_{WU} or more.
 - LD output becomes "H" level when phase error is t_{WL} or less and continues to be so for three cycles or more.
 - t_{WU} and t_{WL} depend on OSCin input frequency.
 - $t_{WU} \geq 8/f_{osc}$ [s] : i.e. $t_{WU} \geq 625$ ns, $f_{osc} = 12.8$ MHz
 - $t_{WL} \leq 16/f_{osc}$ [s] : i.e. $t_{WL} \leq 1250$ ns, $f_{osc} = 12.8$ MHz

■ TYPICAL CHARACTERISTICS

1. fin input sensitivity

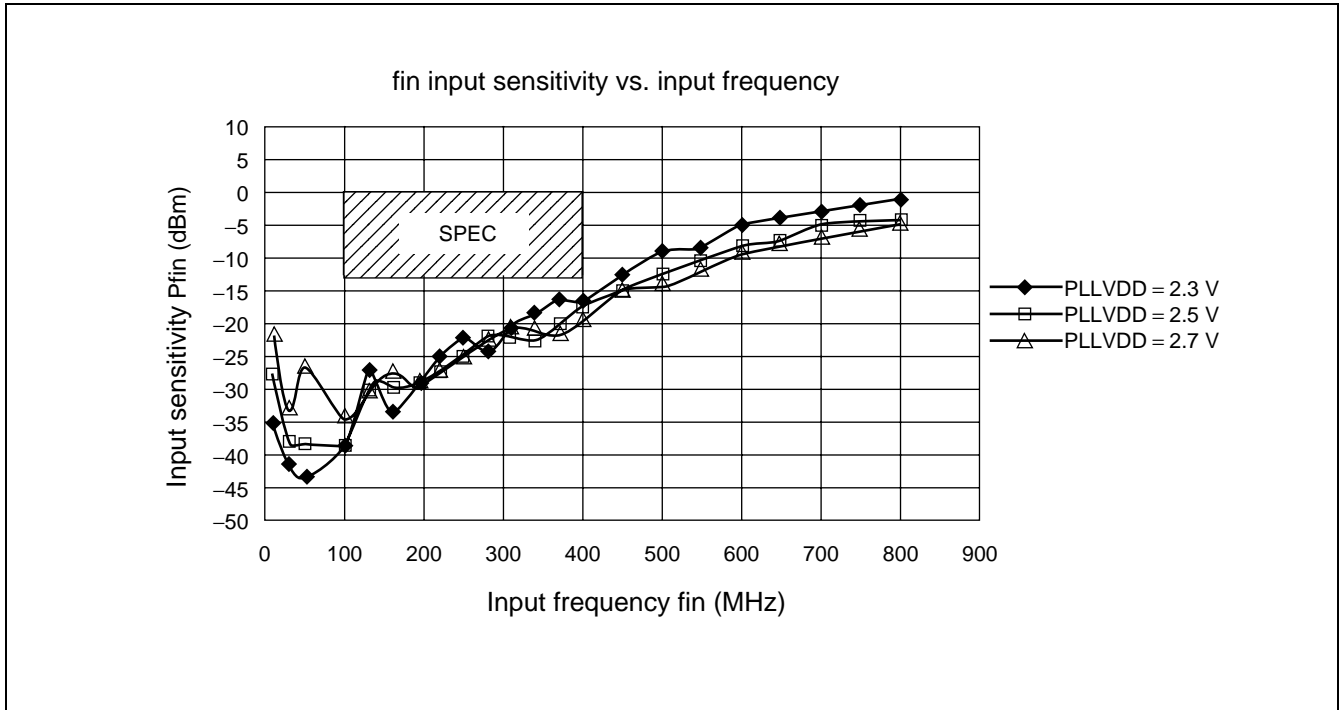

2. OSCin input sensitivity

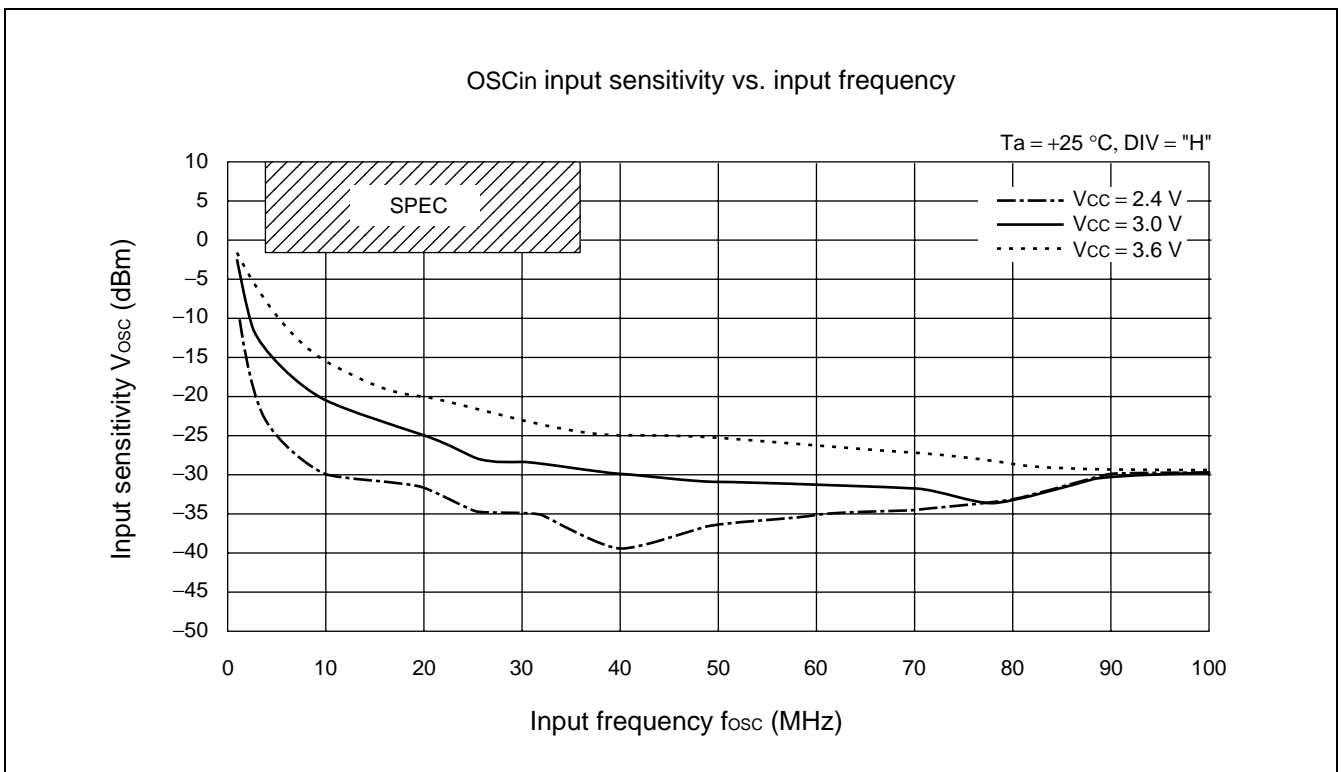

MB15C700 series

3. Do output current

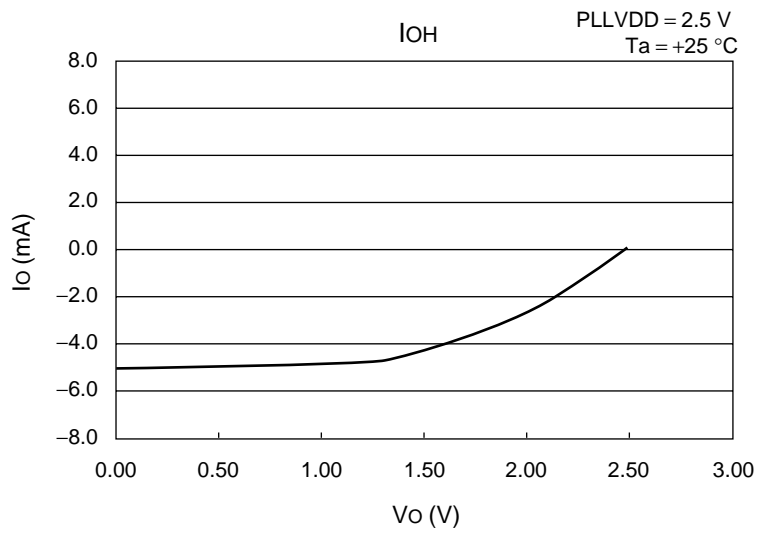
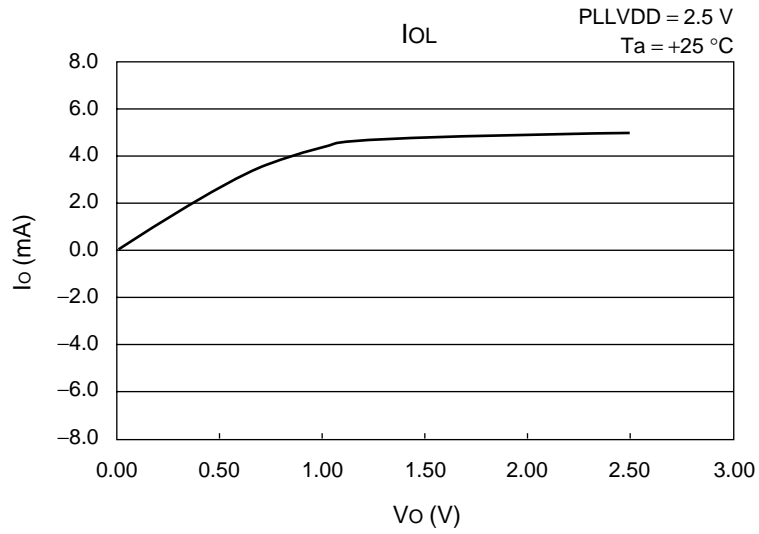

REFERENCE CHARACTERISTICS DATA

PLLVD = VCOVDD = 2.5 V, Ta = +25 °C

f_{vco} = 129.55 MHz, OSCin = 12.8 MHz, fr = 50 kHz

[Measurement circuit]

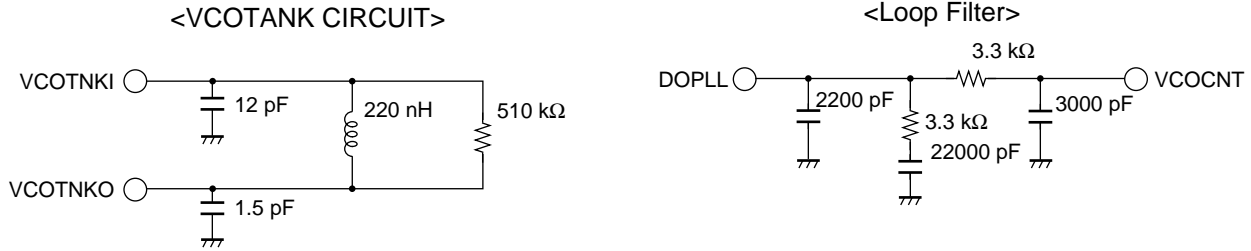

1. Measurement result

Parameter		Condition	Result	
VCO variable range	Δf	f _{vco1} (@VCOCNT = 0.8 V) – f _{vco2} (@VCOCNT = 1.8 V)	8.657	MHz
Reference leakage	Lref1 (+)	$\Delta +fr$	-67.3	dBc
	Lref1 (-)	$\Delta -fr$	-66.7	
	Lref2 (+)	$\Delta + (fr \times 2)$	-72	
	Lref2 (-)	$\Delta - (fr \times 2)$	-72	
S/N	S/N	$\Delta 1$ kHz	-71.3	dBc
C/N (BW = 21kHz)	C/N1 (+)	$\Delta +50$ kHz	-108	dBc/Hz
	C/N1 (-)	$\Delta -50$ kHz	-108	
	C/N2 (+)	$\Delta +100$ kHz	-113	
	C/N2 (-)	$\Delta -100$ kHz	-113	
Spurious	Lsp1	2nd Harmonic (Δf_{vco})	-4.2	dBc
	Lsp2	3rd Harmonic ($\Delta (f_{vco} \times 2)$)	-10.8	
	Lsp3	4th Harmonic ($\Delta (f_{vco} \times 3)$)	-23.3	
	Lsp4	Other ($\Delta (f_{vco} \times 4)$)	-26.0	
	Lsp5	TRX band ($\Delta (f_{vco} \times 5)$)	-29.2	
	Lsp6	TRX band ($\Delta (f_{vco} \times 6)$)	-35.7	
	Lsp7	$\Delta (f_{vco} \times 7)$	-44.3	
	Lsp8	$\Delta (f_{vco} \times 8)$	-49.2	
	Lsp9	$\Delta (f_{vco} \times 9)$	-51.7	
	Lsp10	$\Delta (f_{vco} \times 10)$	-60.7	
Lock-up time	T _{LOCK}	PLLPS "L" to "H" f _{vco} within ± 300 Hz, V _{VCOout} = -12 ± 3 dBm	0.622	ms

MB15C700 series

2. Characteristics wave form

- V_{VCOCNT} – f_{VCOout} Characteristics

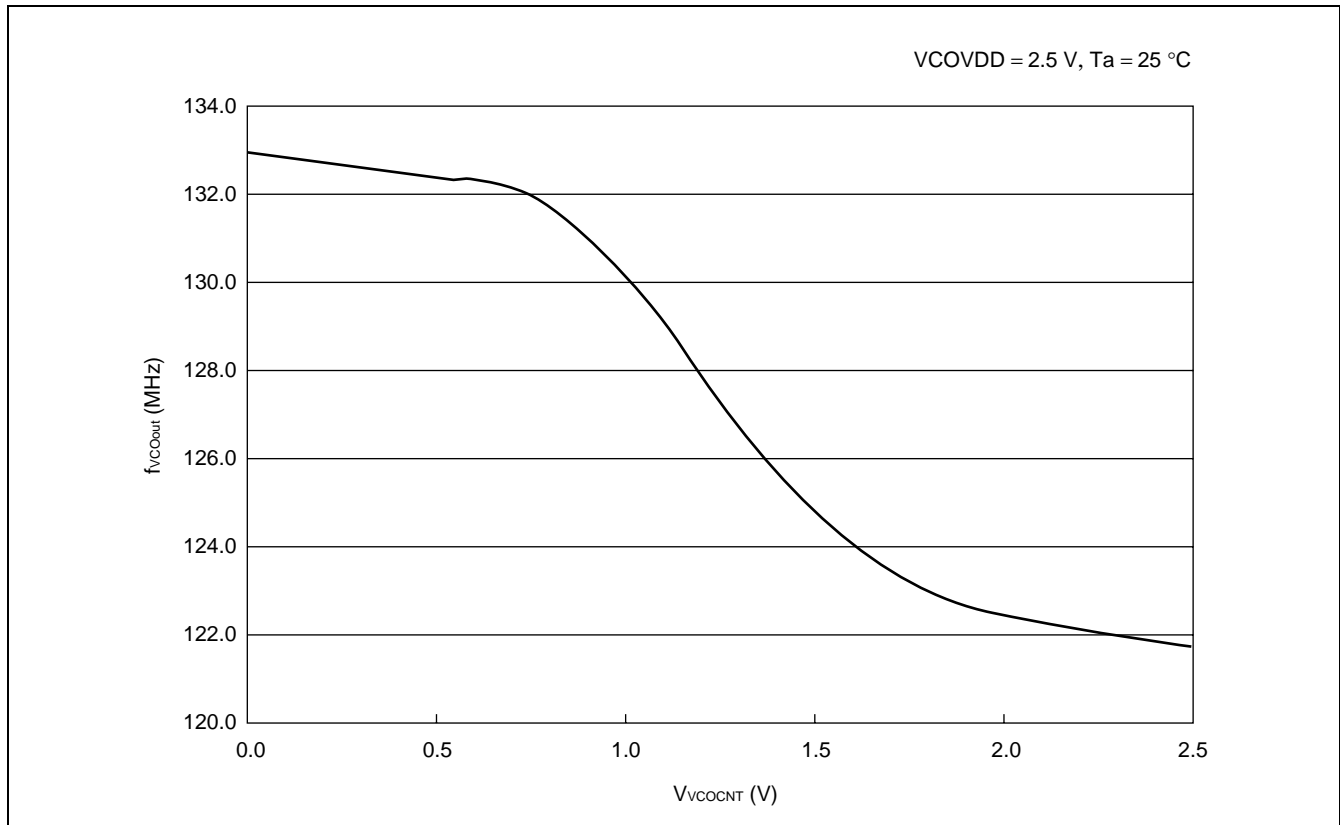

- Spectrum Wave Form (Reference Leakage)

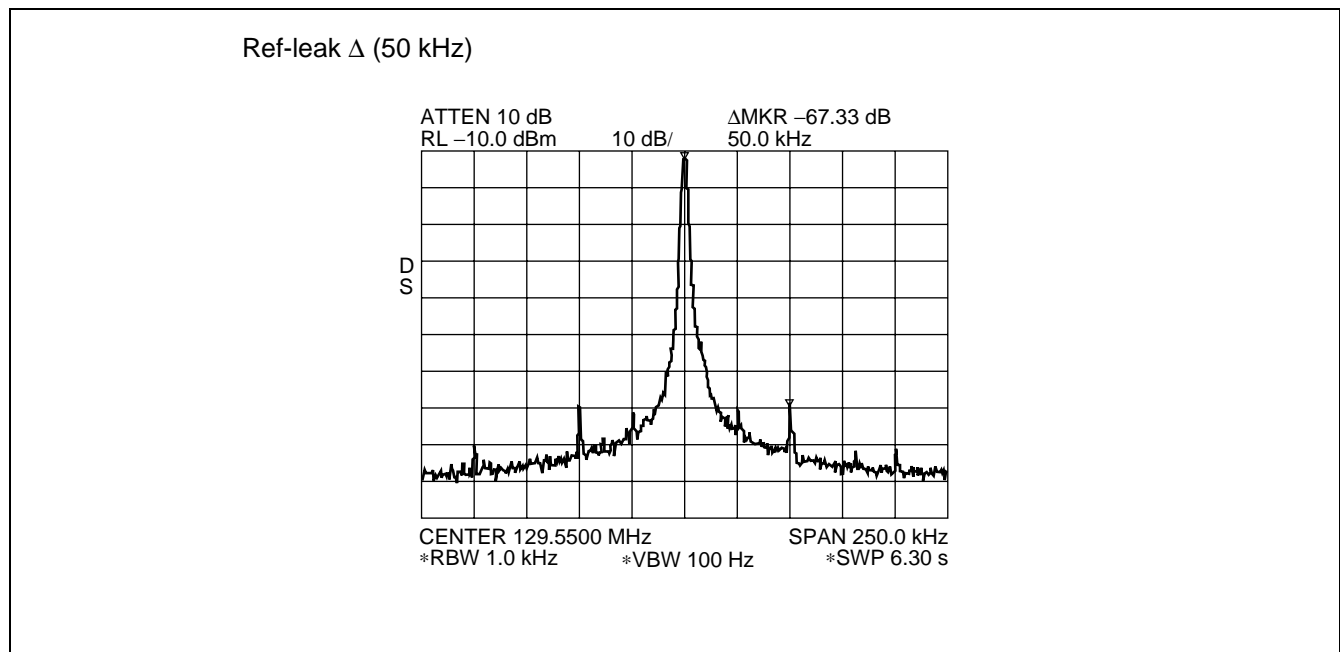

MB15C700 series

- Spectrum Wave Form (C/N, S/N, Spurious, Lock-up Time)

C/N Δ (50 kHz)

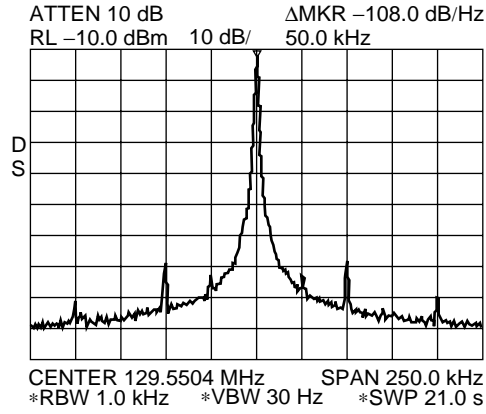

S/N Δ (1 kHz)

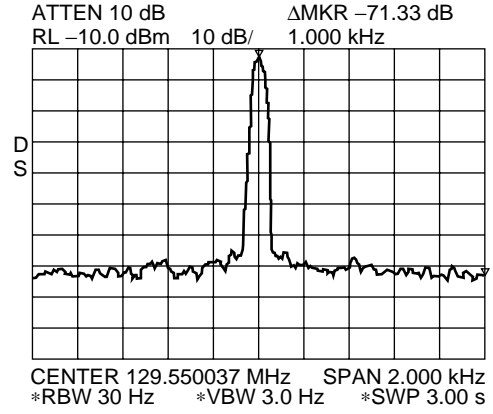

Spurious

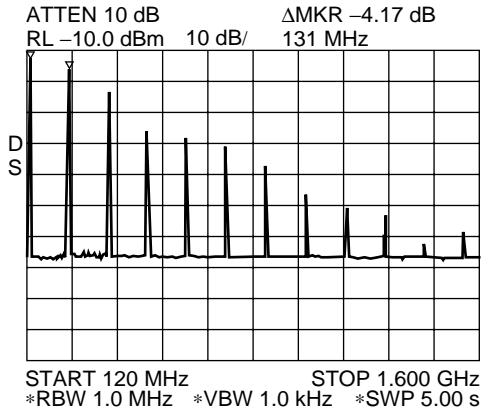

Lock up time (PSmode to Lock, f_{vco} within ± 300 Hz)

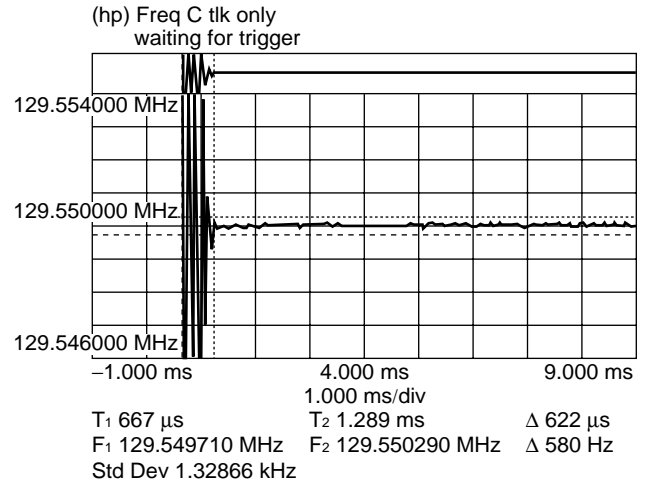

MB15C700 series

APPLICATION EXAMPLE

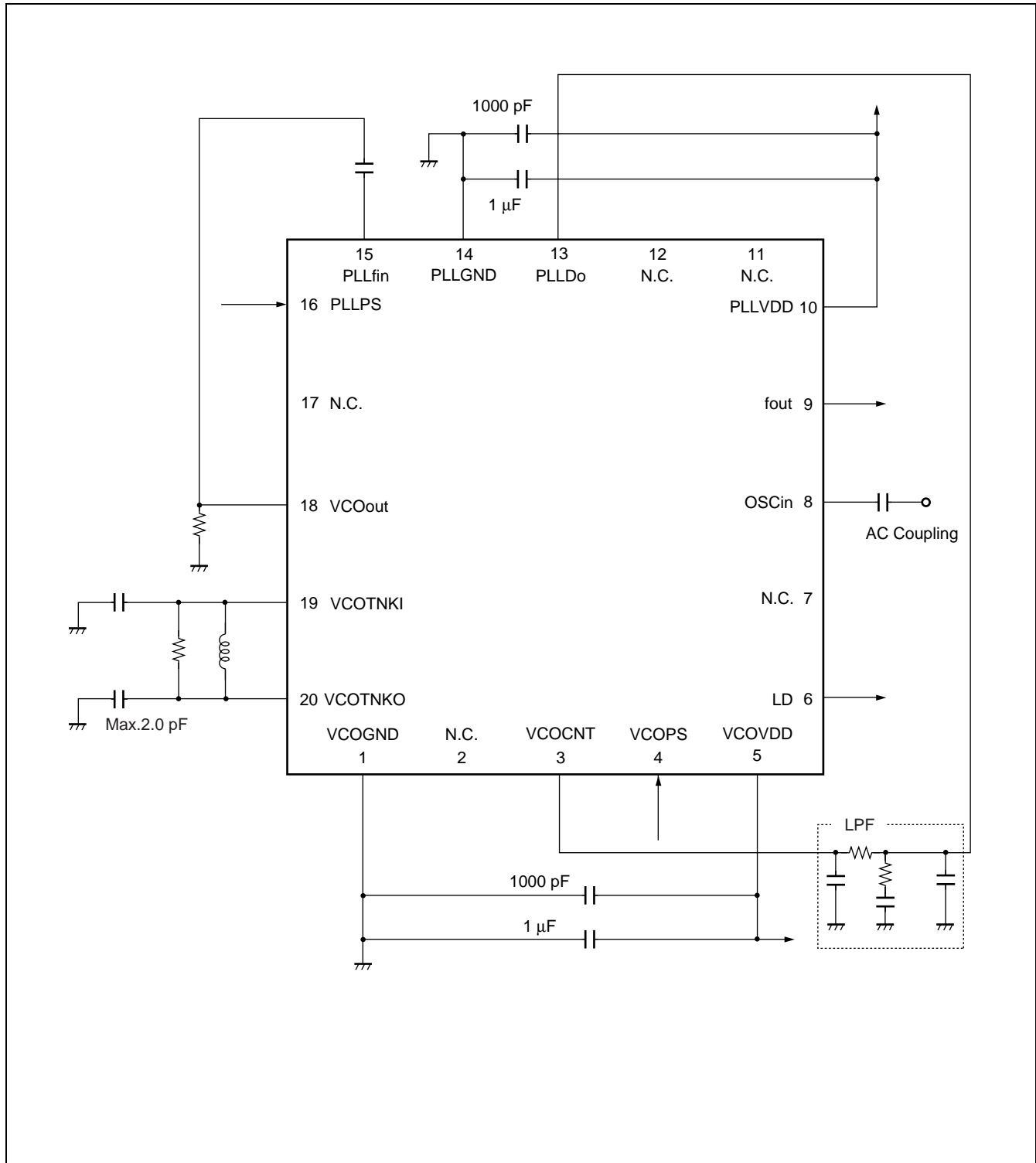

■ USAGE PRECAUTIONS

To protect against damage by electrostatic discharge, note the following handling precautions:

- Store and transport devices in conductive containers.
- Use properly grounded workstations, tools, and equipment.
- Turn off power before inserting device into or removing device from a socket.
- Protect leads with a conductive sheet when transporting a board-mounted device.

■ ORDERING INFORMATION

Part number	Package	Remarks
MB15C700PV	20-pad, Plastic BCC (LCC-20P-M04)	

MB15C700 series

PACKAGE DIMENSION

20-pad, plastic BCC
(LCC-20P-M04)

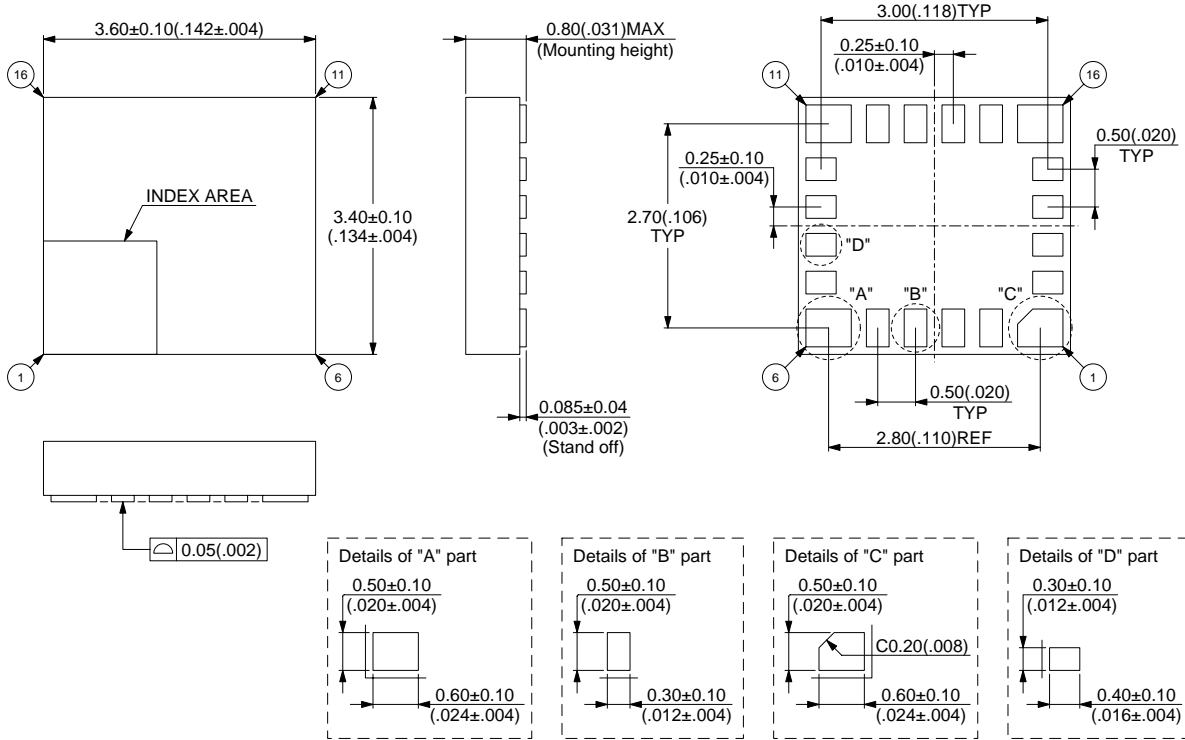

© 1999 FUJITSU LIMITED C20055S-1C-1

Dimensions in mm (inches)

■ CUSTOMER REQUESTING SPECIFICATIONS

Parameter		Option	Requirements
f_{VCO}	VCO output frequency	100 to 400 MHz $f_{VCO} = [(P \times N) + A] \times f_r$ ($N > A, P > A$)	
f_{ORC}	Reference oscillation frequency	3 to 26 MHz $f_{osc} = R \times f_r$	
Comparison divider	N	Main counter divide ratio	5 to 4095
	A	Swallow counter divide ratio	0 to 31
	P	Prescaler divide ratio	8/9, 16/17 or 32/33
Reference divider	R	Reference counter divide ratio	5 to 4095
	f_r	Reference frequency	Option
	CP	Charge pump type	H type (high-speed sync) or L type (Low sensitivity)
ES request date/qty.		Typically 4 weeks from spec. fix to the first ES.	
CS request date/qty.		—	
MP request date/qty.		—	
Customer comments			

MB15C700 series

FUJITSU LIMITED

For further information please contact:

Japan

FUJITSU LIMITED
Corporate Global Business Support Division
Electronic Devices
KAWASAKI PLANT, 4-1-1, Kamikodanaka,
Nakahara-ku, Kawasaki-shi,
Kanagawa 211-8588, Japan
Tel: +81-44-754-3763
Fax: +81-44-754-3329

<http://www.fujitsu.co.jp/>

North and South America

FUJITSU MICROELECTRONICS, INC.
3545 North First Street,
San Jose, CA 95134-1804, U.S.A.
Tel: +1-408-922-9000
Fax: +1-408-922-9179

Customer Response Center
Mon. - Fri.: 7 am - 5 pm (PST)
Tel: +1-800-866-8608
Fax: +1-408-922-9179

<http://www.fujitsumicro.com/>

Europe

FUJITSU MICROELECTRONICS EUROPE GmbH
Am Siebenstein 6-10,
D-63303 Dreieich-Buchsschlag,
Germany
Tel: +49-6103-690-0
Fax: +49-6103-690-122

<http://www.fujitsu-fme.com/>

Asia Pacific

FUJITSU MICROELECTRONICS ASIA PTE. LTD.
#05-08, 151 Lorong Chuan,
New Tech Park,
Singapore 556741
Tel: +65-281-0770
Fax: +65-281-0220

<http://www.fmap.com.sg/>

Korea

FUJITSU MICROELECTRONICS KOREA LTD.
1702 KOSMO TOWER, 1002 Daechi-Dong,
Kangnam-Gu, Seoul 135-280
Korea
Tel: +82-2-3484-7100
Fax: +82-2-3484-7111

F0007

© FUJITSU LIMITED Printed in Japan

All Rights Reserved.

The contents of this document are subject to change without notice. Customers are advised to consult with FUJITSU sales representatives before ordering.

The information and circuit diagrams in this document are presented as examples of semiconductor device applications, and are not intended to be incorporated in devices for actual use. Also, FUJITSU is unable to assume responsibility for infringement of any patent rights or other rights of third parties arising from the use of this information or circuit diagrams.

The contents of this document may not be reproduced or copied without the permission of FUJITSU LIMITED.

FUJITSU semiconductor devices are intended for use in standard applications (computers, office automation and other office equipments, industrial, communications, and measurement equipments, personal or household devices, etc.).

CAUTION:

Customers considering the use of our products in special applications where failure or abnormal operation may directly affect human lives or cause physical injury or property damage, or where extremely high levels of reliability are demanded (such as aerospace systems, atomic energy controls, sea floor repeaters, vehicle operating controls, medical devices for life support, etc.) are requested to consult with FUJITSU sales representatives before such use. The company will not be responsible for damages arising from such use without prior approval.

Any semiconductor devices have inherently a certain rate of failure. You must protect against injury, damage or loss from such failures by incorporating safety design measures into your facility and equipment such as redundancy, fire protection, and prevention of over-current levels and other abnormal operating conditions.

If any products described in this document represent goods or technologies subject to certain restrictions on export under the Foreign Exchange and Foreign Trade Control Law of Japan, the prior authorization by Japanese government should be required for export of those products from Japan.