

MB4509 TELEPHONE IC

TELEPHONE IC

The Fujitsu MB4509, utilizing Bipolar technology, is a telephone IC. The MB4509 has an on-chip speech network circuit, tone ringer circuit, dialer circuit.

- On-chip speech network circuit, tone ringer circuit, dialer circuit
- On-hook dialing function
- Redial function
- Tone ringer tone selection function
- 64-pin plastic flat package

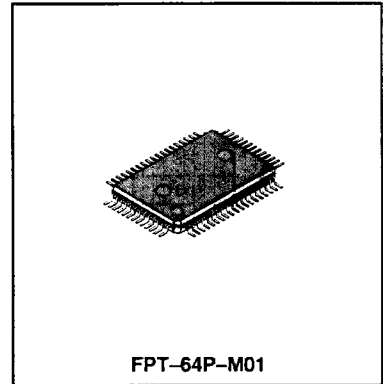

6

ABSOLUTE MAXIMUM RATINGS (See NOTE) (TA = 25 °C)

Parameter		Symbol	Value	Unit
Transmit Section	Supply Voltage	V _{LM}	21	V
	Supply Current	I _{LM}	160	mA
Tone Ringer	Supply Voltage	V _{TM}	21	V
	Supply Current	I _{TM}	10	mA
Operating Ambient Temperature		T _A	-30 to 60	°C
Storage Temperature		T _{STG}	-55 to 125	°C

NOTE: Permanent device damage may occur if the above **Absolute Maximum Ratings** are exceeded. Functional operation should be restricted to the conditions as detailed in the operational sections of this data sheet. Exposure to absolute maximum rating conditions for extended periods may affect device reliability.

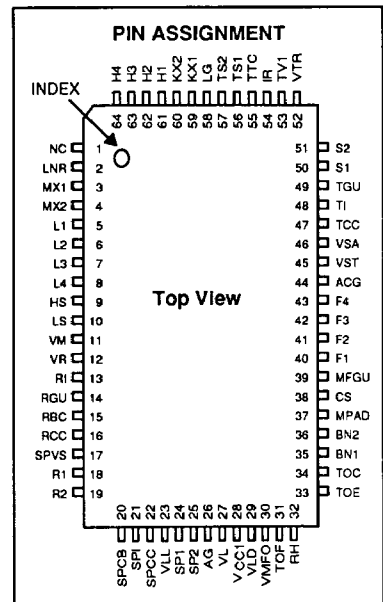

The device contains circuitry to protect the inputs against damage due to high static voltages or electric fields. However, it is advised that normal precautions be taken to avoid application of any voltage higher than maximum rated voltages to this high impedance circuit.

Table 1 — PIN ASSIGNMENTS

Pin No.	Symbol	Pin No.	Symbol	Pin No.	Symbol	Pin No.	Symbol
1	NC	17	SPVS	33	TOE	49	TGU
2	LNR	18	R1	34	TOC	50	S1
3	MX1	19	R2	35	BN1	51	S2
4	MX2	20	SPCB	36	BN2	52	VTR
5	L1	21	SPI	37	MPAD	53	TV1
6	L2	22	SPCC	38	CS	54	IR
7	L3	23	VLL	39	MFGU	55	TTC
8	L4	24	SP1	40	F1	56	TS1
9	HS	25	SP2	41	F2	57	TS2
10	LS	26	AG	42	F3	58	LG
11	VM	27	VL	43	F4	59	KX1
12	VR	28	V _{CC1}	44	ACG	60	KX2
13	RI	29	VLD	45	VST	61	H1
14	RGU	30	VMFO	46	VSA	62	H2
15	RBC	31	TOF	47	TCC	63	H3
16	RCC	32	RH	48	TI	64	H4

6

RECOMMENDED OPERATING CONDITIONS (TA = 25 °C)

Parameter		Symbol	Value	Unit
Transmit Section	Supply Voltage	V _{LM}	20 max	V
	Supply Current	I _{LM}	20 to 150	mA
Tone Ringer	Supply Voltage	V _{TM}	20 max	V
	Supply Current	I _{TM}	7 max	mA

ELECTRICAL CHARACTERISTICS (f = 1.0 kHz; TA = 25 °C)

Parameter	Symbol	Measurement Condition	Values			Unit	
			I _L (mA)	Min	Typ		Max
DC Voltage	V _{L11}	Speeching	20	2.3	2.6	2.9	V
	V _{L12} *		90	4.95	5.70	6.45	V
	V _{L21}	Dialing	20	4.4	4.7	5.0	V
	V _{L22} *		90	6.3	7.8	9.3	V
Transmit Supply Voltage	V _{CC1}	Speeching	20	1.57	1.70	1.90	V
Telephone AC Impedance	Z _{TEL1} *	Speech handset Loudspeaker	30.90	420	600	780	Ω
	Z _{TEL2} *		30.90	420	600	780	Ω
Transmit Voltage Gain	G _{TV1}	AUTO, V _i = -50 dBV	30	42.3	44.8	47.3	dB
	G _{TV2}	MAN, V _i = -50 dBV	30	40.6	43.3	46.0	dB
	G _{TV3}	AUTO, V _i = -50 dBV	90	40.9	43.8	46.7	dB
Transmit Dynamic Range	G _{TD1}	Distortion attenuation is 20 dB or more.	30	0.5	3.0		dBV
	G _{TD2}		90	4.5	6.0		dBV
Transmission Background Noise	NT*					-56	dBV
Reception Gain	G _{RV1}	AUTO, V _i = -30 dBV	30	11.6	14.1	16.6	dB
	G _{RV2}	MAN, V _i = -30 dBV	30	5.4	8.1	10.8	dB
	G _{RV3}	AUTO, V _i = -30 dBV	90	5.7	8.6	11.5	dB
Reception Dynamic Range	G _{RD1}	Attenuation is 20 dB or more.	30	-5.5	-1.0		dBV
	G _{RD2}		90	-1.0	0.0		dBV
Balancing Network Threshold Current	I _{FN}	Far to near		43	55	70	mA
	I _{NF}	Near to far		32.5	42.5	52.5	mA
	I _H	Hysteresis		9.0	12.5	27.5	mA
Speaker Gain	G _{SV}	V _i = -30 dBV	30	10.5	15.5	20.5	dB
Speaker Dynamic Range	G _{SD1}	Distortion attenuation is 20 dB or more.	30	-15	-12		dBV
	G _{SD2}		90	-4	-1		dBV
* Tone Switch	LT*	For transmission V _i = -45 dBV	30	40	49		dB
	LS*	For loud drive V _i = -50 dBV	30	50	57		dB
	V _{TH}	Threshold level	30	-73	-69	-65	dBV
	t _{RL}	V _i = -50 dBV	30		7	10	ms

Note: * Design guarantee

ELECTRICAL CHARACTERISTICS (Continued)

Parameter	Symbol	Measurement Condition	Values			Unit	
			I _L (mA)	Min	Typ		Max
Oscillation Frequency Deviation	%f L1	fL ₁ = 697Hz	90	-0.9		0.9	%
	%f L2	fL ₂ = 770 Hz		-0.9		0.9	%
	%f L3	fL ₃ = 852 Hz		-0.9		0.9	%
	%f L4	fL ₄ = 941 Hz		-0.9		0.9	%
	%f H1	fH ₁ = 1209 Hz		-0.9		0.9	%
	%f H2	fH ₂ = 1336 Hz		-0.9		0.9	%
	%f H3	fH ₃ = 1477 Hz		-0.9		0.9	%
	%f H4	fH ₄ = 1633 Hz		-0.9		0.9	%
Signal Level (button 8)	V _{PL11} V _{PH11}	AUTO PAD	30	-9.4 -8.4	-7.5 -6.5	-5.6 -4.6	dBm dBm
	V _{PL12} V _{PH12}	MAN. PAD	30	-11.9 -10.9	-10.0 -9.0	-8.1 -7.1	dBm dBm
	V _{PL13} V _{PH13}	AUTO PAD	90	-11.9 -10.9	-10.0 -9.0	-8.1 -7.1	dBm dBm
Contact Resistance	R _{on} *	Transmit : OK	20			10	k Ω
	R _{off} *	Transmit : NO	20	500			k Ω
Distortion Attenuation (button 8)	D _{L20} * D _{H20} *	AUTO PAD	20	23 23	30 30		dB dB
	D _{L90} D _{H90}	AUTO PAD	90	26 26	30 30		dB dB
Switch Interface Guard Time	t _{PR} *	Rise * 1	30	2		6	ms
	t _{PD} *	Fall	30	25	30	35	ms
Out-band Undesired Signal Level	V _{PS1} *	(4 through 8 kHz)	20			P-20	dB
	V _{PS2} *	(8 through 12 kHz)	20			P-40	dB
	V _{PS3} *	(12 kHz or more)	20			P-60	dB
Signal Level Increase	V _{PU} *		30	2.5	3.5	4.5	dB
MFO ON Resistance	R _{MFO}		30	1.7	3.2	4.4	Ω
CS Terminal ON Voltage	V _{CS} *	Sink current 1 mA	30			0.3	V
Tone Ringer Start Current	I _{TR}			1.5	2.25	3.0	mA
Guard Time	t _{TS} *			21	43	65	ms
Tone Ringer Output Voltage	V _{TR}	I _{TR} = 5 mA Tone: FA		30	34		V _{p-p}
Transmit Voltage Gain Increase	V _{TU} *	V _i = -50 dBV	30	3.0	4.0	5.0	dB
Reception Voltage Gain Increase	T _{RU} *	V _i = -50 dBV	30	3.0	4.0	5.0	dB

Note: * Design guarantll

*1 2ms No transmit.

6ms Transmit.

SYSTEM TEST SETUP

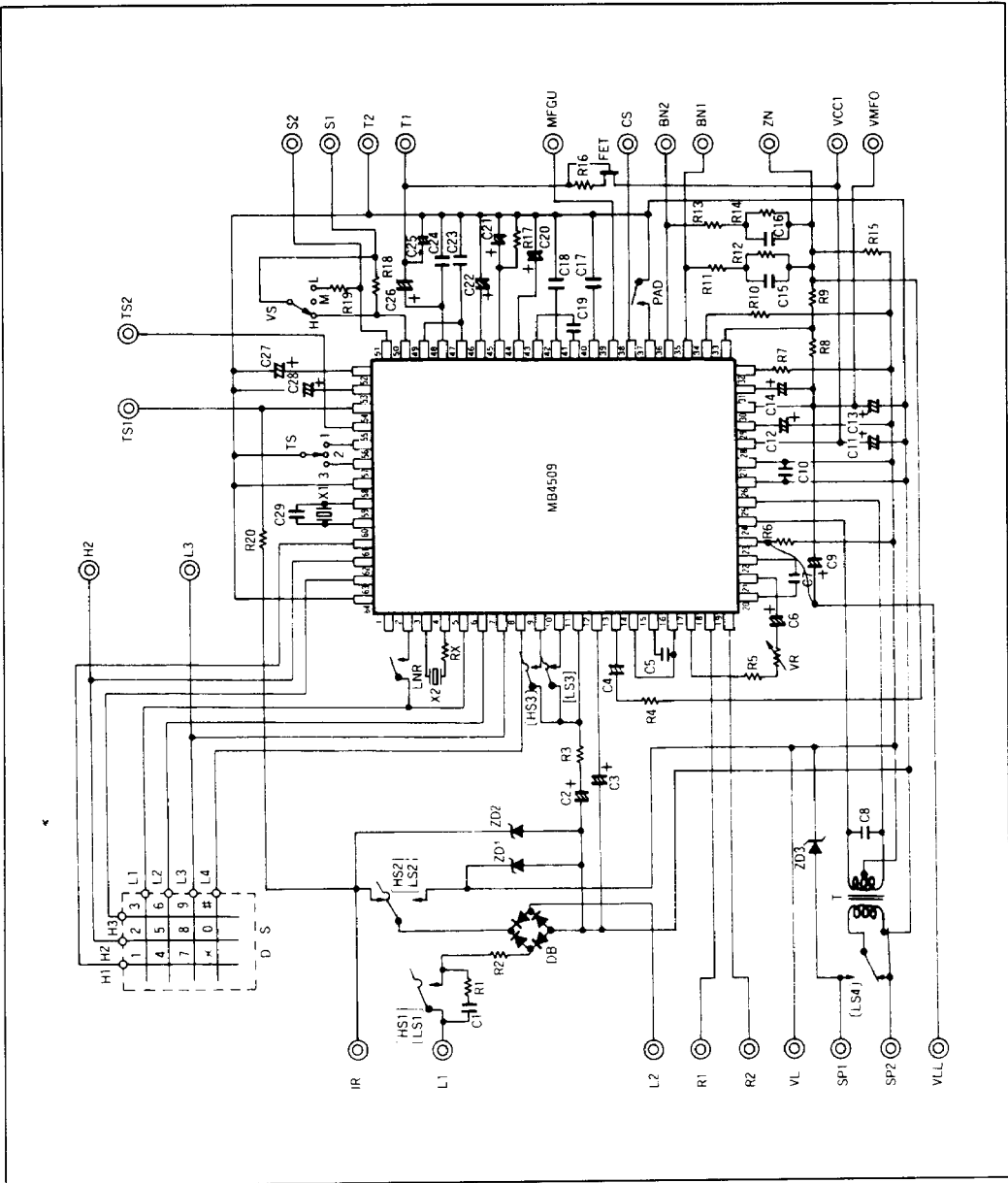

PARTS LIST FOR SYSTEM TEST SETUP

Symbol	Value	Symbol	Value
R1	150 Ω F, 1/2 W or more	C11	220 μ F, 3 V or more, $\pm 5\%$
R2	1.0 Ω F, 1/4 W or more	C12	100 μ F, 5 V or more, $\pm 5\%$
R3	180 Ω F, 1/16 W or more	C13	2.2 μ F, 10 V or more, $\pm 5\%$
R4	470 Ω F, 1/16 W or more	C14	22 μ F, 5 V or more, $\pm 5\%$
R5	2.2 k Ω F, 1/16 W or more	C15	0.015 μ F, 20 V or more, $\pm 1\%$
R6	1.3 k Ω F, 1/16 W or more	C16	0.027 μ F, 20 V or more, $\pm 1\%$
R7	56 Ω F, 1/2 W or more	C17	0.015 μ F, 5 V or more, $\pm 1\%$
R8	18 Ω F, 1/4 W or more	C18	1500 pF, 5 V or more, $\pm 1\%$
R9	180 Ω F, 1/16 W or more	C19	0.022 μ F, 5 V or more, $\pm 1\%$
R10	12 Ω F, 1/4 W or more	C20	47 μ F, 3 V or more, $\pm 5\%$
R11	1.5 k Ω F, 1/16 W or more	C21	0.22 μ F, 3 V or more, $\pm 1\%$
R12	6.2 k Ω F, 1/16 W or more	C22	1.5 μ F, 3 V or more, $\pm 1\%$
R13	2.4 k Ω F, 1/16 W or more	C23	150 pF, 3 V or more, $\pm 5\%$
R14	8.2 k Ω F, 1/16 W or more	C24	100 pF, 3 V or more, $\pm 5\%$
R15	5.6 k Ω F, 1/16 W or more	C25	0.15 μ F, 3 V or more, $\pm 1\%$
R16	3.0 k Ω F, 1/16 W or more	C26	0.47 μ F, 3 V or more, $\pm 1\%$
R17	4.7 M Ω F, 1/16 W or more	C27	33 μ F, 36 V or more, $\pm 5\%$
R18	12 k Ω F, 1/16 W or more	C28	2.2 μ F, 3 V or more, $\pm 5\%$
R19	820 Ω F, 1/16 W or more	C29	82 pF, 3 V or more, $\pm 5\%$
R20	270 Ω F, 1/4 W or more	DB	S1VB40Z equivalent
RX	300 Ω F, 1/16 W or more (TA = 25 °C)	ZD1	1Z16, ST06-16 equivalent
C1	0.9 μ F, 250 V $\pm 5\%$	ZD2	1Z27, ST06-27 equivalent
C2	0.012 F, 3 V or more	ZD3	Zener voltage 11 V, Power 1 W or more
C3	10 μ F, 10 V or more, $\pm 5\%$	X1	f = 32.768 kHz
C4	1.1 μ F, 5 V or more, $\pm 1\%$	X2	f = 3.579545 MHz
C5	100 pF, 3 V or more, $\pm 5\%$	T	1.2 k Ω : 32 Ω , 20 mW. Loss = 1 dB.
C6	1.0 μ F, 5 V or more, $\pm 1\%$	VR	50 k Ω /B, 30 mW
C7	100 pF, 3 V or more, $\pm 5\%$	HS 1 to 4	
C8	0.047 μ F, 5 V or more, $\pm 1\%$	LS 1 to 5	
C9	220 μ F, 10 V or more, $\pm 5\%$	FET	2SK208-0 equivalent (ID = 200 μ A)
C10	4700 pF, 20 V or more, $\pm 5\%$		

TEST PROCEDURES

Fig 1. — CS TEST SETUP

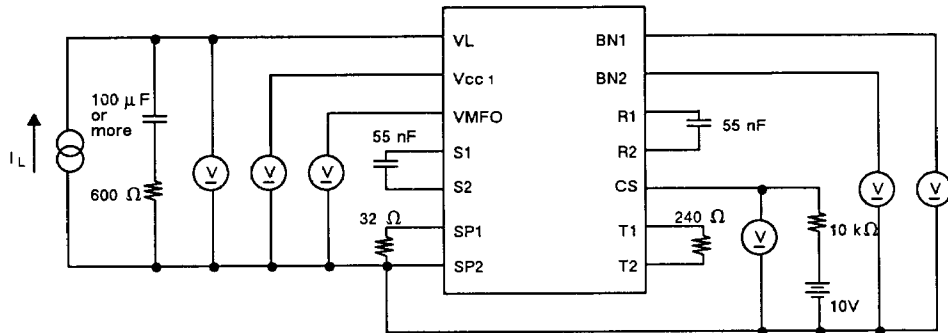

CONDITIONS:

- I_L = Current source [AC impedance is 60 k Ω or more, (1 kHz, 30 mA)]
 V = DC voltmeter
 Hook switch HS = On; LS = Off; PAD (A), unless otherwise specified.

PROCEDURES:

- Step 1: Telephone DC Voltage (during dialing).
 With two diagonally adjacent buttons pressed (no signal).
- Step 2: Balancing Network Changing.
 I_{FN} : I_L (mA) at which V_{BN1} changes from 1.5 V to 3.5 V or more when I_L is changed from 30 mA to 70 mA.
 I_{NF} : I_L (mA) at which V_{BN1} changes from 3.5 V to 1.5 V or less when I_L is changed from 70 mA to 30 mA.
- Step 3: MFO On Resistance.
 $RMFO = VMFO / I_L$ ($I_L = 30\text{mA}$)
- Step 4: CS Terminal On Voltage.
 Voltage between CS and Sub when button 8 is pressed.
- Step 5: Tolerance of load impedance at each terminal is $\pm 1\%$ (common to all test set-ups).

TEST PROCEDURES (Continued)

Fig. 2 — TRANSMIT TEST SETUP

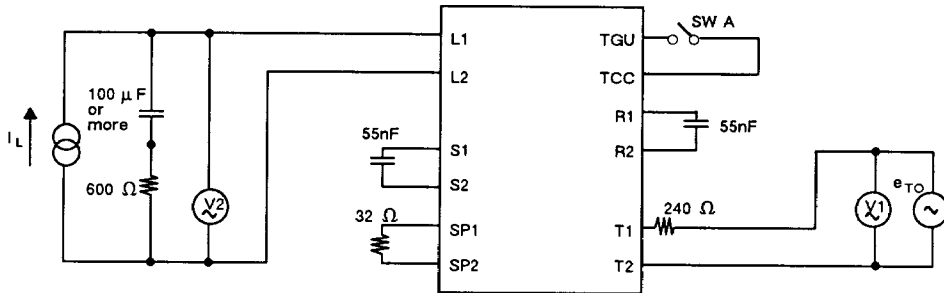

CONDITIONS:

- e = Oscillator [Both output impedance and DC resistance are less than 4Ω ($f = 1 \text{ kHz}$)]
- I = Current source [AC impedance is $60 \text{ k}\Omega$ or more (1 kHz , 30 mA)]
- V1 and V2 = AC voltmeters

Hook switch HS = On, LS = Off, PAD (A), unless otherwise specified.

Transmit amplifier voltage gain $G_{TV} = 20 \log (V2/V1) \text{ dB}$.

PROCEDURES:

- Step 1: Gain Increase.
Measure increase in AC signal level of V2 when SW A is off.
- Step 2: Dynamic Range.
Measure distortion attenuation of 20 dB or more when output signal level is set to a prescribed value.
- Step 3: Background Noise.
Measure output signal level with no transmit input signal.

TEST PROCEDURES (Continued)

Fig. 3 — TRANSMIT TEST SETUP

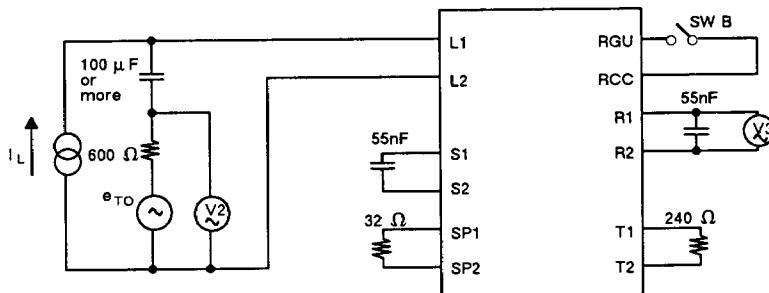

CONDITIONS:

- e_{TO} = Oscillator [Both output impedance and DC resistance are less than 4Ω ($f = 1$ kHz)]
- I_L = Current source [AC impedance is 60 k Ω or more (1 kHz, 30 mA)]
- V_2 and V_3 = AC voltmeters

Hook switch HS = On, LS = Off, PAD (A), unless otherwise specified.

Reception amplifier voltage gain $G_{RV} = 20 \log (V_3/V_2)$ dB.

PROCEDURES:

- Step 1: Gain Increase.
Measure AC signal increase level of V_3 when SW B is off.
- Step 2: Dynamic Range.
Measure distortion attenuation of 20 dB or more when output signal level is set to a prescribed value.

TEST PROCEDURES (Continued)

Fig. 4 — SPEAKER TEST SETUP

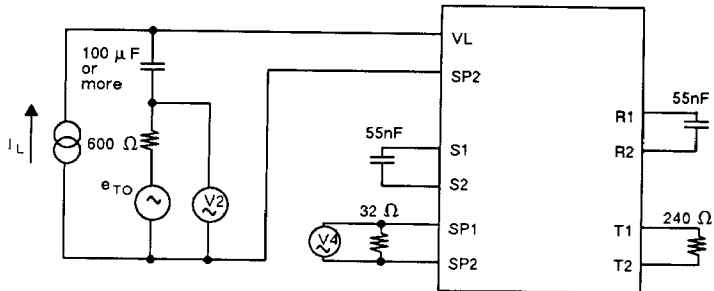

CONDITIONS:

- e_{TO} = Oscillator [Both output impedance and DC resistance are less than 4Ω ($f = 1$ kHz)]
- I_L = Current source [AC impedance is $60\text{ k}\Omega$ or more (1 kHz, 30 mA)]
- V_2 and V_4 = AC voltmeters
- Speaker volume adjustment = maximum
- Hook switch HS = Off, LS = On, PAD (A), unless otherwise specified.
- Speaker amplifier voltage gain $G_{SV} = 20 \log (V_4/V_2)$ dB.

PROCEDURE:

Dynamic Range.

Measure distortion attenuation of 20 dB or more when output signal level is set to a prescribed value.

TEST PROCEDURES (Continued)

Fig. 5 — VOICE SWITCH ATTENUATION TEST SETUP #1

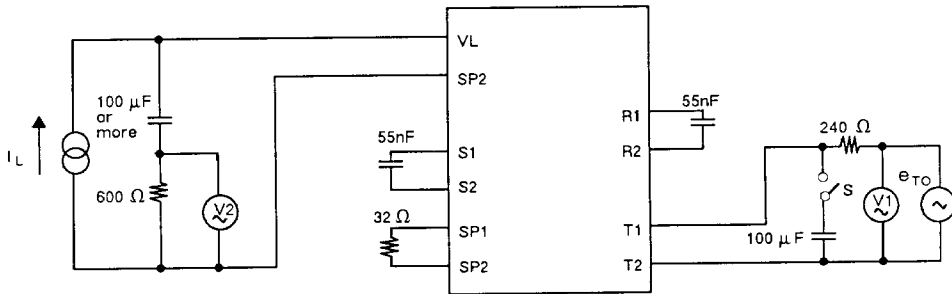

CONDITIONS:

- e_{TO} = Oscillator [Both output impedance and DC resistance are less than 4Ω ($f = 1$ kHz)]
- I_L = Current source [AC impedance is 60 k Ω or more (1 kHz, 30 mA)]
- V_1 and V_2 = AC voltmeters

PROCEDURES:

Step 1: Transmit Insertion Loss.

$LTV = GTV(1) - GTV(4)$, ($IL = 30$ mA and $V_i = -45$ dBV)
 $G_{TV}(1)$ = total gain of transmit system when handset is used.
 $G_{TV}(4)$ = total gain of transmit system with loudspeaker reception.

Step 2: Transmit Rise Time.

Hook switch HS = On; LS = On; PAD (A); ($IL = 30$ mA; $V_i = -50$ dBV)

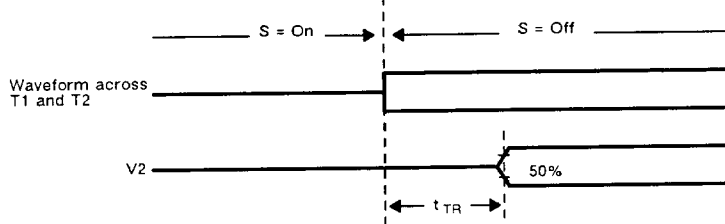

Step 3: Threshold Level (V_{TH})

V_i value at which transmit gain changes discontinuously, that is, when V_i is changed from small to large value in handset and loudspeaker (LS, HS = On).

TEST PROCEDURES (Continued)

Fig. 6 — VOICE SWITCH ATTENUATION TEST SETUP #2

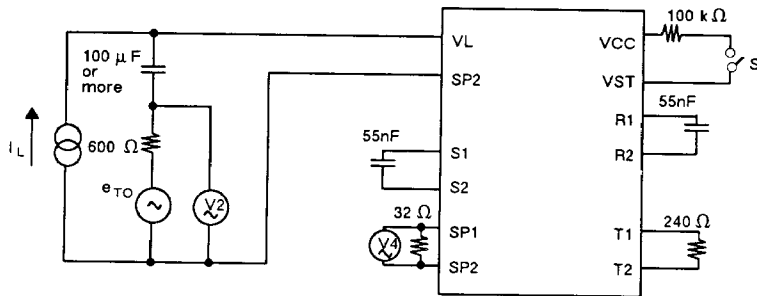

CONDITIONS:

- e_{TO} = Oscillator [Both output impedance and DC resistance are less than 4Ω ($f = 1$ kHz)]
- I_L = Current source [AC impedance is $60\text{ k}\Omega$ or more (1 kHz, 30 mA)]
- V_2 and V_4 = AC voltmeters

PROCEDURE:

Speaker Insertion Loss.

$$LSV = GSV - GSV1 \quad (I_L = 30\text{mA}, V_2 = 50 \text{ dBV})$$

GSV = total gain of speaker system with loudspeaker reception

$GSV1$ = total gain of speaker system with handset reception ($S = \text{On}$)

6

TEST PROCEDURES (Continued)

Fig. 7 — DIAL SIGNAL TEST SETUP

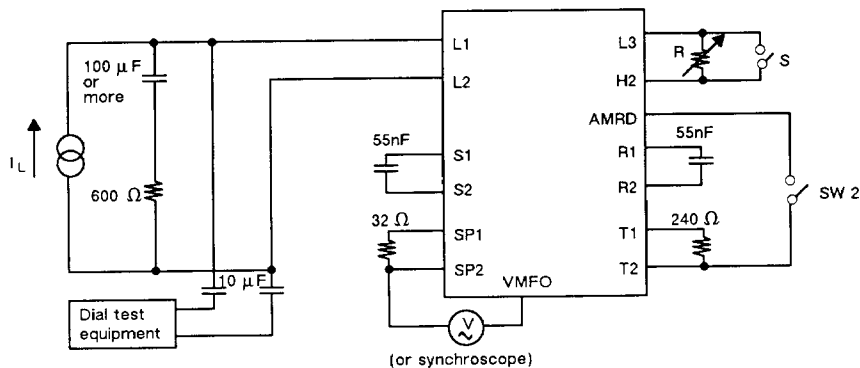

TEST EQUIPMENT REQUIRED:

- 600 P signal measuring equipment (NTT standards 1212)
- PB signal distortion attenuation measuring equipment (NTT standards 1214) or equivalent

PROCEDURES:

- Step 1: Contact Resistance.
Set R; check whether dialing tone signal is on or off (S = Off, SW 2 = On).
- Step 2: Guard Time (R = ∞, SW 2 = Off).
Rise guard time : Time in which VMFO builds up from S = On state.
Fall guard time : Time in which VMFO falls from S = Off state.
- Step 3: Signal Level Increase (R = ∞, S = Off).
Signal level variation when SW 2 is set from On to Off.

REDIALING TEST:

- Step 1: Set HS and LS to On, dial 16 arbitrary digits, and hang up. Now, when the phone is taken off-the-hook, the 16-digit signal must be correctly transmitted if the redial button is pressed.
- Step 2: With the same switching as Step 1, press any digit. The arbitrary digit and the second through sixteenth digits of Step 1 (16 digits in all) must be correctly transmitted when the redial button is pressed.
- Step 3: Repeat the switching arrangement of Step 1 and press any two digits. The resulting dial tone (17 digits in all) must not be transmitted.

TEST PROCEDURES (Continued)

Fig. 8 — TONE RINGER TEST SETUP

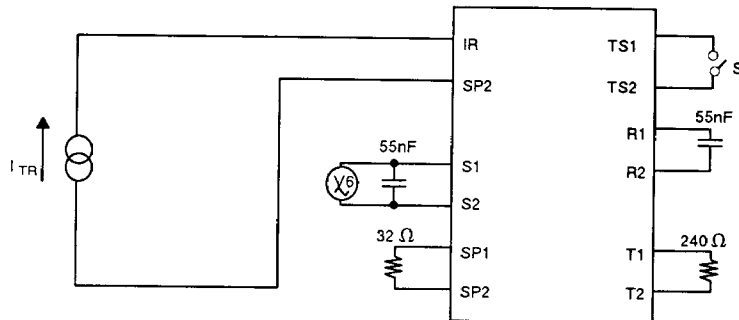

CONDITIONS:

- Hook Switch : Incoming call waiting state (HS = Off, LS = Off)
- Tone Ringer Volume : Maximum
- Tone Type : FA
- V_6 = AC Voltmeter

PROCEDURES:

- Step 1: Guard Time.
With DC applied and switch S closed, check that ringing stops after switch closure.
- Step 2: Output Voltage.
With $I_{TR} = 5 \text{ mA}$, check that V_6 voltage level.
- Step 3: Ringing Start Current.
 I_{TR} at which V_6 exceeds 8Vp-P when I_{TR} is increased from 0V.

TYPICAL CHARACTERISTICS CURVES

Fig. 9 - VOLTAGE VS. SUPPLY CURRENT

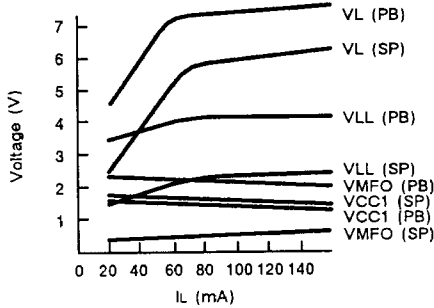

Fig. 10 - VMFO OUTPUT VOLTAGE VS. SUPPLY CURRENT

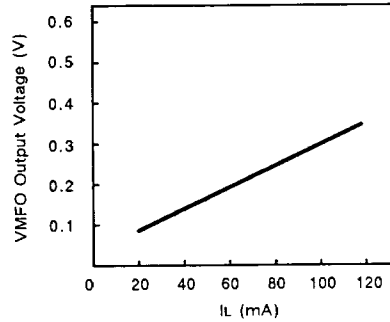

Fig. 11 - TELEPHONE AC IMPEDANCE VS. SUPPLY CURRENT

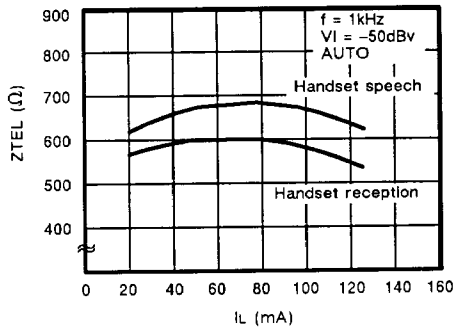

Fig. 12 - TRANSMIT TOTAL GAIN VS. SUPPLY CURRENT

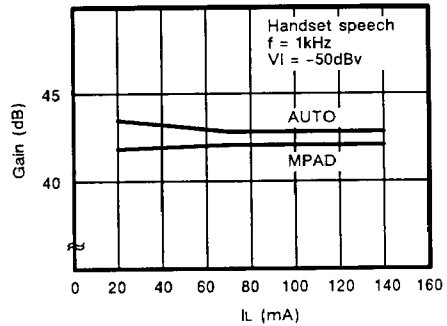

Fig. 13 - TRANSMIT TOTAL GAIN VS. FREQUENCY

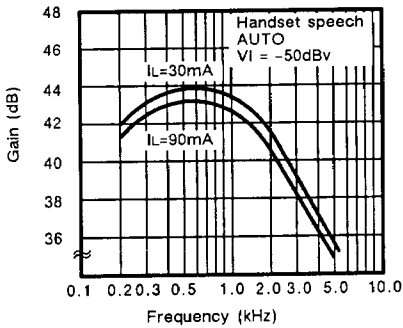
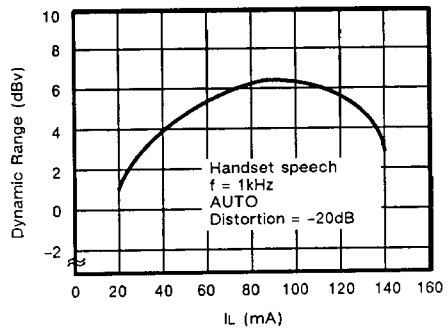

Fig. 14 - TRANSMIT DYNAMIC RANGE VS. SUPPLY CURRENT



6

TYPICAL CHARACTERISTICS CURVES (Continued)

Fig. 15 - RECEPTION TOTAL GAIN VS. SUPPLY CURRENT

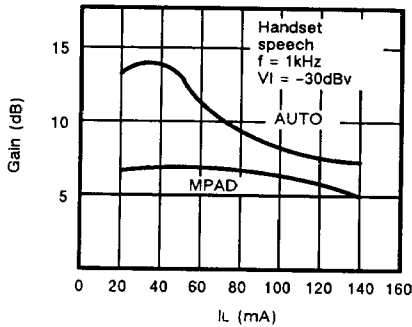

Fig. 16 - RECEPTION TOTAL GAIN VS. FREQUENCY

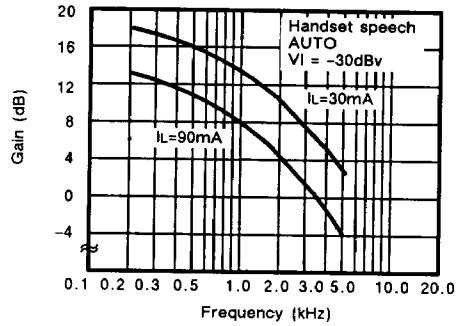

Fig. 17 - RECEPTION DYNAMIC RANGE VS. SUPPLY CURRENT

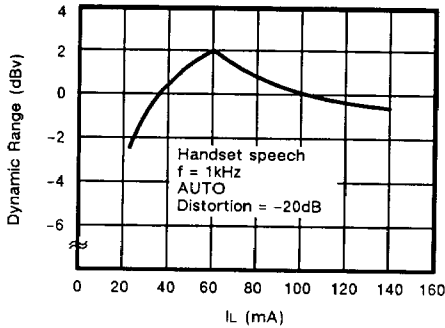

Fig. 18 - SPEAKER TOTAL GAIN VS. SUPPLY CURRENT

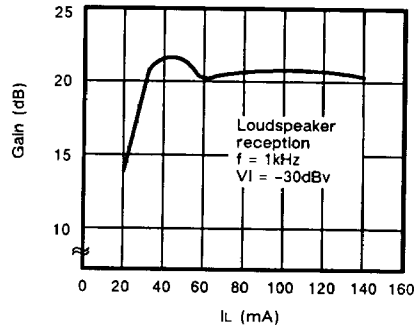

Fig. 19 - SPEAKER TOTAL GAIN VS. FREQUENCY

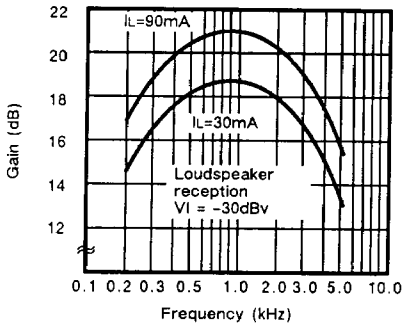
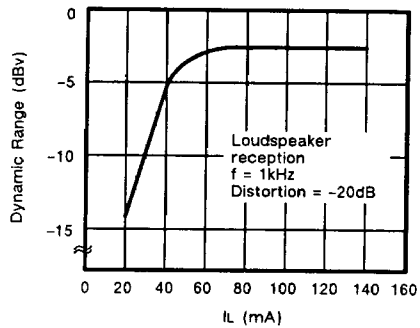

Fig. 20 - SPEAKER DYNAMIC RANGE VS. SUPPLY CURRENT



6

TYPICAL CHARACTERISTICS CURVES (Continued)

Fig. 21 - VOICE SWITCH THRESHOLD VS. SUPPLY CURRENT

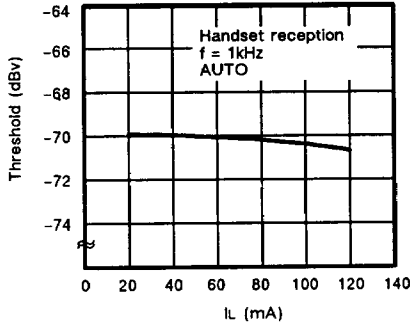

Fig. 22 - VOICE SWITCH THRESHOLD VS. FREQUENCY

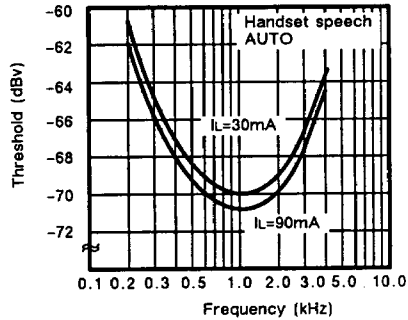

Fig. 23 - VOICE SWITCH RISE TIME VS. SUPPLY CURRENT

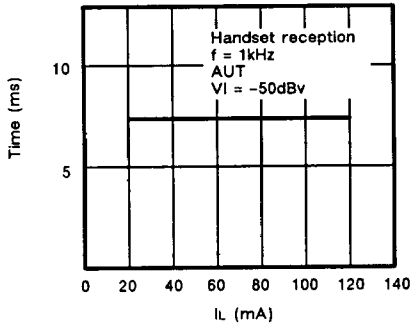

Fig. 24 - VOICE SWITCH TRANSMIT INSERT LOSS VS. SUPPLY CURRENT

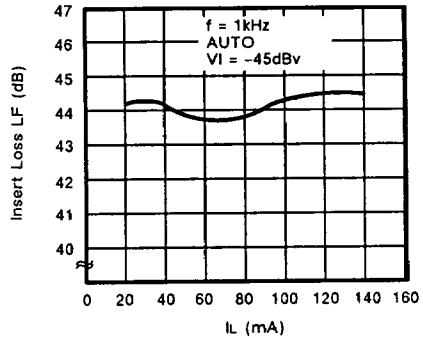

Fig. 25 - VOICE SWITCH SPEAKER INSERT LOSS VS. SUPPLY CURRENT

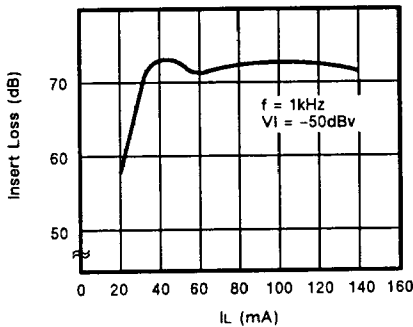
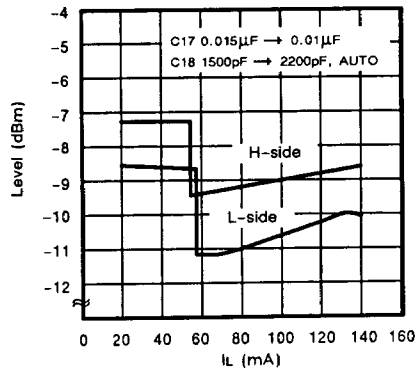

Fig. 26 - PB SIGNAL LEVEL VS. SUPPLY CURRENT



TYPICAL CHARACTERISTICS CURVES (Continued)

Fig. 27 - PB SIGNAL LEVEL VS. SUPPLY CURRENT

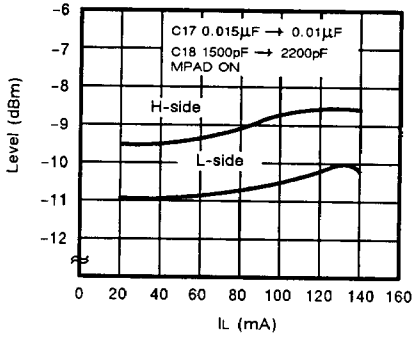

Fig. 28 - DISTORTION ATTENUATION VS. SUPPLY CURRENT

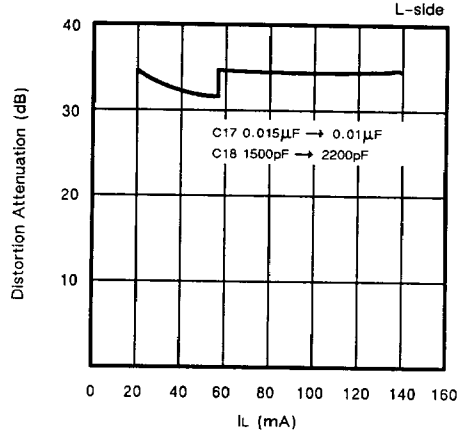

Fig. 29 - TONE RINGER OUTPUT VOLTAGE VS. SUPPLY CURRENT

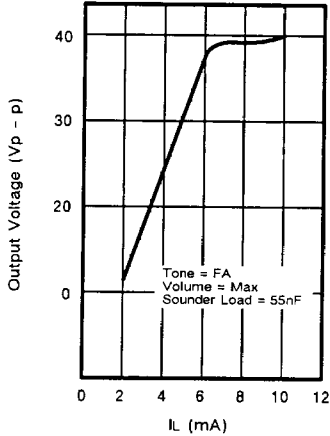

Fig. 30 - SWITCH INTERFACE GUARD TIME VS. SUPPLY CURRENT

