

16-BIT A/D AND D/A CONVERTER

The Fujitsu MB87020 is a 50kSPS (Kilo Sample Per Second) 16-bit Analog-to-Digital and Digital-to-Analog converter fabricated by Fujitsu Advanced CMOS technology. AD or DA function is selected by MODE input.

The MB87020 is synchronous/asynchronous 8/16-bit oriented data interface in order to transfer data between any processor directly and easily, and also serial data can be managed.

- Conversion Mode Selectable: A to D or D to A
- High Resolution: 16-bit
- High Conversion Speed: 50 kSPS max.
- High Linearity: 12-bit
- Low Power Dissipation and Stand by Mode Available
- Microprocessor oriented 8/16-bit bus compatibility including interrupt request as conversion completion
- Serial Data Port Available
- On-chip Sample and Hold circuit for Analog Input/Output
- On-chip Reference Voltage Generator: 2.5V typ.
- External Reference Voltage can be used.
- Power Supply Voltage: $\pm 5V$
- Packag: 40-pin Plastic Dual In-Line Package

ABSOLUTE MAXIMUM RATINGS (See NOTE)

Rating	Symbol	Value	Unit
Power Supply Voltage	V_{DD}	-0.3 to +7.0	V
	V_{SS}	-7.0 to +3.0	V
Analog Input/Output Voltage	V_{TA}	$V_{SS}-0.3$ to $V_{DD}+0.3$	V
Digital Input/Output Voltage	V_{TD}	-0.3 to $V_{DD}+0.3$	V
Input/Output Current	I_T	-10 to +10	mA
Power Dissipation	P_D	500	mW
Storage Temperature	T_{STG}	-40 to +125	$^{\circ}C$
Ambient Operating Temperature	T_A	0 to +70	$^{\circ}C$

NOTE: Permanent device damage may occur if ABSOLUTE MAXIMUM RATINGS are exceeded. Functional operation should be restricted to the conditions as detailed in the operational sections of this data sheet. Exposure to absolute maximum rating conditions for extended periods may affect device reliability.

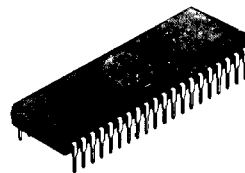

PLASTIC PACKAGE
DIP-40P-M01

(TOP VIEW)

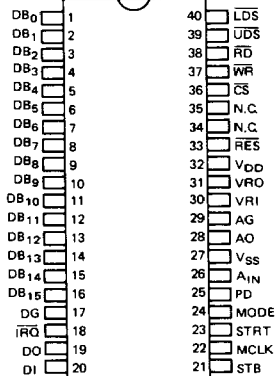

(DIP-40P-M01)

This device contains circuitry to protect the inputs against damage due to high static voltages or electric fields. However, it is advised that normal precautions be taken to avoid application of any voltage higher than maximum rated voltages to this high impedance circuit.

7

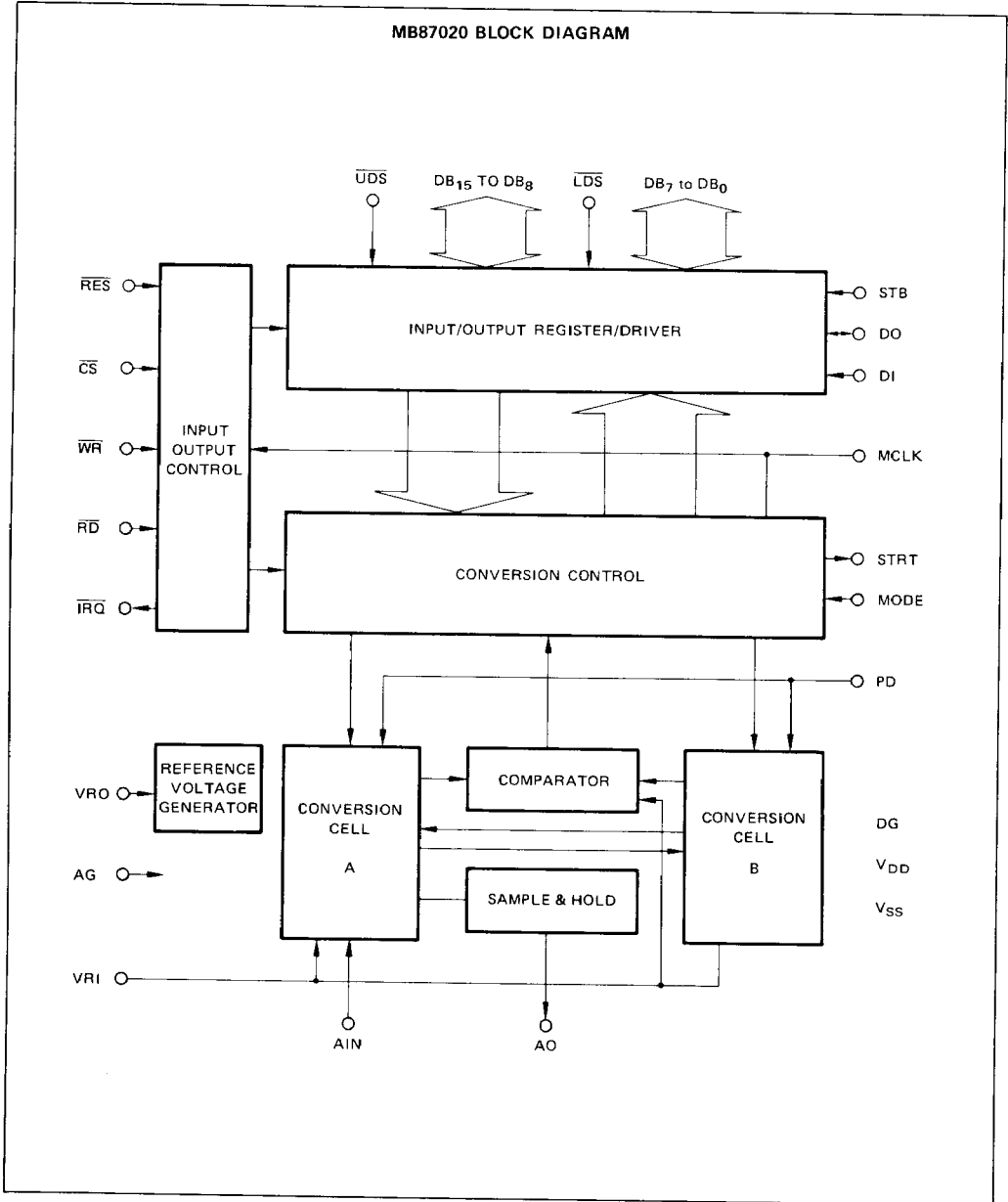

PIN DESCRIPTION

Pin Name	Pin No.	Description
V _{DD}	32	+5V Power Supply Input for Digital/Analog Circuit
V _{SS}	27	-5V Power Supply Input for Digital/Analog Circuit
DG	17	Digital Ground
AG	29	Analog Ground
VRI	30	External Reference Voltage Input. +2.5V typ. When the internal reference voltage is used, VRI and VRO should be connected together.
VRO	31	Internal Reference Voltage Output. +2.5V typ.
MODE	24	Conversion Mode Select Input: When MODE is high, A/D mode is selected. When MODE is low, D/A mode is selected.
PD	25	Stand-by Mode Select Input for Analog Circuit: When PD is high, Stand-by mode is selected. When PD is low, the normal operation is selected.
RES	33	Reset Input: When RES is low, all internal registers are reset and cleared. After power on, the reset operation is needed firstly.
MCLK	22	Conversion Clock Input: Conversion operation is synchronized with this clock.
A _{IN}	26	Analog Input for A/D Conversion: During STRT = H, this input data is sampled. During D/A conversion, this input pin is recommended to be tied with AG.
AO	28	Analog Output for D/A conversion: This output is updated after conversion, and keep the level until next completion of conversion.
DB ₀ to DB ₁₅	1 to 16	Parallel Data Input/Output: Can transmit A/D conversion data output or D/A conversion data input in 8- or 16-bit parallel. Due to three-state input, the pins are connected with microprocessor's bus directly. DB ₁₅ is MSB, DB ₀ is LSB. When connected with 8-bit bus, DB _n and DB _{n+8} are connected together, where n = 0 to 7.
DI	20	Serial Data Input: At the rising edge of STB, the 1-bit data is transferred to the LSB of the input/output register. (See Serial Data Transfer.)
DO	19	Serial Data Output: The MSB of the input/output register is output. At the falling edge of STB, the output is changed. (See Serial Data Transfer.)
STB	21	Strobe Signal Input for Serial Data Transfer: Using RD, CS, UDS and LDS, this input is internally gated. The rising edge of STB signal makes the output/input register shift by 1 bit. (See Serial Data Transfer.)
CS	36	Chip Select Input: When CS is low, RD and WR signals are effective.
WR	37	Data Write Input: When WR is low, stored data in DB ₀ to DB ₁₅ are shifted into the input/output register, and the rising edge of the input makes the data latched and ready for AD or DA conversion operation. After WR goes high, conversion starts at the rising edge of MCLK, or at the completion of previous conversion.
RD	38	Data Read Input: When RD is low, the stored data in output/input register are output at DB ₀ to DB ₁₅ .
UDS	39	High-order byte Select: When UDS is low, upper 8-bit data is transferred.
LDS	40	Low-order byte Select: When LDS is low, the lower 8-bit data is transferred.
STRT	23	Conversion Start Output: This output indicates conversion start. During the first clock cycle of conversion, it becomes high. When it is high for AD conversion, A _{IN} input is sampled.
IRQ	18	Interrupt Request Output as Conversion Completion: When conversion is completed, IRQ becomes low. When data transfer is instructed, (RD or WR) and CS, it becomes high. This output is an open-drain output.

Note: All digital input/output is TTL compatible.



OPERATIONAL DESCRIPTION

Input analog signal is converted to 16-bit digital signal or 16-bit digital signal is converted to analog signal. Either of function is selected by mode select pin. MB87020 can be used for either parallel I/O connection or serial I/O connection with micro-processor.

- Parallel I/O: Connected with μ P 80 series 8-bit, 68 series 8-bit, 8086 series 16-bit and 68000 series 16-bit.
- Serial I/O: It needs a less signal lines compared with parallel I/O.

We are going to describe how to control MB87020 through these signal lines and receiving/delivering digital data.

1) MODE CONTROL

MB87020 has three operational modes, D/A conversion mode, A/D conversion mode and analog circuit stand-by mode. These mode is selected by MODE and PD pin as listed below.

When the mode change is indicated during converting, the actual change of operational mode is done after the completion of conversion.

Mode	PD	Function
L	L	D/A conversion mode
	H	Analog circuit stand-by mode
H	L	A/D conversion mode
	H	Analog circuit stand-by mode

2) CONVERSION SEQUENCE

MB87020's conversion sequence comprises the following four process.

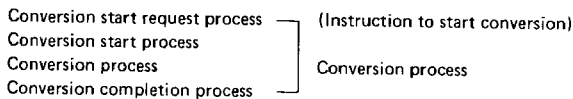





The above process are synchronized with MCLK signal, but data management can be independent from MCLK signal. And during conversion, next conversion start request can be provided.

Conversion start request process

Conversion start request is generated by the write cycle ($\overline{CS}=\overline{WR}=L$). After write cycle is completed (Rising edge of \overline{CS} or \overline{WR}), conversion start request is generated. During D/A mode, write is possible in using write cycle. 16-bit data is written from lower 8-bit then the upper 8-bit. After that conversion start request is generated.

\overline{LDS} AND \overline{UDS} IN WRITE CYCLE AND CONVERSION START REQUEST

Mode	\overline{LDS}	\overline{UDS}	Conversion Start Request	Data Xmit (Write)	Operation
D/A	L or 	L or 	Generated	DB ₀ to DB ₁₅	16-bit Parallel Write
	L or 	H	Not Generated	DB ₀ to DB ₇	Low-order Byte Write
	H	L or 	Generated	DB ₀ to DB ₁₅	High-order Byte Write
	H	H	Generated		Serial Data Conversion
A/D	Don't Care	Don't Care	Generated		A/D Conversion Start

: Transmission of High to Low to High.

CONVERSION START PROCESS

When conversion is requested to start, operational conversion starts at the next rising edge of MCLK clock. When previous conversion is not completed, following conversion is postponed until previous conversion is completed.

At this moment, START becomes High level in one clock cycle in order to indicate conversion start. During this moment, it is prohibited that $\overline{WR} = \overline{CS} = "L"$.

When A/D conversion, A_{IN} input is sampled at this moment.

7

CONVERSION PROCESS

16th MCLK clock cycles are needed for one conversion process. From second MCLK clock cycle, Write Mode is available and Conversion Start Request can be generated for the following conversion.

Write Mode can be repeated in this period, but only the last Conversion Start Request and the last written data are effective.

CONVERSION COMPLETION PROCESS

Conversion Process is completed after 16th MCLK clock cycles are passed from conversion starts.

At the end of conversion, \overline{IRQ} goes low to tell the completion of the conversion outside of the chip. This output is an open-drain output and connect to microprocessor and provides interrupt request signal to it.

When Write or Read Mode is executed, \overline{IRQ} goes high.

If Conversion Start Request is generated during conversion, the next conversion will start continuously after the current conversion is completed.

The result of D/A conversion is output at A₀ at this moment and output will remain at its last level.

More than 1 MCLK cycle passed after conversion is completed, the result of A/D conversion can be read out at DB₀ to DB₁₅ when $\overline{RD} = \overline{CS} = \overline{UDS} = \overline{LDS} = "L"$.

3) DATA TRANSMISSION

Data transmission between MB87020 and external is made through I/O register. I/O register does not control conversion directly, but they store A/D conversion results or D/A conversion data. Therefore, write/read are done freely except for the time of data transmission with register which directly control at the beginning and ending of conversion. Using this function, 8-bit parallel transmission, 8-bit serial transmission and data exchange during conversion are possible.

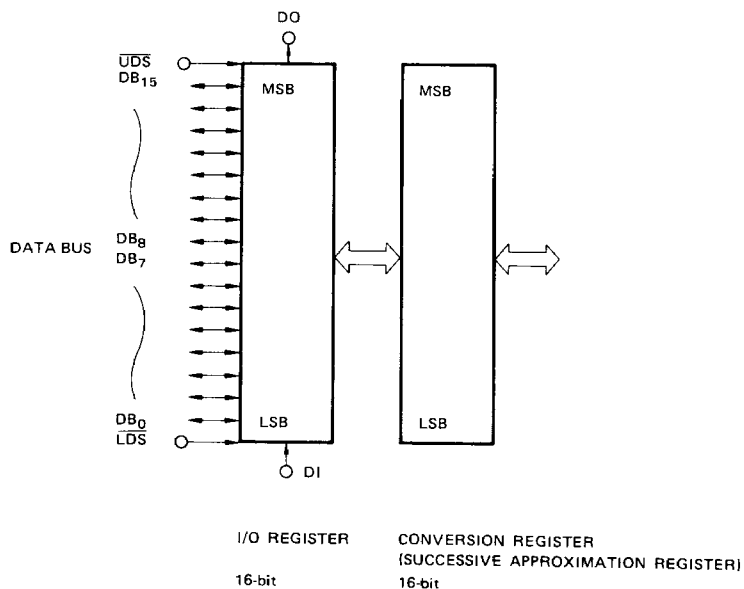

PARALLEL TRANSMISSION

Data is transmitted through DB₀ to DB₁₅ and controlled by \overline{CS} , \overline{WR} , \overline{RD} , \overline{UDS} and \overline{LDS} . In the transmission mode, it requires $\overline{CS} = \text{Low}$. And in the write mode to MB87020, it requires $\overline{WR} = \text{L}$ and read mode, $\overline{RD} = \text{L}$.

Upper byte (DB₈ to DB₁₅) transmission mode, it requires $\overline{UDS} = \text{L}$, lower byte (DB₇ to DB₀), $\overline{LDS} = \text{L}$. All required conditions are satisfied, data is transmitted. If no, data transmission mode is stopped and data is latched for write mode.

During A/D mode, data is not written regardless \overline{UDS} and \overline{LDS} .

I/O register stores latest A/D mode result or latest written data of D/A mode. During read cycle, it is possible to read out A/D conversion result and confirm D/A conversion result. Read/write of parallel data is controlled by control signal.

DATA CONTROL SIGNAL AND PARALLEL DATA TRANSMISSION

Mode	Resolution (Bit)	Read/Write	Data control signal					Condition		Conversion Start request	$\overline{IRQ}=L$ Clear	Operation		
			\overline{CS}	\overline{WR}	\overline{RD}	\overline{LDS}	\overline{UDS}	DB ₀ to DB ₇	DB ₈ to DB ₁₅					
A/D			L	L	X	X	X	HZ	HZ	Generated	Clear	A/D conversion start request		
				X			H	H	HZ	HZ	Not generated	Clear	Serial output	
	8	Read mode	L	H	L	L	H	Output	HZ	Not generated	Clear	Read out conversion result	Lower byte	
						H	L	HZ	Output	Not generated	Clear		Upper byte	
	16				L	L	Output	Output	Not generated	Clear		All byte		
D/A						H	H	HZ	HZ	Generated	Clear	Conversion start request of serial input data		
	8	Write mode	L	L	X	L	H	Input	HZ	Not generated	Clear	Read out conversion result	Lower byte	
						H	L	HZ	Input	Generated	Clear		Upper byte	
		16				L	L	Input	Input	Generated	Clear		All byte	
					X		H	H	HZ	HZ	Not generated	Clear	Serial input	
	8	Read mode	L	H	L	L	H	Output	HZ	Not generated	Clear	Confirm conversion result	Lower byte	
						H	L	HZ	Output	Not generated	Clear		Upper byte	
	16				L	L	Output	Output	Not generated	Clear		All byte		
X			L	H	H	X	X	HZ	HZ	Not generated	Not Clear			
			H	X	X	X	X	HZ	HZ	Not generated	Not Clear			

Note: X: Don't care



SERIAL TRANSMISSION

DI, DO, STB, \overline{RD} and \overline{CS} are used for serial transmission. \overline{UDS} , \overline{LDS} are settled as High, \overline{RD} , \overline{CS} indicate transmission timing.

A/D MODE (DO OUTPUT)

After conversion is completed, MSB is output at the first falling edge of MCLK clock.

When STB = H and $\overline{CS} = \overline{RD} = L$, from 2nd rising edge of MCLK clock, A/D conversion result is output serially from upper side synchronized with falling edge of STB clock.

The output after 16-bit output is not related to any of converter result.

Serial transmission is stop when STB = L and \overline{CS} or $\overline{RD} = H$.

D/A MODE (DI INPUT)

After conversion is completed, when $\overline{CS} = \overline{RD} = L$ at STB = H after one clock cycle, DI is sampled as MSB and after that DI is sampled from the MSB every rising edge of STB clock.

Transmission is completed when 16th DI is sampled as \overline{CS} or $\overline{RD} = H$ at STB = L.

When 2 pcs of MB87020 are used A/D, D/A mode separately with connecting DO of A/D and DI of D/A, STB, \overline{RD} , \overline{CS} direct transmission becomes possible.

If STB clock frequency is higher than MCLK clock, other signal or other conversion data can be transmitted by time sharing serially.

If no, STB requires H, DI requires H or L.

CONVERSION RANGE AND CODE

A/D MODE

Input Voltage	Output code (DB ₁₅ to DB ₀)															
$\geq +V_{REF}$	0	1	1	1	1	1	1	1	1	1	1	1	1	1	1	1
$+V_{REF} - 1LSB$	0	1	1	1	1	1	1	1	1	1	1	1	1	1	1	1
$+V_{REF}/2$	0	1	0	0	0	0	0	0	0	0	0	0	0	0	0	0
0	0	0	0	0	0	0	0	0	0	0	0	0	0	0	0	0
-1LSB	1	1	1	1	1	1	1	1	1	1	1	1	1	1	1	1
$-V_{REF}/2$	1	1	0	0	0	0	0	0	0	0	0	0	0	0	0	0
$-V_{REF} + 1LSB$	1	0	0	0	0	0	0	0	0	0	0	0	0	0	0	1
$\leq -V_{REF}$	1	0	0	0	0	0	0	0	0	0	0	0	0	0	0	1

Note: V_{REF} = VRI input voltage
 $1LSB = V_{REF}/2^{15}$
 Output code will not become 1000 0000 0000 0000 under $-V_{REF}$ input voltage.

D/A MODE

Input code (DB ₁₅ to DB ₀)																Output Voltage
0	1	1	1	1	1	1	1	1	1	1	1	1	1	1	1	$\geq +V_{REF} - 1LSB$
0	1	1	1	1	1	1	1	1	1	1	1	1	1	1	1	$+V_{REF} - 1LSB$
0	1	0	0	0	0	0	0	0	0	0	0	0	0	0	0	$+V_{REF}/2$
0	0	0	0	0	0	0	0	0	0	0	0	0	0	0	0	0
1	1	1	1	1	1	1	1	1	1	1	1	1	1	1	1	-1LSB
1	1	0	0	0	0	0	0	0	0	0	0	0	0	0	0	$-V_{REF}/2$
1	0	0	0	0	0	0	0	0	0	0	0	0	0	0	1	$-V_{REF} + 1LSB$
1	0	0	0	0	0	0	0	0	0	0	0	0	0	0	0	$-V_{REF} + 1LSB$

Note: V_{REF} = VRI input voltage
 $1LSB = V_{REF}/2^{15}$
 Code input of 1000 0000 0000 0000 will not make the output of $-V_{REF}$.



RECOMMENDED OPERATING CONDITIONS

Parameter	Symbol	Pin Name	Min	Typ	Max	Unit
Power Supply Voltage	V _{DD}	V _{DD}	4.75	5.00	5.25	V
	V _{SS}	V _{SS}	-5.25	-5.00	-4.75	V
Reference Voltage	V _{RI}	V _{RI}		2.5		V
Load Impedance	R _L	AO	20			kΩ
	C _L				20	pF
Ambient Operating Temperature	T _A		0		70	°C

DC CHARACTERISTICS

(DG = AG = 0V, V_{DD} = 5V ± 5%, V_{SS} = -5V ± 5%, f_{MCLK} = 800 kHz, V_{RI} = 2.5V, T_A = 0 to 70°C)

Parameter	Symbol	Pin Name	Condition	Min	Typ	Max	Unit
Power Supply Current	I _{DD}	V _{DD}				15	mA
	I _{SS}	V _{SS}		-15			mA
Power Supply Current at Power Down	I _{DDST}	V _{DD}				1	mA
	I _{SSST}	V _{SS}		-0.5			mA
Reference Voltage	V _{RO}	V _{RI}			2.5		V
Digital High-level Input Voltage	V _{IH}	*1		2		V _{DD}	V
Digital Low-level Input Voltage	V _{IL}			0		0.8	V
Digital High-level Output Voltage	V _{OH}	*2	I _{OH} = 0.1mA	4.0		V _{DD}	V
			I _{OH} = 1mA	2.4		V _{DD}	
Digital Low-level Output Voltage	V _{OL}	*3	I _{OL} = 2.4mA	0		0.4	V
Digital Input Leak Current	"L" Level	*3		-10		10	μA
	"H" Level			-10		10	
IRQ Leakage Current at OFF	I _{LIRQ}	IRQ		-10		10	μA
DB High-level Leakage Current at OFF	I _{LDBH}	DB ₀ to DB ₁₅	V _{OH} = V _{DD}	-10		10	μA
DB Low-level Leakage Current at OFF	I _{LDBL}		V _{OL} = 0V	-10		10	μA
Off-set Voltage	V _{OFF}	A _{IN} , A _O		-50		+50	mV
Linearity Error	LE				±0.02		%FSR
Differential Linearity Error	DLE				±0.02		%FSR

Note: *1: DB₀ to DB₁₅, DI, STB, MCLK, \overline{UDS} , \overline{LDS} , \overline{CS} , \overline{RD} , \overline{WR} , PD, MODE, \overline{RES}

*2: DB₀ to DB₁₅, DO

*3: DB₀ to DB₁₅, DO, \overline{IRQ}

AC CHARACTERISTICS

(DG = AG = 0V, V_{DD} = 5V ± 5%, V_{SS} = -5V ± 5%, f_{MCLK} = 800 kHz, V_{R1} = 2.5V, T_A = 0 to 70°C)

Parameter	Symbol	Pin Name	Condition	Min	Typ	Max	Unit	
Clock Frequency	f _{MCLK}	MCLK		10		800	kHz	
	f _{STB}	STB				2.5	MHz	
Clock Duty Ratio	D _{MCLK}	MCLK		45	50	55	%	
Sampling Rate	f _{SAMPLE}					50	kSPS	
Absolute Gain	G _A		1kHz, FS -20dB sine wave 50kSPS T _a = 25°C BW = 20kHz	V _{R1} = 2.5V	-0.1	0	+0.1	dB
			Connect to V _{R1} and V _{RO}	-0.5	0	+0.5		
Total Harmonic Distortion	T.H.D.		1kHz, sine wave 50kSPS T _a = 25°C PW = 20kHz	FS -20dB			-60	dB
				FS		-76		
Input Impedance (R _I /C _I)	R _I	A _{IN}	A/D mode during STRT = H		100		kΩ	
	C _I					50	100	pF

SWITCHING CHARACTERISTICS

(DG = AG = 0V, V_{DD} = 5V, V_{SS} = -5V, f_{MCLK} = 720kHz, V_{RI} = 2.5V, T_A = 25°C)

Parameter	Fig.	Symbol	Min	Max	Unit
Data Write Pulse Width	1	t _{WT}	200		ns
Data Setup Time for Data Write	1	t _{SBW}	200		ns
Data Hold Time for Data Write	1	t _{HBW}	50		ns
Data Write Interval	1	t _{IW}	200		ns
Data Non-Write $\overline{\text{LDS}}/\overline{\text{UDS}}$ Setup Time	1	t _{SDW}	50		ns
Data Non-Write $\overline{\text{LDS}}/\overline{\text{UDS}}$ Hold Time	1	t _{HDW}	50		ns
Write Command Pulse Width	1	t _{WW}	200		ns
Write Command Hold Time for First Conversion Cycle	2	t _{HWN}	0		ns
Write Command Setup Time Preventing from Conversion Start	2	t _{SWI}	100		ns
Write Command Hold Time Not to Start Conversion	2	t _{HWP}	100		ns
Write Command Hold Time for Conversion Start	2	t _{SWP}	100		ns
$\overline{\text{WR}}$ Setup Time for Data Read (D/A mode only)	3	t _{SWC}	50		ns
$\overline{\text{WR}}$ Hold Time for Data Read (D/A mode only)	3	t _{HWC}	50		ns
Data Read Pulse Width	3	t _{WR}	200		ns
Delay Time to Valid Data Output	3	t _{EB}	0	200	ns
Disappearance Time for Valid Data	3	t _{DB}	0		ns
$\overline{\text{RD}}$ Hold Time for Last Conversion Cycle	4/5	t _{HRK}	0		ns
$\overline{\text{RD}}$ Setup Time for Last Conversion Cycle	4/5	t _{SRK}	0		ns
$\overline{\text{LDS}}/\overline{\text{UDS}}$ Setup Time for Serial Data Transfer Start	5	t _{SDR}	50		ns
$\overline{\text{LDS}}/\overline{\text{UDS}}$ Hold Time for Serial Data Transfer Completion	5	t _{HDR}	50		ns
STB Setup Time for Read Command	5	t _{STR}	100		ns
STB Hold Time for Read Command	5	t _{HTR}	100		ns
High-Level STB Pulse Width	5	t _{WSH}	200		ns
Low-Level STB Pulse Width	5	t _{WSL}	200		ns

(DG = AG = 0V, V_{DD} = 5V, V_{SS} = -5V, f_{MCLK} = 720kHz, V_{RI} = 2.5V, T_A = 25°C)

Parameter	Fig.	Symbol	Min	Max	Unit
MSB Output Delay Time	5	t _{DOK}	0	500	ns
Serial Output Delay Time	5	t _{DOT}	0	150	ns
MSB Input Setup Time	5	t _{SIR}	50		ns
MSB Input Hold Time	5	t _{HIR}	50		ns
Serial Input Setup Time	5	t _{SIT}	50		ns
Serial Input Hold Time	5	t _{HIT}	50		ns
STRT Output Delay Time	6	t _{DSK}	0	300	ns
Analog Input Setup Time	6	t _{SA}	1.2		μs
Analog Input Hold Time	6	t _{HA}	0		ns
Command Setup Time for $\overline{\text{IRQ}}$ = Low	6	t _{SCK}	200		ns
$\overline{\text{IRQ}}$ Falling Delay Time	6	t _{DIK}	0	200	ns
$\overline{\text{IRQ}}$ Rising Delay Time (Pull-up Resistance = 5kΩ, C _L = 10pF)	6	t _{DIC}	0	200	ns
Analog Output Settling Time	6	t _{DA}	0	8	μs
Valid Output Hold Time	6	t _{AE}		500	μs
$\overline{\text{CS}}$ Setup Time for Reset Completion	7	t _{SRES}	500		ns
$\overline{\text{CS}}$ Hold Time for Reset Completion	7	t _{HRES}	20		clock cycle
Reset Pulse Width	7	t _{WRES}	500		ns
PD Setup Time	8	t _{SPK}	100		ns
PD Hold Time	8	t _{HPK}	500		ns
MODE Setup Time	8	t _{SMK}	100		ns
MODE Hold Time	8	t _{HMK}	500		ns
Power Down Time from Conversion Completion	9	t _{PDK}		1	ms
Power Down Time from PD	9	t _{PDP}		1	ms
Power Up Time	9	t _{PUP}		10	ms



TIMING DIAGRAM PARALLE TRANSMISSION

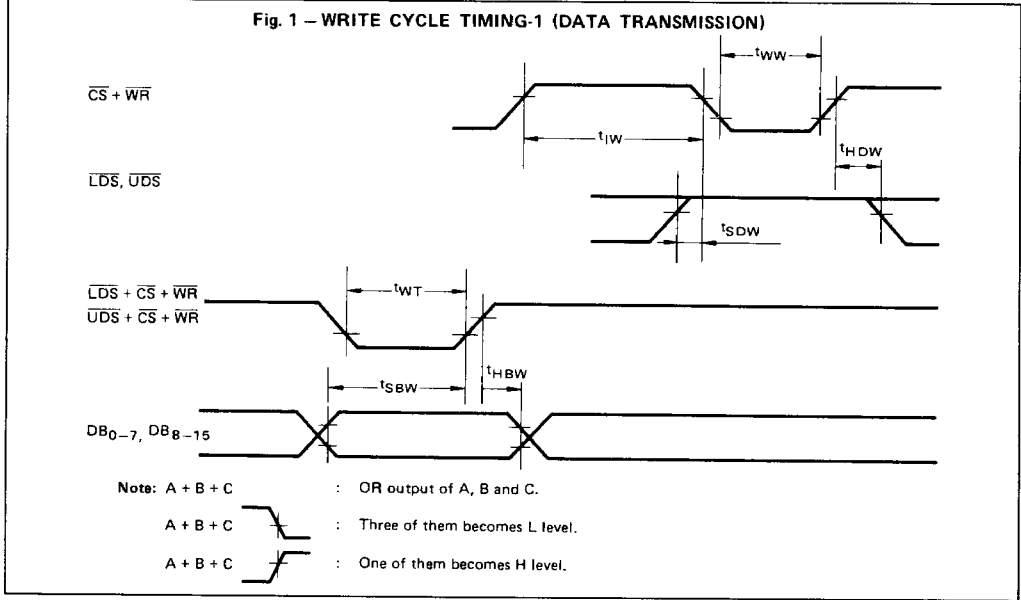

7

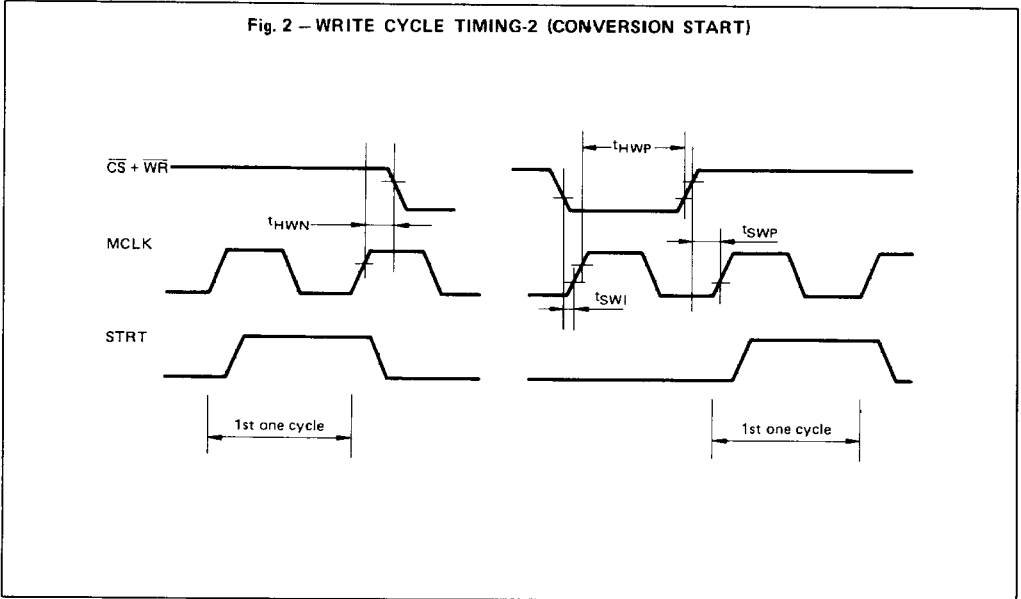

PARALLEL TRANSMISSION

Fig. 3 – READ CYCLE TIMING-1 (DATA TRANSMISSION)

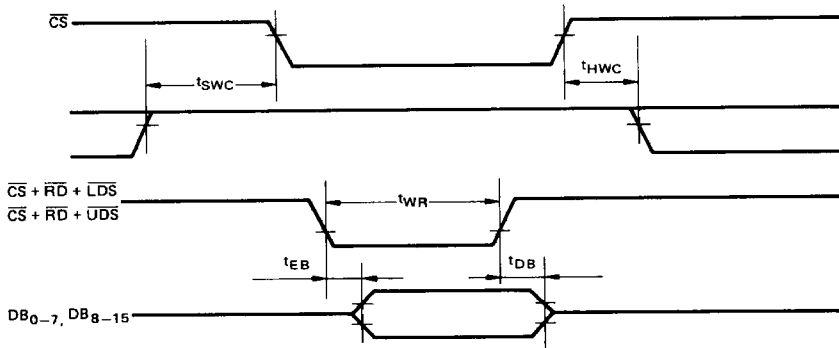

7

Fig. 4 – READ CYCLE TIMING-2 (CONVERSION START)

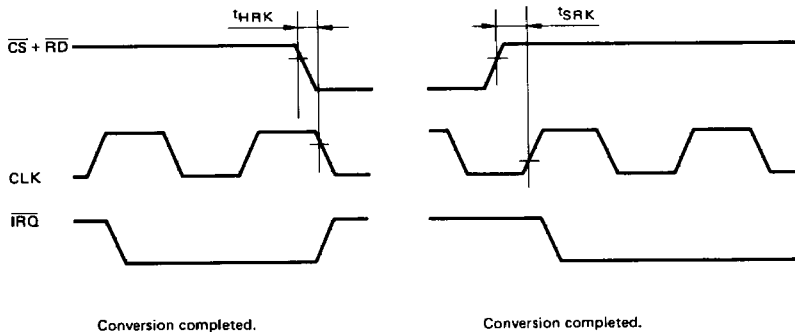

Note: Except for serial transmission mode, t_{HRK} , t_{SRK} specification is necessary to read out normally. Unless these spec are specified, the data will not destroy.

TIMING DIAGRAM (continued)
SERIAL TRANSMISSION

Fig. 5 - SERIAL INPUT/OUTPUT

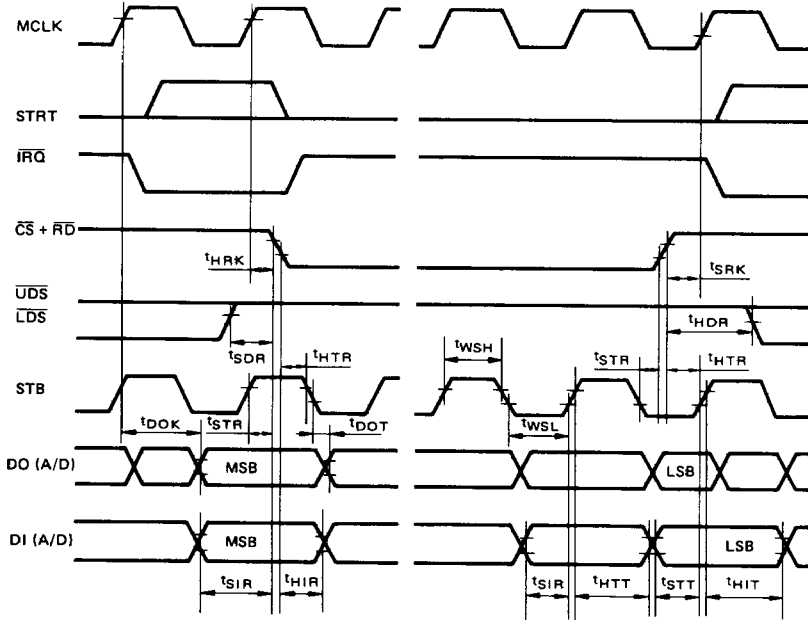

7

OTHER TIMING

Fig. 6 – STRT, IRQ, AIN, PO TIMING

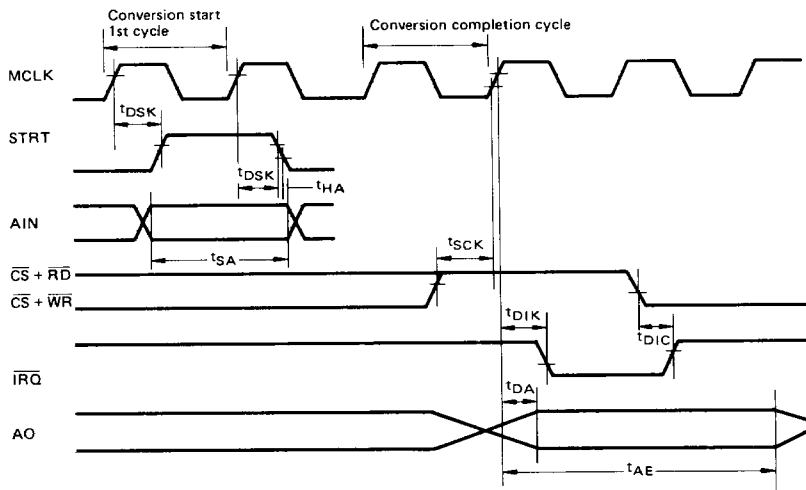

Note: t_{SCK} is necessary condition that $\overline{\text{IRQ}}$ becomes L. However, if this condition is not satisfy, operation has no effect.



TIMMING DIAGRAM (continued)

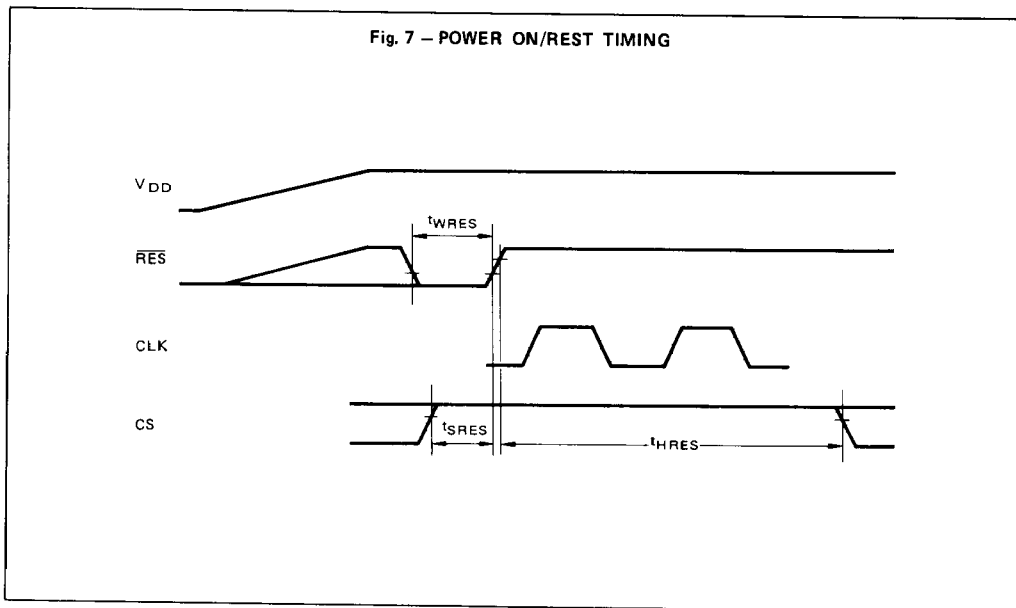

7

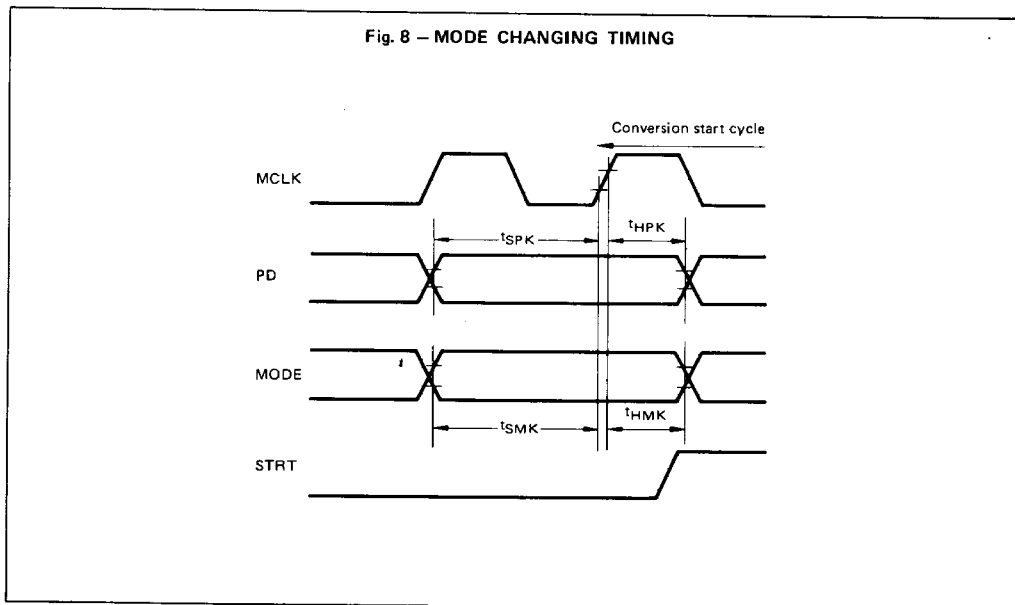
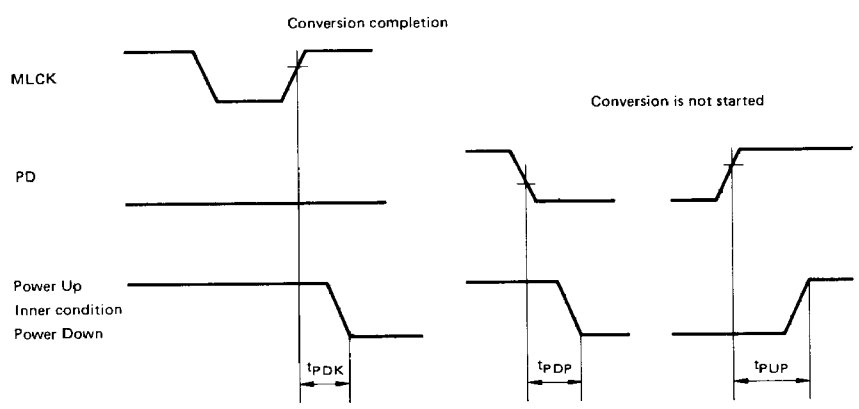
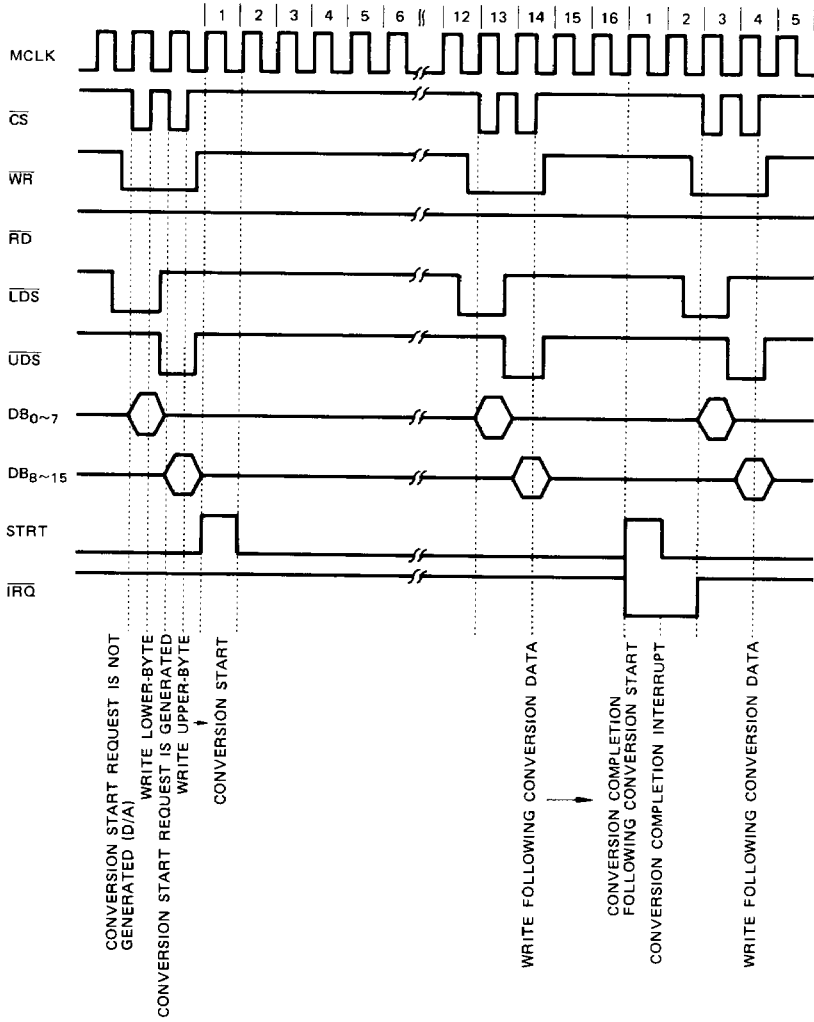

Fig. 9 – POWER DOWN TIMING



OPERATING TIMING

Fig. 10 – D/A, 8-BIT MICROPROCESSOR



7

Fig. 11 – A/D 16BIT MICRO PROSESSOR

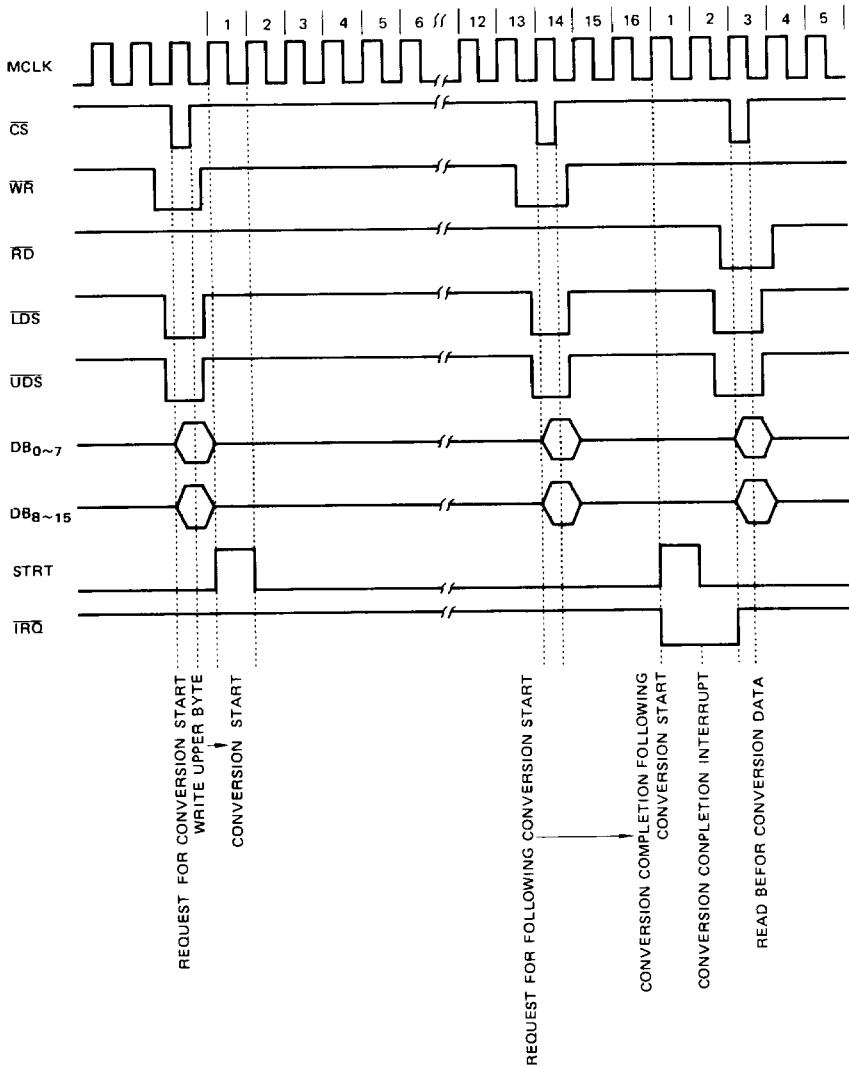
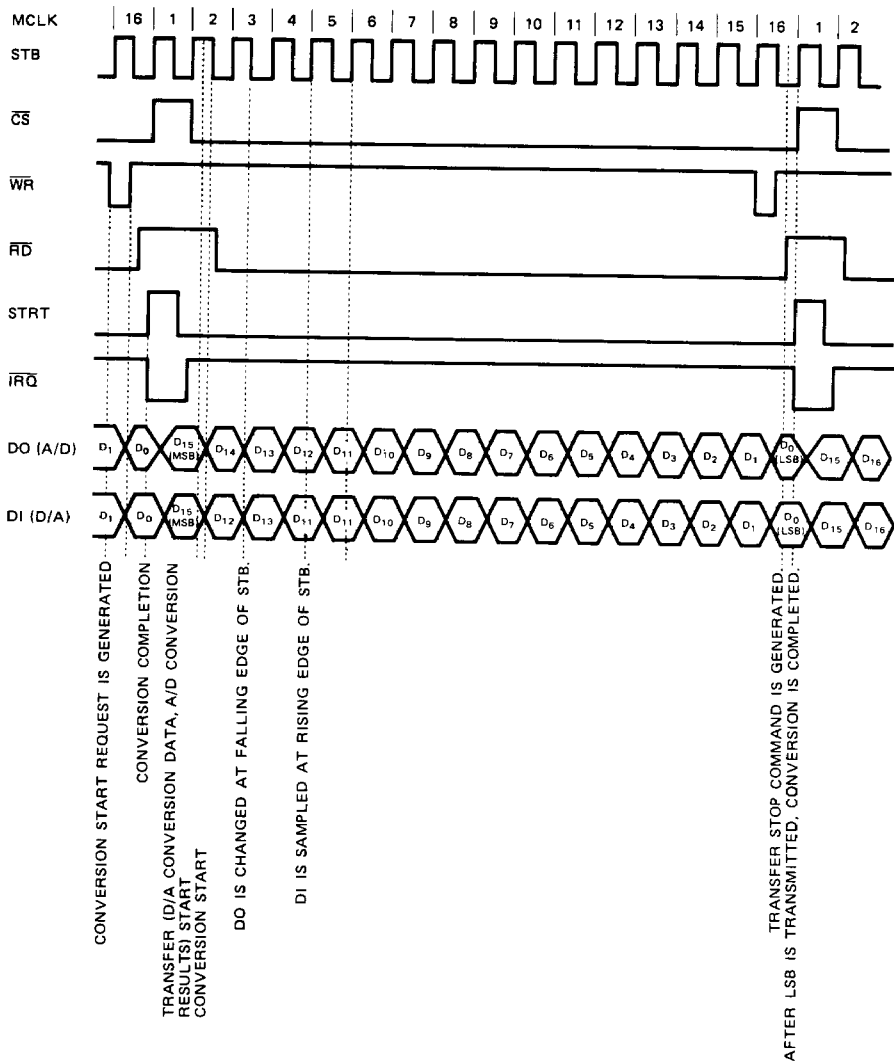
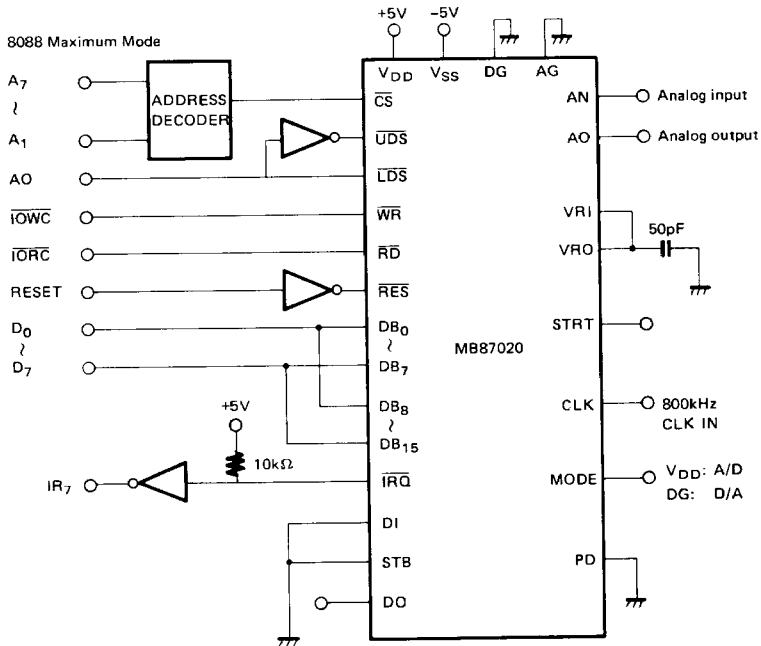

Fig. 12 - A/D, SERIAL OUTPUT OR D/A, SERIAL INPUT



INTERFACE CIRCUIT EXAMPLE

Fig. 13 – INTERFACE WITH 8088 MAXIMUM MODE



Note: When \overline{LDS} is low, even byte is stored in lower I/O register.
 When \overline{UDS} is low, odd byte is stored in high I/O register.
 Interruption is used as the high priority.
 Conversion range is between -2.5V and +2.5V.
 The data stored in AX register are D/A converted by OUT command.

INTERFACE EXAMPLE WITH VARIOUS INTERFACE

Object		Control Signal	Example of main input control pin of MB87020						
			DB ₀ to DB ₇	DB ₈ to DB ₁₅	\overline{CS}	\overline{WR}	\overline{RD}	\overline{UDS}	\overline{LDS}
MP	Z80 (80 series 8-bit CPU)	\overline{WR} , \overline{RD} , D ₀ to D ₇ , A ₀ to A ₁₅	D ₀ to D ₇	D ₀ to D ₇	Address decoder output	\overline{WR}	\overline{RD}	Inverted output of A	AO
	6800 (68 series 16-bit CPU)	R/\overline{W} , VMA, ϕ_2 , D ₀ to D ₇ , A ₀ to A ₁₅	D ₀ to D ₇	D ₀ to D ₇	***	R/\overline{W}	Inverted output of R/\overline{W}	Inverted output of A	AO
	8086 (86 series 16-bit CPU)	\overline{MWTC} , \overline{MRDC} , D ₀ to D ₁₅ , A ₀ to A ₁₉	D ₀ to D ₇	D ₈ to D ₁₅	Address decoder output	\overline{MWTC}	\overline{MRDC}	\overline{BHE}	AO
	68000 (68000 series 16-bit CPU)	R/\overline{W} , AS, \overline{LDS} , \overline{UDS} , A ₀ to A ₂₃	D ₀ to D ₇	D ₈ to D ₁₅	****	R/\overline{W}	Inverted output of R/\overline{W}	\overline{UDS}	\overline{LDS}
D/A conversion only, D ₀ to D ₁₅ (Parallel data), Conversion start request signal ST (Low active)			D ₀ to D ₇	D ₈ to D ₁₅	L	\overline{ST}	H	L	L
A/D conversion only, Conversion start request signal ST (Low active) D ₀ to D ₁₅ (Parallel data request)			D ₀ to D ₇	D ₈ to D ₁₅	L	\overline{ST}	L	L	L
A/D or D/A serial conversion transmission BUSY (Low active) Conversion start request signal ST (Low active)			L or H	L or H	L	\overline{ST}	\overline{BUSY}	H	H
MB87064 (Fujitsu 16-bit DSP)	\overline{BCT} , \overline{ACT} , D ₀ to D ₁₅		D ₀ to D ₇	D ₈ to D ₁₅	L	\overline{BCT}	\overline{ACT}	L	L

*** Address decoder output after VMA, ϕ_2 gate

**** Address decoder output after AS gate

TEST CIRCUIT

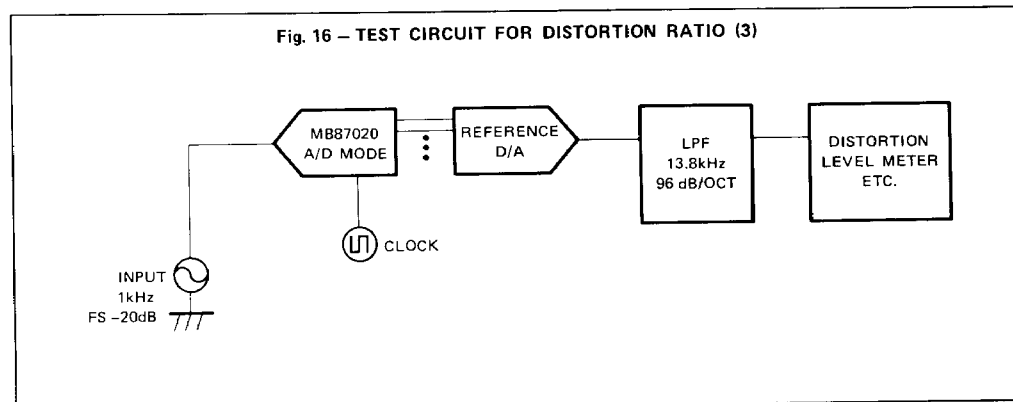
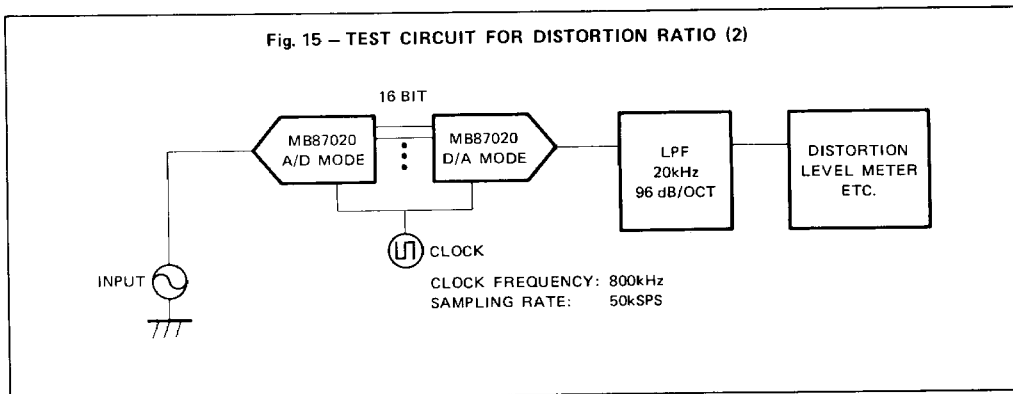
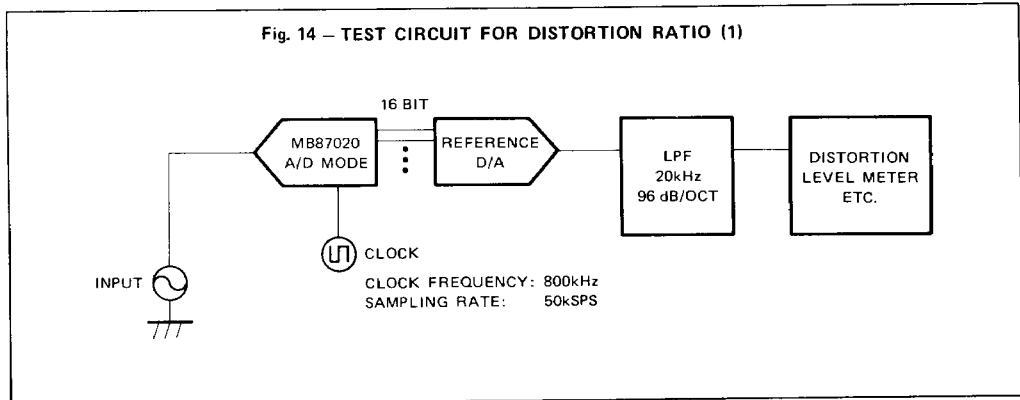

TEST CIRCUIT (continued)

Fig. 17 – TEST CIRCUIT FOR DISTORTION RATIO (4)

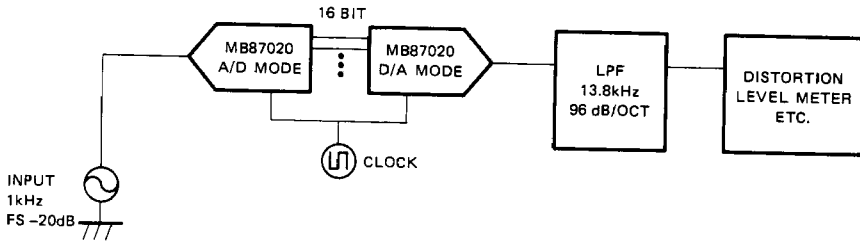

7

Fig. 18 – TEST CIRCUIT FOR ABSOLUTE GAIN

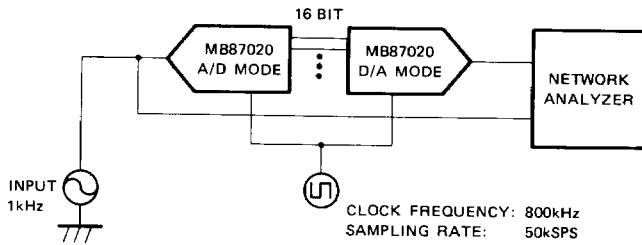
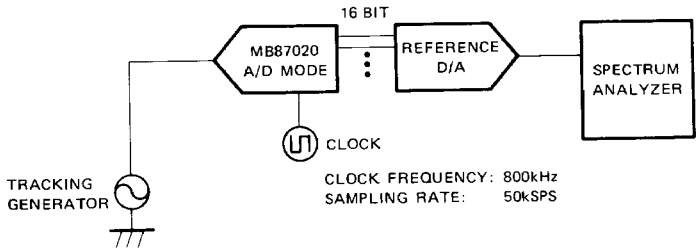

Fig. 19 – TEST CIRCUIT FOR FREQUENCY CHARACTERISTICS (1)



7

Fig. 20 – TEST CIRCUIT FOR FREQUENCY CHARACTERISTICS (2)

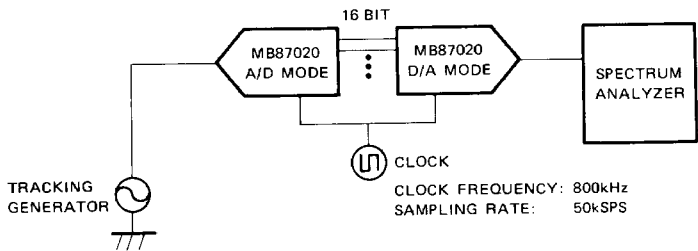

Fig. 21 – SIGNAL LEVEL OF ADC MODE vs. DISTORTION RATIO

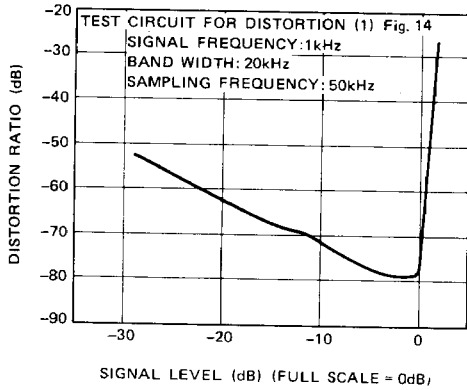

Fig. 22 – SIGNAL LEVEL OF DAC MODE vs. DISTORTION RATIO

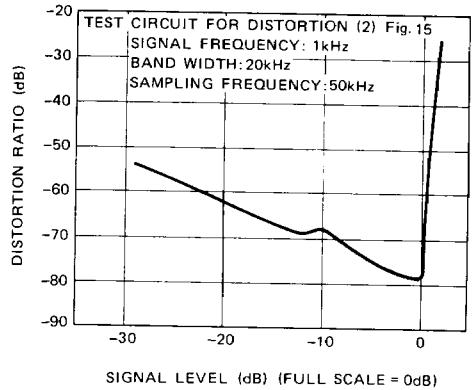

Fig. 23 – SIGNAL FREQUENCY vs. DISTORTION RATIO

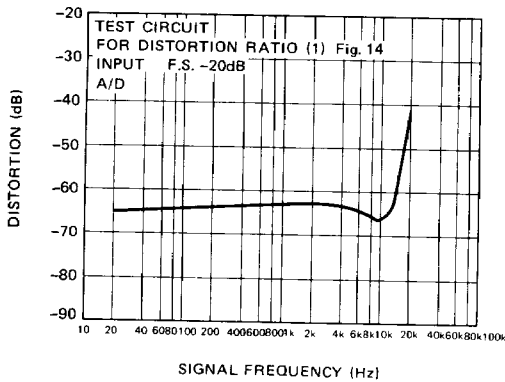

Fig. 24 – SIGNAL FREQUENCY vs. DISTORTION

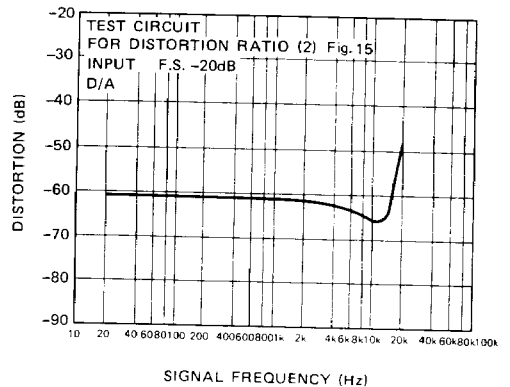

Fig. 25 – TEMPERATURE vs. DISTORTION RATIO (A/D MODE)

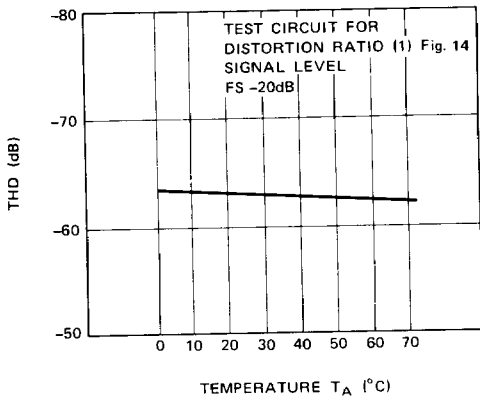
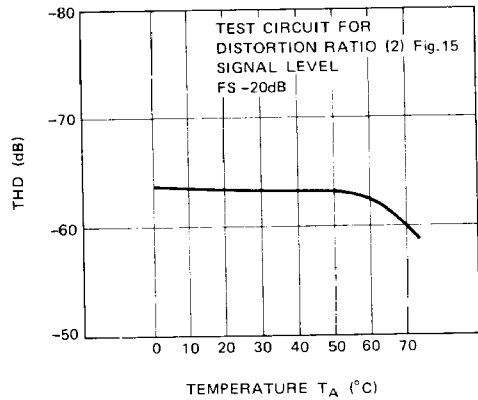

Fig. 26 – TEMPERATURE vs. DISTORTION RATIO (D/A MODE)



7

Fig. 27 – SAMPLING FREQUENCY vs. DISTORTION RATIO

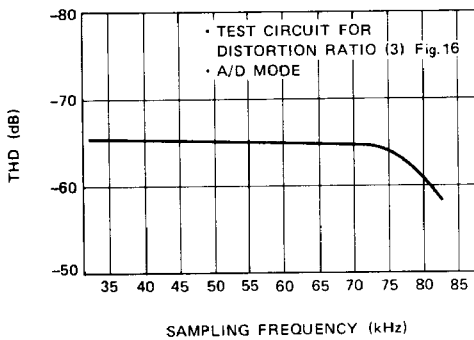

Fig. 28 – SAMPLING FREQUENCY vs. DISTORTION RATIO

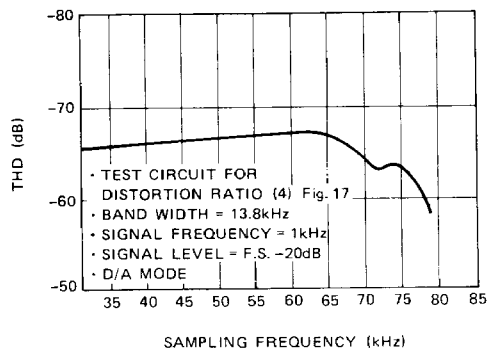



Fig. 29 – INPUT LEVEL vs. GAIN

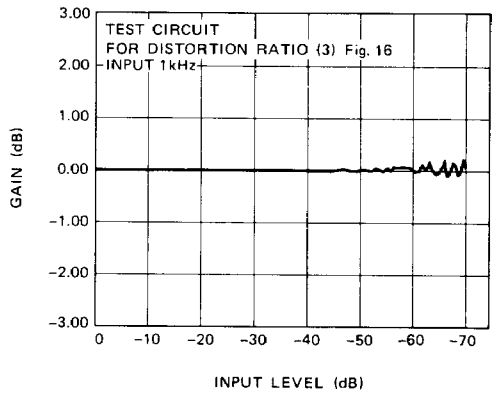

Fig. 30 – SIGNAL FREQUENCY vs. GAIN

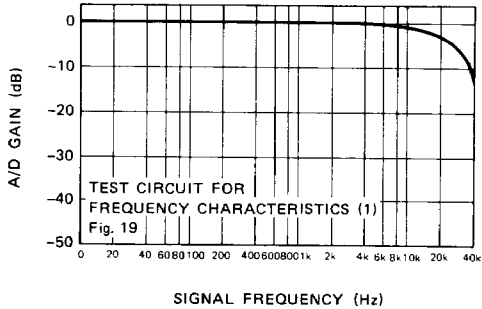
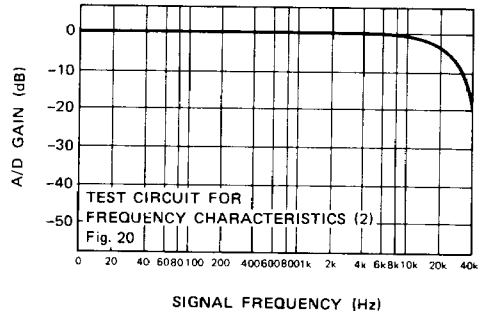

Fig.31 – SIGNAL FREQUENCY vs. GAIN



PACKAGE DIMENSIONS

