

ASSP for Screen Display Control

CMOS

ON-Screen Display Controller (OSDC-360)

MB90092

■ DESCRIPTION

The MB90092 is the display controller for displaying text and graphics on the TV screen.

The MB90092 incorporates display memory (VRAM), a font memory interface, and a video signal generator, allowing text and graphics to be displayed in conjunction with a small number of external components.

The MB90092 can provide two screens, called the main screen and the sub-screen, either independently or overlaid one on top of the other.

The main screen consists of 24 characters by 12 lines and allows data to be set for each character. The sub-screen consists of 24 characters by 12 lines or up to 32 characters by 16 lines. Data can be set either for each line in the former configuration or collectively for the entire screen in the latter configuration.

The characters supported by the MB90092 are the normal characters made up of 24 by 32 dots and the 8 × 32-dot graphic characters that can be displayed in any of eight different colors in character units.

If filled with only graphic characters, the main screen is 192 (horizontal) × 384 (vertical) dots. In the same case, the sub-screen is 192 (horizontal) × 384 (vertical) dots, or 256 (horizontal) × 512 (vertical) dots. (The actual display screen depends on the dot clock frequency in the horizontal direction and on the number of rasters of the television system in the vertical direction.) The MB90092 uses RAM as font memory, enabling free graphics display. The MB90092 can use up to 16384 types of characters including normal and graphic characters in total. It can control up to 16M bits of external font memory.

For output of video signals, the MB90092 has the composite video signal, Y/C-separated video signal, and RGB digital output pins. The MB90092 also has video signal input pins, allowing superimpose display over either composite video signals and Y/C-separated video signals.

■ PACKAGE

80-pin Plastic QFP

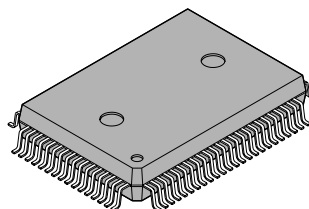

(FPT-80P-M06)

■ FEATURES

Main Screen Display

- Screen display capacity: 24 characters × 12 lines (up to 288 characters)
- Character sizes: Standard, double width, double height, double width × double height, quadruple width × double height (Setting possible for each line)
- Display position control: Horizontal display start position: Set in 1/3-character units
Vertical display start position: Set in raster units
Line spacing control: Set in raster units (0 to 15 rasters)
- Display priority control: Capable of controlling display priority over the sub-screen (for each line)

• Normal mode display

- Normal character exclusive display mode:
Screen capacity: 24 characters × 12 lines (up to 288 characters)
Character types: 8192 different characters (8 M addresses)
- Character display: Character dot configuration: 24 × 32 dots (per character)
Character color: 8 colors (for each character) × 4 phases (for each line)
Character background color: 8 colors (for each character)
Display mode: Selectable from among the pattern background/
solid-fill background/no background modes

• Extended graphics mode display

- Mode for displaying individually selected, normal and graphic characters mixed:
Screen capacity: 24 characters × 12 lines (up to 288 characters)
192 horizontal dots × 384 vertical dots (entire screen)
Character types: 16384 different characters (16 M addresses)
- Normal character display: Character dot configuration: 24 horizontal dots × 32 vertical dots
Character color: 8 colors (for each character) × 4 phases (for each line)
Line background color: 8 colors (for each line)
Display mode: Selectable from among the pattern background/
solid-fill background/no background modes
Shaded background display available (set for each character)
- Graphic character display: Character dot configuration: 8 horizontal dots × 32 vertical dots
Character color: 8 colors (for each dot) × 4 phases (for each character)

Sub-Screen Display

Screen display position: Settable horizontally and vertically in 2-dot units

• Normal screen mode

- Normal character display: Screen capacity: 32 characters × 12 lines (up to 384 characters)
256 horizontal dots × 384 vertical dots (graphics characters only) (The actual display screen depends on the television system and dot clock frequency.
Normal character/graphic character display selectable for each line (Header display character code is specified for each line.)
Character string length: Selectable from among 1, 2, 4, 8, 16, 24, and 32 digits
- Normal character display: Character dot configuration: 24 horizontal dots × 32 vertical dots
Character color: 8 colors (for each line)
Pattern background color: 8 colors (entire screen)
- Graphic character display: Character dot configuration: 8 horizontal dots × 32 vertical dots
Character color: 8 colors (for each dot) × 4 phases (for each line)

- **Full-screen mode**

- | | |
|--------------------------|---|
| Screen capacity: | 32 characters × 16 lines (up to 512 characters)
256 horizontal dots × 512 vertical dots
(The actual display screen depends on the television system and dot clock frequency.) |
| Virtual screen capacity: | Mode A: 32 characters × 16 lines (× 32 screens)
256 horizontal dots × 512 vertical dots
Mode B: 512 characters × 32 lines
4096 horizontal dots × 1024 vertical dots |
- Normal character display: Character dot configuration: 24 horizontal dots × 32 vertical dots
Character color: 8 colors (set for the entire screen)
Pattern background color: 8 colors (set for the entire screen)
 - Graphic character display: Character dot configuration: 8 horizontal dots × 32 vertical dots
Character color: 8 colors (for each dot) × 4 phases (set for the entire screen)

Screen Background Display

Screen background color: 8 colors (set for the entire screen)

Analog Inputs

- Composite video signal input
- Y/C-separated inputs

Analog Outputs

- Composite video signal output
- Y/C-separated outputs

Digital Outputs

- G (Green), R (Red), and B (Blue) output
- VOC (character) output, VOB (character + background) output
- Characters, character background, line background, and screen background each capable of being displayed in eight colors

Internal Synchronization Control (Video Signal Generator)

- Internal video signal generator supporting the NTSC and PAL systems
- Interlaced/noninterlaced display selectable

External Synchronization Control

- Separated sync signal input/composite sync signal input selectable

External Interface

- 8-bit serial inputs (3 signal input pins)
Chip select: \overline{CS}
Serial clock: SCLK
Serial data: SIN

Package

- QFP-80

Miscellaneous

- Internal power-on reset circuit

MB90092

■ PIN ASSIGNMENT

Figure 1 shows the pin assignment of the MB90092.

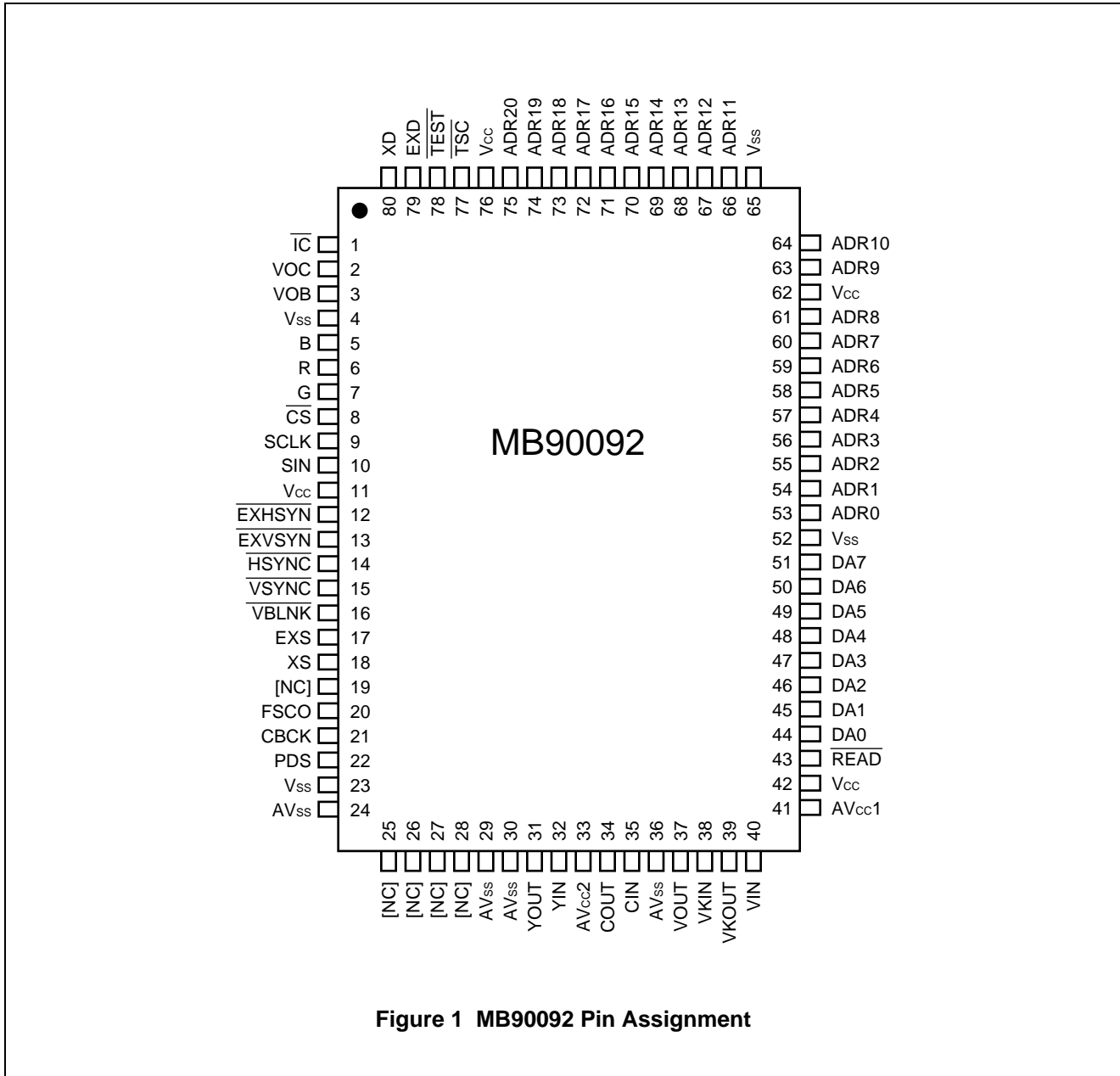

■ PIN DESCRIPTIONS

Pin name	Pin no.	I/O	Function
\overline{IC}	1	I	Internal color generation mode setting pin This pin outputs the internally generated color burst signal to the video signal output in response to Low-level input during external synchronization control operation. The pin can also be used as a reset signal input pin by Low-level input to the \overline{TEST} pin. In this case, Low-level input to this pin resets the MB90092. The pin is a hysteresis input with an internal pull-up resistor.
VOC	2	O	Character interval signal output pin The output signal represents the character dot output interval.
VOB	3	O	Character/background internal signal output pin During internal synchronization control operation, the output signal represents the character, character background, line background, or screen background output interval.
B	5	O	Color signal output pins
R	6	O	These pins output the character, character background, line background, and screen background color signals.
G	7	O	
\overline{CS}	8	I	Chip select pin For serial transfer, set this pin to the Low level. This pin is also used to release a power-on reset. The pin is a hysteresis input with an internal pull-up resistor.
SCLK	9	I	Shift clock input pin for serial transfer This pin is a hysteresis input with an internal pull-up resistor.
SIN	10	I	Serial data input pin The pin is a hysteresis input with an internal pull-up resistor.
\overline{EXHSYN}	12	I	External horizontal sync signal input pin This pin can also serve as a composite sync signal input pin depending on the internal register setting. The pin is a hysteresis input with an internal pull-up resistor.
\overline{EXVSYN}	13	I	External vertical sync signal input pin Input to this pin is disabled when composite sync signal input has been selected by setting the internal register.
\overline{HSYNC}	14	O	Horizontal sync signal output pin This pin can also output composite sync signals depending on the internal register setting. The pin outputs the signal (FSC) resulting from dividing the 4FSC clock frequency by setting the \overline{TEST} pin to the Low level.
\overline{VSYNC}	15	O	Vertical sync signal output pin This pin is fixed at the High level when composite sync signal output has been selected by setting the internal register. The pin outputs the dot clock oscillator signal when the \overline{TEST} pin goes Low.

(Continued)

MB90092

Pin name	Pin no.	I/O	Function
$\overline{\text{VBLNK}}$	16	O	Vertical blanking interval signal output pin This pin outputs the Low-level signal in the vertical blanking interval.
EXS XS	17 18	I O	External circuit pins for color burst clock generator Connect an external crystal oscillator (14.31818 MHz for NTSC or 17.734475 MHz for PAL) and load capacitance (C) to these pins to form a crystal oscillator circuit.
FSCO	20	O	Internal color burst clock output pin This pin controls internal color burst clock output depending on the FO bit of command 7.
CBCK	21	I	External color burst clock input pin
PDS	22	O	Pin for output of the result of color burst clock phase comparison
YOUT	31	O	Luminance signal output pin This pin outputs a signal of 2 V _{P-P} (pedestal level 1.57 V, sink chip level 1 V).
YIN	32	I	Luminance signal input pin for superimpose display This pin inputs a DC-reproduced (DC-clamped) signal of 2 V _{P-P} (pedestal level 1.57 V, sink chip level 1 V).
COUT	34	O	Saturation signal output pin This pin outputs a signal at 1.57 VDC and a color burst signal amplitude of 0.57 V _{P-P} .
CIN	35	I	Saturation signal input pin for superimpose display This pin inputs a signal at 1.57 VDC and a color burst signal amplitude of 0.57 V _{P-P} .
VOUT	37	O	Composite video signal output pin This pin outputs a signal of 2 V _{P-P} (pedestal level 1.57 V, sink chip level 1 V).
VKIN	38	I	Background level control input pin for halftone background display of external input composite video signals (input to the VIN pin and output from the VOUT pin) Halftone background display is controlled by setting the KID bit of command 5 to "1".
VKOUT	39	O	Background level control output pin for halftone background display of external input composite video signals (input to the VIN pin and output from the VOUT pin) Halftone background display is controlled by setting the KID bit of command 5 to "1".
VIN	40	I	Composite video signal input pin for superimpose display This pin inputs a DC-reproduced (DC-clamped) signal of 2 V _{P-P} (pedestal level 1.57 V, sink chip level 1 V).

(Continued)

Pin name	Pin no.	I/O	Function
$\overline{\text{READ}}$	43	O	External font memory read control pin This pin outputs the Low-level signal in the font memory read period. The pin enters the high impedance state when the $\overline{\text{TSC}}$ pin inputs a Low-level signal.
DA0 DA1 DA2 DA3 DA4 DA5 DA6 DA7	44 45 46 47 48 49 50 51	I I I I I I I	External font memory data input pins These pins are TTL level inputs with an internal pull-up resistor.
ADR0 ADR1 ADR2 ADR3 ADR4 ADR5 ADR6 ADR7 ADR8 ADR9 ADR10 ADR11 ADR12 ADR13 ADR14 ADR15 ADR16 ADR17 ADR18 ADR19 ADR20	53 54 55 56 57 58 59 60 61 63 64 66 67 68 69 70 71 72 73 74 75	O	External font memory address output pins These pins enter the high impedance state when the $\overline{\text{TSC}}$ pin inputs a Low-level signal. <div style="display: flex; align-items: center;"> <div style="margin-right: 10px;"> <p>ADR0 ADR1 ADR2 ADR3 ADR4</p> <p>ADR5 — M0, SM0 ADR6 — M1, SM1 ADR7 — M2, SM2 ADR8 — M3, SM3 ADR9 — M4, SM4 ADR10 — M5, SM5 ADR11 — M6, SM6</p> <p>ADR12 — Data distinction bits (12,13 = 00: Left, 10: Center, 01: Right)</p> <p>ADR14 — M7, SM7 ADR15 — M8, SM8 ADR16 — M9, SM9 ADR17 — MA, SMA ADR18 — MB, SMB ADR19 — MC, SMC ADR20 — MD, SMD</p> </div> <div style="margin-left: 10px;"> <p>Raster address</p> <p>Character code (Lower bits)</p> <p>Character code (Higher bits)</p> </div> </div>
$\overline{\text{TSC}}$	77	I	Tristate control input pin for external font memory control bus When this pin inputs a Low-level signal, the ADR0 to ADR20 pins and the $\overline{\text{READ}}$ pin enter the high impedance state. The pin is a hysteresis input with an internal pull-up resistor.
$\overline{\text{TEST}}$	78	I	Test signal input pin This pin usually inputs a High-level (fixed) signal.
EXD XD	79 80	I O	External circuit pins for display dot clock generator Connect these pins to external "L" and "C" to form an LC oscillator circuit.

(Continued)

MB90092

(Continued)

Pin name	Pin no.	I/O	Function
[N.C]	19 25 26 27 28	— — — — —	Leave these pins unconnected.
V _{cc}	11 42 62 76	— — — —	Power-supply pins (+5 V)
V _{ss}	4 23 52 65	— — — —	Ground pins
AV _{cc1}	41	—	Analog power pin for composite video signals (VIN-VOUT)
AV _{cc2}	33	—	Analog power pin for luminance (YIN-YOUT) and chroma (CIN-COUT) signals
AV _{ss}	24 29 30 36	— — — —	Analog circuit ground pins Set these pins to the same level as the V _{ss} pin.

■ BLOCK DIAGRAM

Figure 2 is a block diagram of the MB90092.

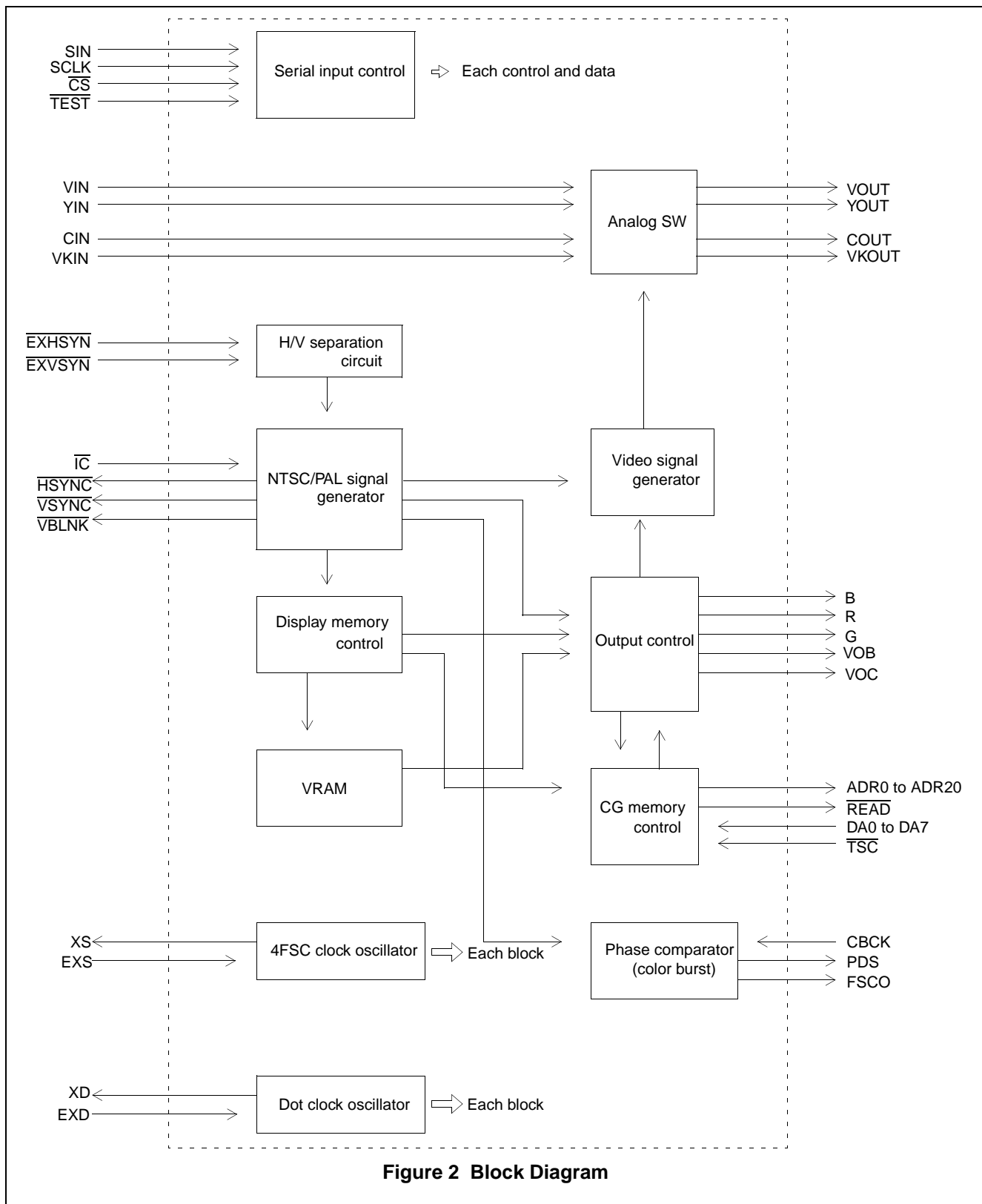

■ ABSOLUTE MAXIMUM RATINGS

Parameter	Symbol	Value		Unit	Remarks
		Min.	Max.		
Supply voltage	V _{CC}	V _{SS} – 0.3	V _{SS} + 7.0	V	*1
	AV _{CC1}	V _{SS} – 0.3	V _{SS} + 7.0	V	*1
	AV _{CC2}	V _{SS} – 0.3	V _{SS} + 7.0	V	*1
Input voltage	V _{IN}	V _{SS} – 0.3	V _{SS} + 7.0	V	*2
Output voltage	V _{OUT}	V _{SS} – 0.3	V _{SS} + 7.0	V	*2
Power consumption	P _d	—	600	mW	
Operating temperature	T _a	–40	+85	°C	
Storage temperature	T _{stg}	–55	+150	°C	

*1: AV_{SS} and V_{SS} must have equal potential.

*2: Neither V_{IN} nor V_{OUT} must exceed “V_{CC} + 0.3 V.”

WARNING: Semiconductor devices can be permanently damaged by application of stress (voltage, current, temperature, etc.) in excess of absolute maximum ratings. Do not exceed these ratings.

■ RECOMMENDED OPERATING CONDITIONS

(V_{SS} = AV_{SS} = 0 V)

Parameter	Symbol	Value		Unit	Remarks
		Min.	Max.		
Supply voltage	V _{CC}	4.5	5.5	V	Specification guarantee range
	AV _{CC1}	4.5	5.5	V	*1, *2
	AV _{CC2}	4.5	5.5	V	*1, *3
“H” level input voltage	V _{IHS1}	2.2	V _{CC} + 0.3	V	DA0 to DA7
	V _{IHS2}	0.8 × V _{CC}	V _{CC} + 0.3	V	Except DA0 to DA7
“L” level input voltage	V _{ILS1}	–0.3	0.8	V	DA0 to DA7
	V _{ILS2}	–0.3	0.2 × V _{CC}	V	Except DA0 to DA7
Operating temperature	T _a	–40	+85	°C	
Analog input voltage	AV _{IN}	0	V _{CC}	V	

*1: AV_{SS} and V_{SS} must have equal potential.

*2: “AV_{CC1} = AV_{SS}” is allowed if composite video signals (V_{IN}-V_{OUT} pins) are not used.

*3: “AV_{CC2} = AV_{SS}” is allowed if Y/C-separated video signals (Y_{IN}-Y_{OUT} and C_{IN}-C_{OUT} pins) are not used.

WARNING: Recommended operating conditions are normal operating ranges for the semiconductor device. All the device’s electrical characteristics are warranted when operated within these ranges.

Always use semiconductor devices within the recommended operating conditions. Operation outside these ranges may adversely affect reliability and could result in device failure.

No warranty is made with respect to uses, operating conditions, or combinations not represented on the data sheet. Users considering application outside the listed conditions are advised to contact their FUJITSU representative beforehand.

■ ELECTRICAL CHARACTERISTICS

1. DC Characteristics

($T_a = -40^\circ\text{C}$ to $+85^\circ\text{C}$, $V_{SS} = AV_{SS} = 0\text{ V}$)

Parameter	Symbol	Pin	Conditions	Values			Unit	Remarks
				Min.	Typ.	Max.		
"H" level output voltage	V_{OH}	VOC VOB B R G	$V_{CC} = 4.5\text{ V}$ $I_{OH} = -2\text{ mA}$	4.0	—	—	V	
"L" level output voltage	V_{OL}	<u>HSYNC</u> <u>VSYNC</u> VBLNK FSCO READ ADR0 to ADR20	$V_{CC} = 4.5\text{ V}$ $I_{OL} = 4.0\text{ mA}$	—	—	0.4	V	
Input current	I_{IL}	<u>IC</u> <u>CS</u> SCLK SIN <u>EXHSYN</u> <u>EXVSYN</u> CBCK DA0 to DA7 <u>TSC</u> <u>TEST</u>	$V_{CC} = 5.5\text{ V}$ $V_{IL} = 0.0\text{ V}$	-200	—	-50	μA	
Supply current	I_{CC}	V_{CC} AV_{CC1} AV_{CC2}	$V_{CC} = AV_{CC1} = AV_{CC2} = 5.5\text{ V}$ $4f_{sc} = 17.734475\text{ MHz}$ $f_{DC} = 16.0\text{ MHz}$ No load	—	—	50	mA	
Analog supply current	I_A	AV_{CC1} AV_{CC2}	$V_{CC} = AV_{CC1} = AV_{CC2} = 5.5\text{ V}$ $4f_{sc} = f_{DC} = 0\text{ MHz}$ $AV_{IN} = 1.65\text{ V}$ No load	—	—	30	mA	
ON resistance	R_{ON}	VIN-VOUT YIN-YOUT CIN-COUT VIN-VKOUT VKIN-VOUT	$V_{CC} = AV_{CC1} = AV_{CC2} = 4.5\text{ V}$ $I_{OL} = 100\text{ }\mu\text{A}$	—	100	320	Ω	
Off leakage current	I_{OFF}	VIN YIN CIN VKIN	$V_{CC} = AV_{CC1} = AV_{CC2} = 5.5\text{ V}$ $AV_{IN} = 5.5\text{ V}$	—	0.1	10	μA	
Output resistance	R_{OUT}	VOUT YOUT COUT VKOUT	$V_{CC} = AV_{CC1} = AV_{CC2} = 4.5\text{ V}$ $I_{OL} = 100\text{ }\mu\text{A}$	100	—	1800	Ω	

(Continued)

MB90092

Parameter	Symbol	Pin	Conditions	Values			Unit	Remarks
				Min.	Typ.	Max.		
Yellow High level	V _{YELH}	V _{OUT}	V _{CC} = AV _{CC1} = AV _{CC2} = 5.0 V	2.89	3.00	3.11	V	See Figure 7.
Yellow Low level	V _{YELL}			2.03	2.14	2.25	V	
Cyan High level	V _{CYAH}			2.89	3.00	3.11	V	
Cyan Low level	V _{CYAL}			1.63	1.74	1.85	V	
Green High level	V _{GREH}			2.66	2.77	2.88	V	
Green Low level	V _{GREL}			1.63	1.74	1.85	V	
Magenta High level	V _{MAGH}			2.49	2.60	2.71	V	
Magenta Low level	V _{MAGL}			1.46	1.57	1.68	V	
Red High level	V _{REDH}			2.49	2.60	2.71	V	
Red Low level	V _{REDL}			1.23	1.34	1.45	V	
Blue High level	V _{BLUH}			2.15	2.26	2.37	V	
Blue Low level	V _{BLUL}			1.23	1.34	1.45	V	
Color burst High level	V _{BSTH}			1.80	1.91	2.02	V	
Color burst Low level	V _{BSTL}			1.12	1.23	1.34	V	
Color burst Low level	V _{BSTL}			1.12	1.23	1.34	V	

(Continued)

Parameter	Symbol	Pin	Conditions	Values			Unit	Remarks
				Min.	Typ.	Max.		
White level 3 $\phi = 270^\circ$	V_{WHT3} Y_{WHT3}	V_{OUT} Y_{OUT}	$V_{CC} = AV_{CC1} = AV_{CC2} = 5.0\text{ V}$	2.83	2.94	3.05	V	See Figures 7 and 8.
White level 2 $\phi = 180^\circ$	V_{WHT2} Y_{WHT2}			2.72	2.83	2.94	V	
White level 1 $\phi = 90^\circ$	V_{WHT1} Y_{WHT1}			2.60	2.71	2.82	V	
White level 0 $\phi = 0^\circ$	V_{WHT0} Y_{WHT0}			2.49	2.60	2.71	V	
Gray level 6	V_{GRY6} Y_{GRY6}			2.43	2.54	2.65	V	
Gray level 5	V_{GRY5} Y_{GRY5}			2.26	2.37	2.48	V	
Gray level 4	V_{GRY4} Y_{GRY4}			2.15	2.26	2.37	V	
Gray level 3	V_{GRY3} Y_{GRY3}			1.98	2.09	2.20	V	
Gray level 2	V_{GRY2} Y_{GRY2}			1.86	1.97	2.08	V	
Gray level 1	V_{GRY1} Y_{GRY1}			1.69	1.80	1.91	V	
Black level 3 $\phi = 270^\circ$	V_{BLK3} Y_{BLK3}			1.92	2.03	2.14	V	
Black level 2 $\phi = 180^\circ$	V_{BLK2} Y_{BLK2}			1.80	1.91	2.02	V	
Black level 1 $\phi = 90^\circ$	V_{BLK1} Y_{BLK1}			1.69	1.80	1.91	V	
Black level 0 $\phi = 0^\circ$	V_{BLK0} Y_{BLK0}			1.57	1.68	1.79	V	
Pedestal level	V_{PDS} Y_{PDS}			1.46	1.57	1.68	V	
SYNC level	V_{TIP} Y_{TIP}		0.84	1.00	1.16	V		

(Continued)

MB90092

(Continued)

Parameter	Symbol	Pin	Conditions	Values			Unit	Remarks
				Min.	Typ.	Max.		
Yellow High level	C _{YELH}	C _{OUT}	V _{CC} = AV _{CC1} = AV _{CC2} = 5.0 V	1.92	2.03	2.14	V	See Figure 9.
Yellow Low level	C _{YELL}			1.00	1.11	1.22	V	
Cyan High level	C _{CYAH}			2.09	2.20	2.31	V	
Cyan Low level	C _{CYAL}			0.89	1.00	1.11	V	
Green High level	C _{GREH}			1.98	2.09	2.20	V	
Green Low level	C _{GREL}			0.95	1.06	1.17	V	
Magenta High level	C _{MAGH}			1.98	2.09	2.20	V	
Magenta Low level	C _{MAGL}			0.95	1.06	1.17	V	
Red High level	C _{REDH}			2.09	2.20	2.31	V	
Red Low level	C _{REDL}			0.89	1.00	1.11	V	
Blue High level	C _{BLUH}			1.92	2.03	2.14	V	
Blue Low level	C _{BLUL}			1.00	1.11	1.22	V	
Color burst High level	C _{BSTH}			1.80	1.91	2.02	V	
Color burst Low level	C _{BSTL}			1.12	1.23	1.34	V	
Pedestal level	C _{PDSC}			1.46	1.57	1.68	V	

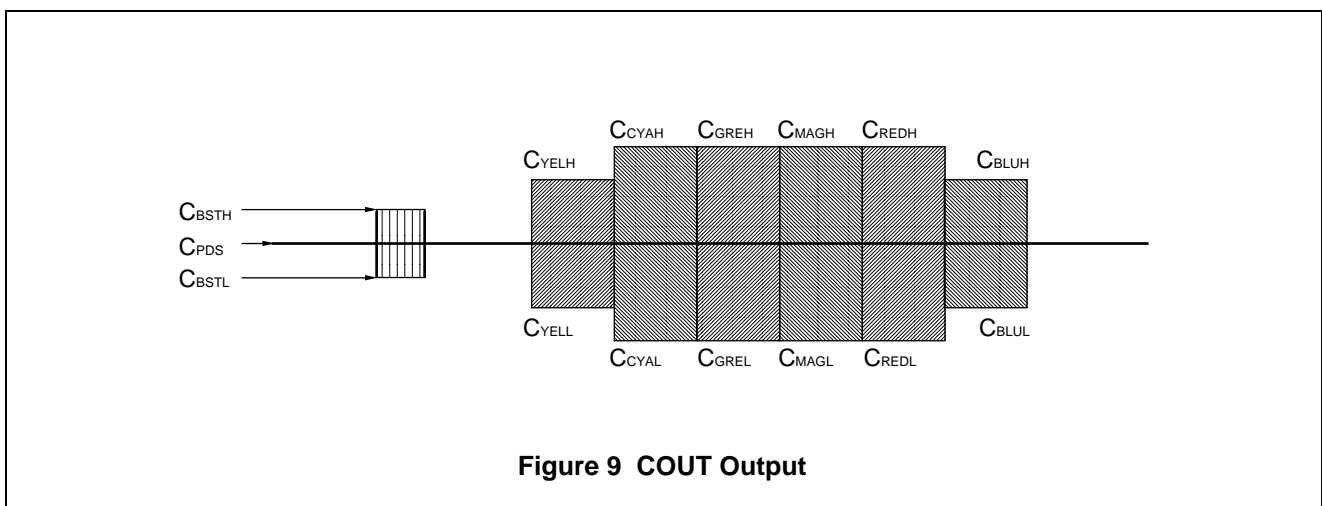
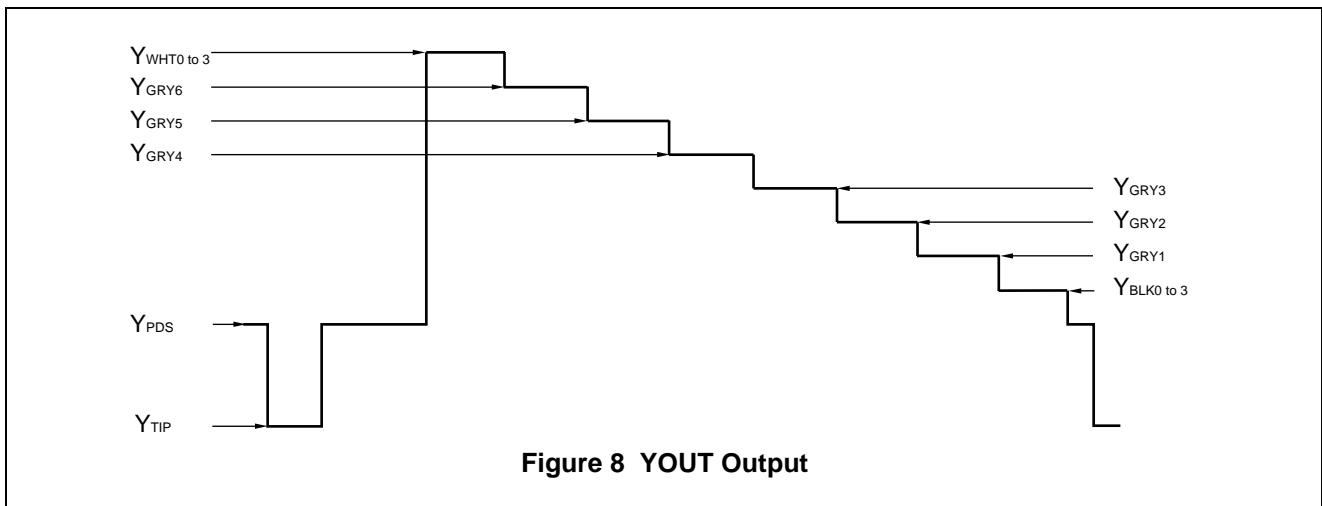
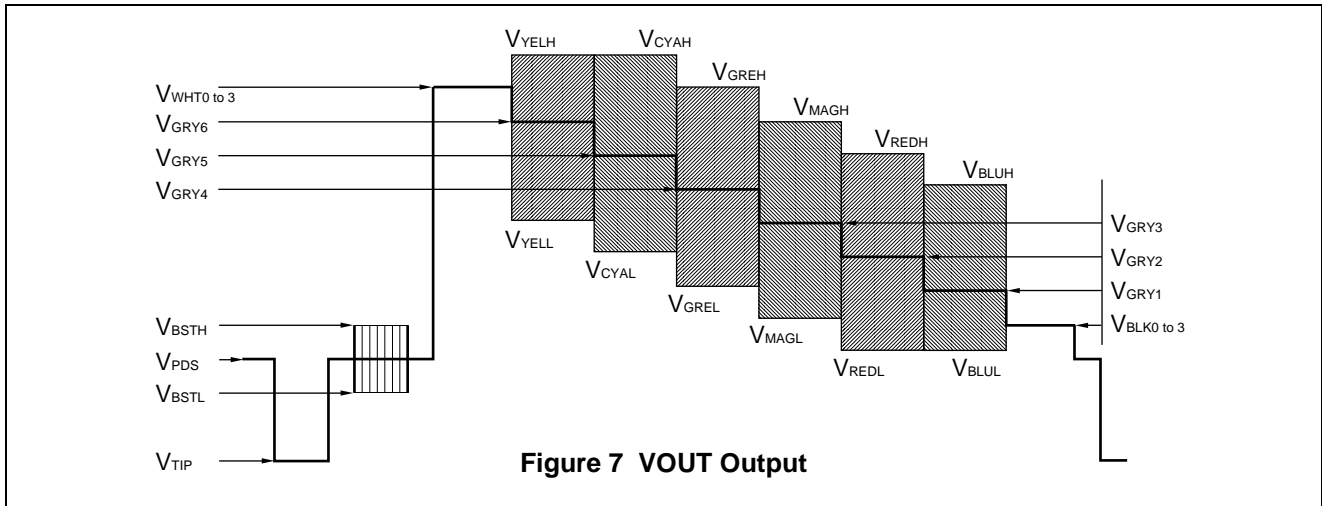

2. AC Characteristics

(Ta = -40°C to +85°C, Vcc = 5.0 V±10%, Vss = 0 V)

Parameter	Symbol	Pin	Values		Unit	Remarks
			Min.	Max.		
Shift clock cycle time	t _{CYC}	SCLK	1000	—	ns	See Figure 10.
Shift clock pulse width	t _{WCH}	SCLK	450	—	ns	
	t _{WCL}		450	—	ns	
Shift clock signal rise/fall time	t _{CR}	SCLK	—	200	ns	
	t _{CF}		—	200	ns	
Shift clock start time	t _{SS}	SCLK	200	—	ns	
Data setup time	t _{SU}	SIN	200	—	ns	
Data hold time	t _H	SIN	100	—	ns	
Chip select end time	t _{EC}	\overline{CS}	500	—	ns	
Chip select signal rise/fall time	t _{CRC}	\overline{CS}	—	200	ns	
	t _{CFC}		—	200	ns	
Horizontal sync signal rise time	t _{HR}	\overline{EXHSYN}	—	200	ns	See Figure 11.
Horizontal sync signal fall time	t _{HF}	\overline{EXHSYN}	—	200	ns	
Vertical sync signal rise time	t _{VR}	\overline{EXVSYN}	—	200	ns	
Vertical sync signal fall time	t _{VF}	\overline{EXVSYN}	—	200	ns	
Horizontal sync signal pulse width *1	t _{WH}	\overline{EXHSYN}	4.0	8.0	μs	
Vertical sync signal pulse width *1	t _{WV}	\overline{EXVSYN}	1	5	H	
Horizontal sync detection pulse width *2	t _{WH}	\overline{EXHSYN}	4.0	8.0	μs	
Vertical sync detection pulse width *2	t _{WH}	\overline{EXHSYN}	13	28	μs	
Reset input pulse width	t _{WR}	\overline{IC} ($\overline{TEST} = \text{Low}$)*3	10	—	μs	See Figure 12.

*1: The values assume H/V-separated sync signal input.

*2: The values assume composite sync signal input.

*3: When the \overline{TEST} pin is a Low-level input, the \overline{IC} pin serves as a reset pin input. (The \overline{IC} and \overline{TEST} pins can be Low level at the same time.)

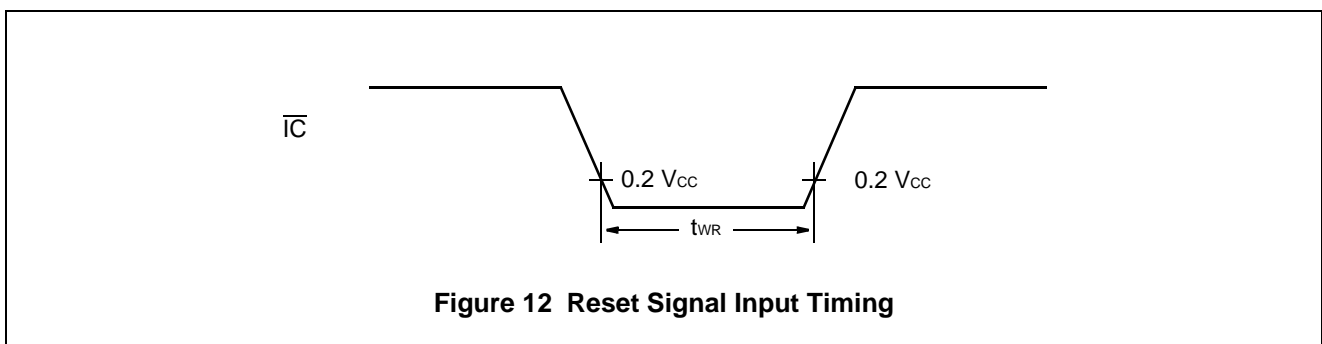
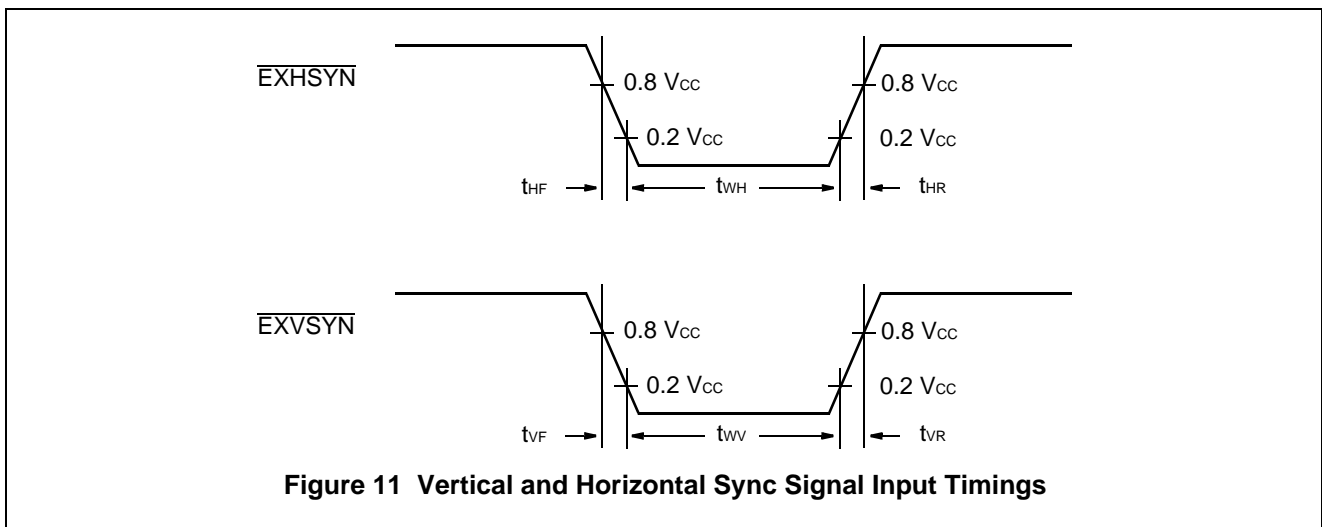
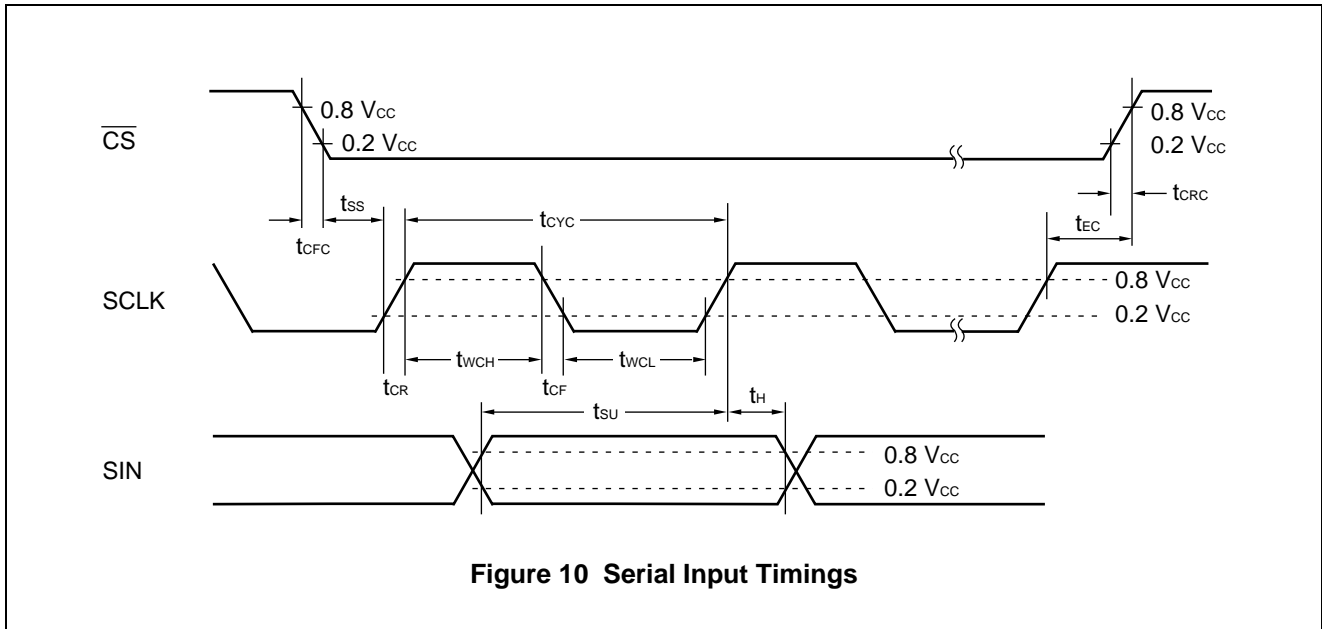

MB90092

Parameter	Symbol	Pin	Values		Unit	Remarks
			Min.	Max.		
ROM read cycle *1	t_{rcyc}	\overline{EXD}	250	500	ns	See Figure 13.
Address valid delay	t_{ab}	ADR0 to ADR20	—	60	ns	
\overline{READ} active delay	t_{ra}	\overline{READ}	—	38	ns	
Read data setup time	t_{ds}	DA0 to DA7	30	—	ns	
Read data hold time	t_{dh}	DA0 to DA7	30	—	ns	
Address invalid delay	t_{ai}	ADR0 to ADR20	0	—	ns	
\overline{READ} inactive delay	t_{ri}	\overline{READ}	0	—	ns	
Tristate address delay	t_{tad}	ADR0 to ADR20	—	100	ns	See Figure 14.
Tristate \overline{READ} delay	t_{trd}	\overline{READ}	—	100	ns	

*1: Depends on the dot clock oscillation frequency. ($t_{rcyc} = 4/f_{DC}$)

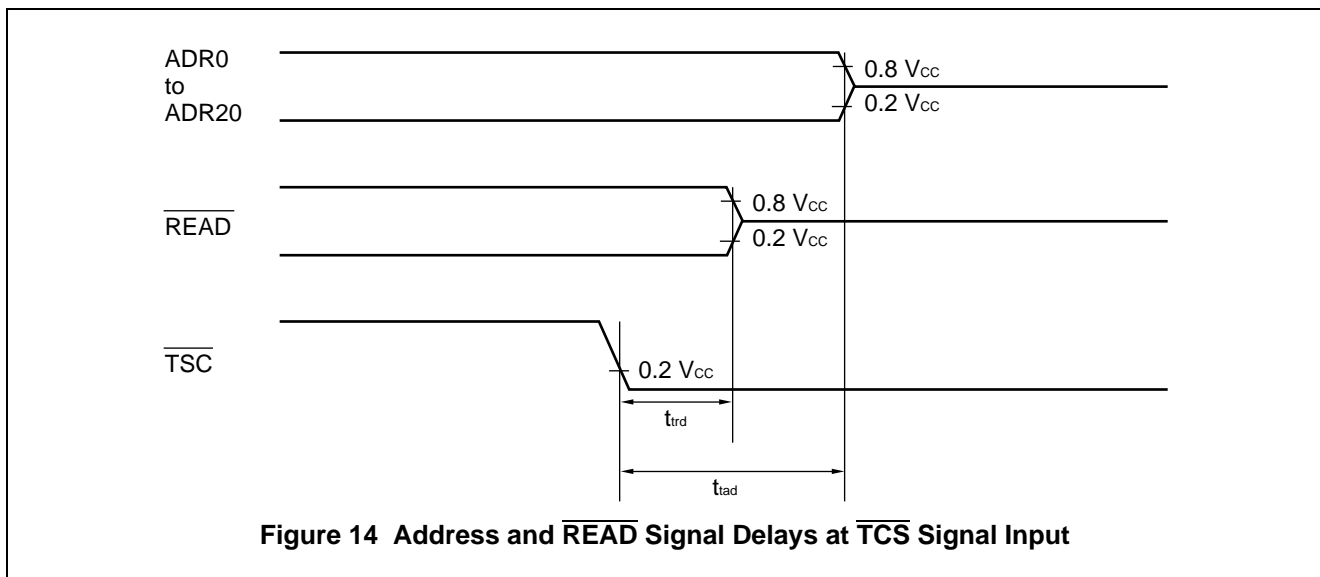
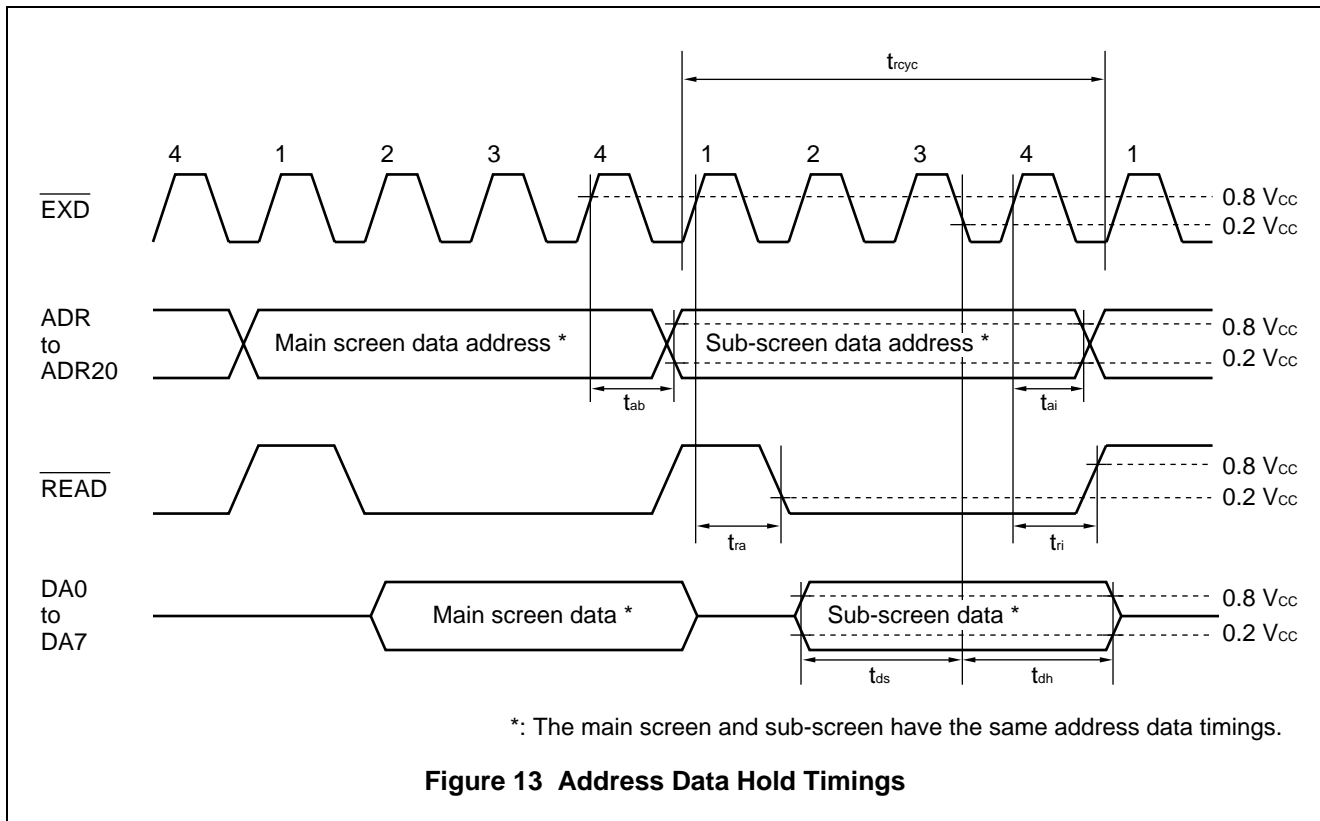

3. Clock Timing Specifications

Parameter	Symbol	Pin	Values			Unit	Remarks
			Min.	Typ.	Max.		
Display dot clock *	f_{DC}	EXD XD	8	—	16	MHz	
Color burst clock (NTSC) *	4 f_{SC}	EXS XS	—	14.318185	—	MHz	
Color burst clock (PAL) *			—	17.734475	—	MHz	

* : Input the signal with a duty cycle of 50%.

4. Power-on Reset Specifications

($T_a = -40^{\circ}\text{C}$ to $+85^{\circ}\text{C}$)

Parameter	Symbol	Pin	Values		Unit	Remarks
			Min.	Max.		
Power-supply rise time	t_r	V_{CC}	0.05	50	ms	Conditions which activate the power-on reset circuit. (Figure 15)
Power-supply off time	t_{off}		1	—	ms	Conditions in which the circuit repeatedly operate normally. (Figure 15)
Time after power-supply rise	t_{WIT}	\overline{CS}	450	—	ns	Power-on reset cancel timing (See Figure 16.)
Reset cancel pulse width	t_{WRH}		450	—	ns	
	t_{WRL}		450	—		

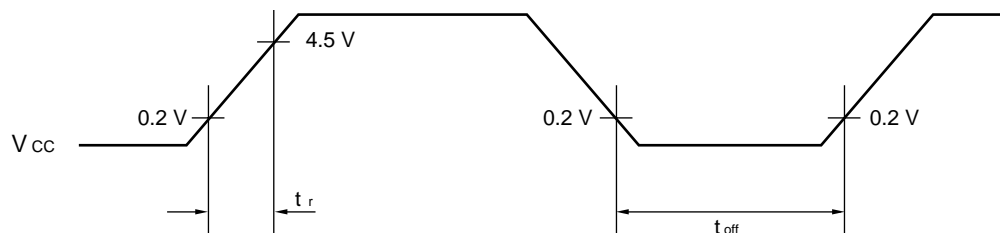

Note: The power supply must be activated smoothly.

Figure 15 Power ON/OFF Timing

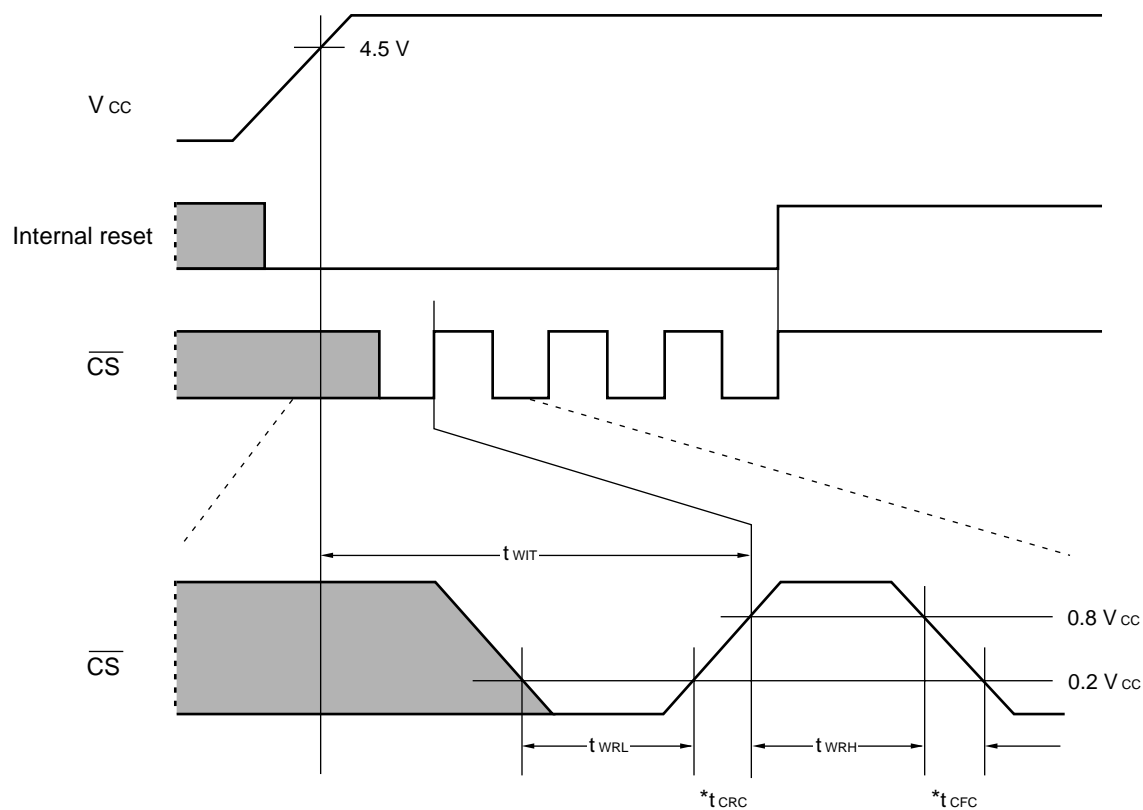

* : See Section 4, "AC Characteristics".

Figure 16 Power-on Reset Cancel Timing

5. Recommended Input Timings

(a) Composite sync signal input timing

Parameter	NTSC	PAL	Unit	Remarks
Number of frame scan lines	525	625	Lines	
Field frequency	60 (59.94)	50	Hz	*1
Line frequency	15750 (15734.264)	15625	Hz	*1
Vertical retrace blanking interval	19 to 21	25	H	*2
First equalizing pulse interval	3	2.5	H	*2
Vertical sync pulse interval	3	2.5	H	*2
Second equalizing pulse interval	3	2.5	H	*2
Equalizing pulse width	2.29 to 2.54	2.34 to 2.36	μs	
Equalizing pulse cycle	0.5	0.5	H	*2
Cut-in pulse width	3.81 to 5.34	4.5 to 4.9	μs	
Cut-in pulse cycle	0.5	0.5	H	*2
Horizontal sync signal cycle	63.492 (63.5555)	64	μs	
Horizontal sync signal pulse width	4.19 to 5.71 (4.7±0.1)	4.5 to 4.9	μs	*1
Horizontal retrace blanking interval	10.2 to 11.4 (10.5 to 11.4)	11.7 to 12.3	μs	*1

*1: Parenthesized values are specifications for color information display.

*2: 1 H is assumed to be one horizontal sync signal period.

(b) H/V-separated sync signal input timing

Parameter	NTSC	PAL	Unit	Remarks
Vertical sync signal frequency	60 (59.94)	50	Hz	*1
Vertical sync signal pulse width	1 to 5	1 to 4	H	*2
Horizontal sync signal frequency	63.492 (63.5555)	64	μs	*1
Horizontal sync signal pulse width	4.19 to 5.71 (4.7±0.1)	4.5 to 4.9	μs	*1

*1: Parenthesized values are specifications for color information display.

*2: 1 H is assumed to be one horizontal sync signal period.

6. Output Timings

(a) Horizontal timing

Symbol	NTSC	PAL	Remarks
HPS	0	0	See Figure 17.
EQP1E	34	42	
HPE	68	84	
BSTS	76	100	
BSTE	112	140	
HBLKE	143	186	
SEP1S	388	484	
EQP2S	455	568	
EQP2E	489	610	
SEP2S	842	1050	
HBLKS	888	1106	
IHCLR	910	1135 * (1137)	

Note: The values in the above list are 4fsc count values.

* : Parenthesized values assume the last raster in each V cycle (field).

(b) Vertical timing

Symbol	NTSC		PAL		Remarks
	Interlaced	Noninterlaced	Interlaced	Noninterlaced	
VPS	0	0	0	0	See Figures 18 (NTSC) and 19 (PAL).
VPE	6	6	5	5	
EQPE	12	12	10	10	
VBLKE	36	36	45	45	
VBLKS	519	519	620	620	
VPS	525	526	625	624	

Note: The values in the above list are 1/2H count values.

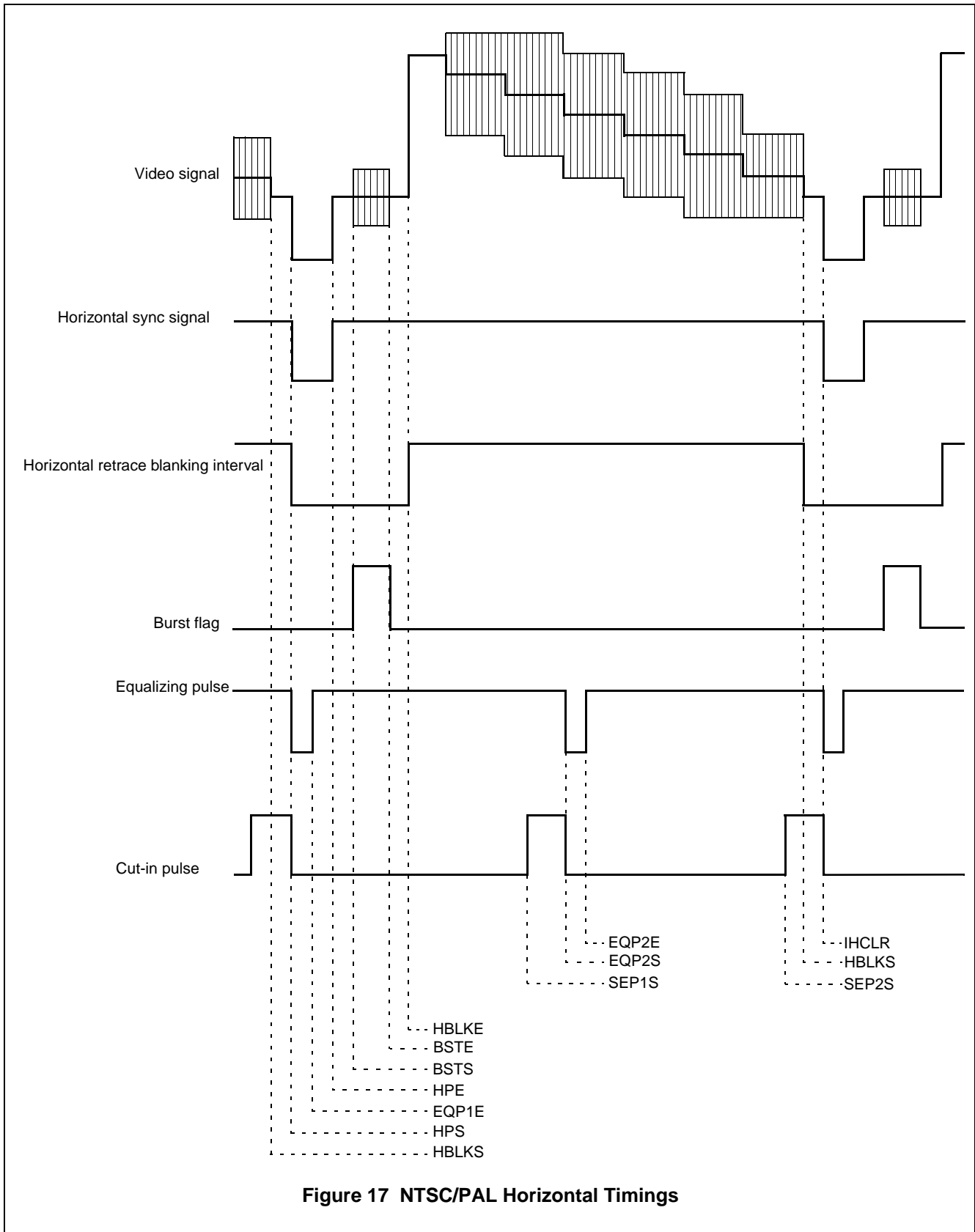

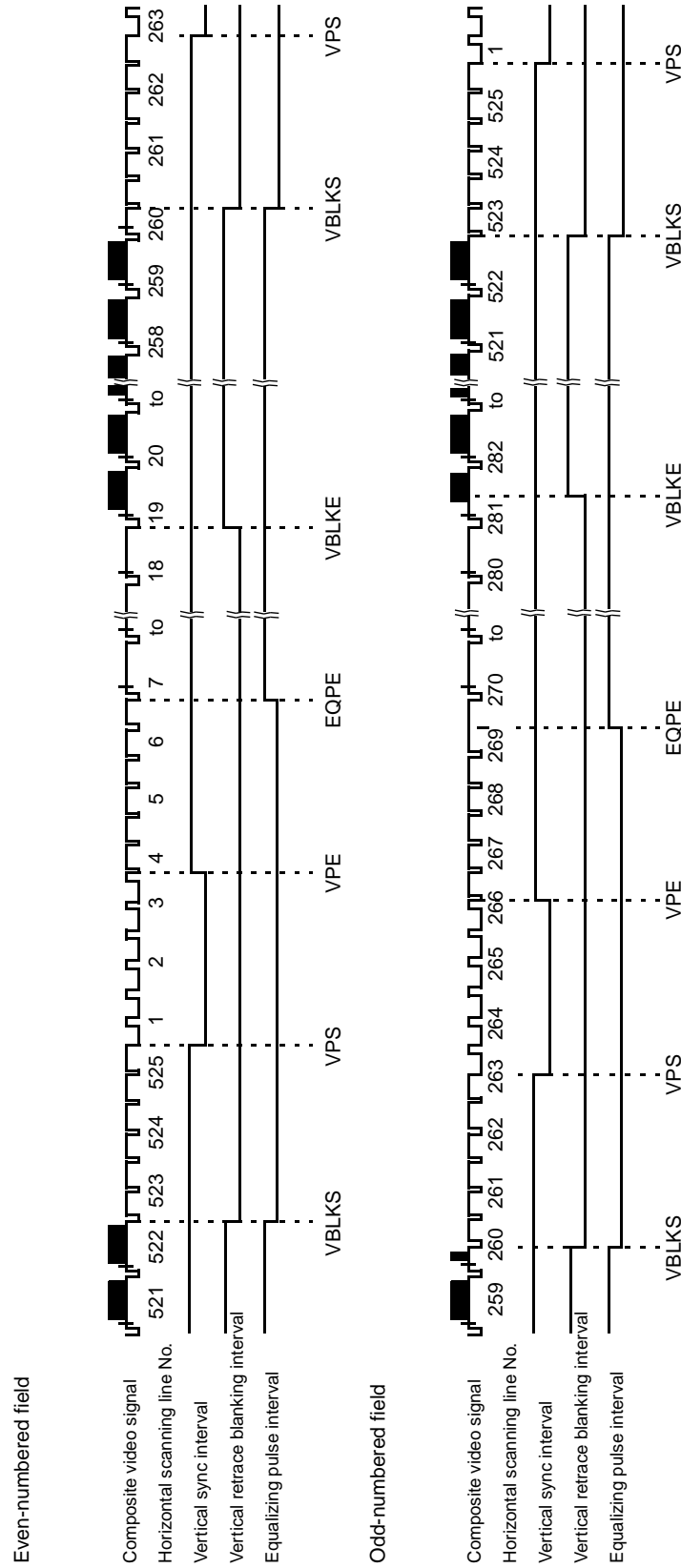

Figure 18 NTSC Vertical Timings

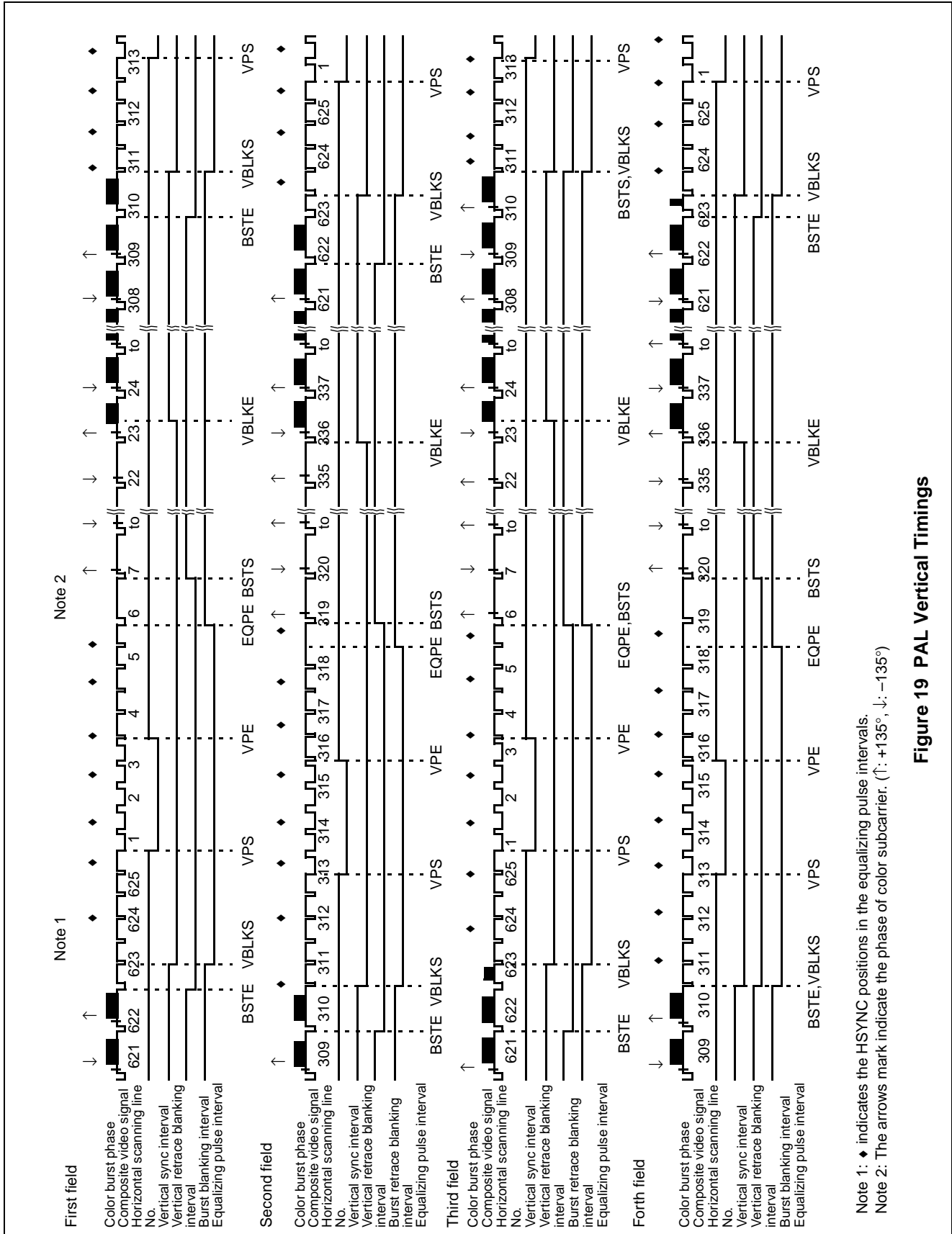

Figure 19 PAL Vertical Timings

■ DISPLAY CONTROL COMMANDS

Table 1 lists the MB90092 display control commands.

Table 1 List of Display Control Commands

Command no.	First byte				Second byte								Function
	Command code/data				Data								
	76543	2	1	0	7	6	5	4	3	2	1	0	
0	10000	VSL	RA8	RA7	0	RA6	RA5	CA4	CA3	CA2	CA1	CA0	VRAM address setting
1-1	10001	MA	MB	AT	0	CG	CR	CB	MC	BG (GR)	BR (BS)	BB (MD)	Main screen character control 1*
2-1	10010	M9	M8	M7	0	M6	M5	M4	M3	M2	M1	M0	Main screen character control 2
1-2	10001	SMA	SMB	0	0	SCG	SCR	SCB	SMC	SGR	SDC	SMD	Sub-screen line control 1
2-2	10010	SM9	SM8	SM7	0	SM6	SM5	SM4	SM3	SM2	SM1	SM0	Sub-screen line control 2
1-3	10001	OF1	OF0	0	0	0	0	0	PC	PG	PR	PB	Main screen line control 1
2-3	10010	G2	G1	G0	0	SOC	VD	DG	KC	KG	KR	KB	Main screen line control 2
3	10011	FIL	0	0	0	0	0	0	0	0	0	0	VRAM write control
4	10100	IE	IN	EB	0	EO	CM	ZM	NP	P2	P0	DC	Screen control 1
5	10101	KID	APC	GYZ	0	BH2	BH1	BH0	W3	W2	W1	W0	Screen control 2
6	10110	G2	G1	G0	0	SOC	VD	DG	N3	N2	N1	N0	Main screen line control 3
7	10111	EC	LP	FO	0	0	Y5	Y4	Y3	Y2	Y1	Y0	Main screen vertical position control
8	11000	SC	0	FC	0	0	X5	X4	X3	X2	X1	X0	Main screen horizontal position control
9	11001	0	0	GRM	0	0	0	0	0	0	0	0	Kanji font display control
10	11010	0	0	RB	0	BK	CC	BC	UC	UG	UR	UB	Color control
11	11011	SG2	SG1	SG0	0	0	SCC	SBC	SGC	SBG	SBR	SBB	Sub-screen control
12	11100	SGA	0	SY7	0	SY6	SY5	SY4	SY3	SY2	SY1	SY0	Sub-screen vertical position control
13	11101	0	SX8	SX7	0	SX6	SX5	SX4	SX3	SX2	SX1	SX0	Sub-screen horizontal position control
14	11110	—	—	—	0	—	—	—	—	—	—	—	(Reserved)
15	11111	—	—	—	0	—	—	—	—	—	—	—	(Reserved)

* : Parenthesized bit names are used for extended graphics mode.

1. Command 0 (VRAM Address Setting)

[Command format]

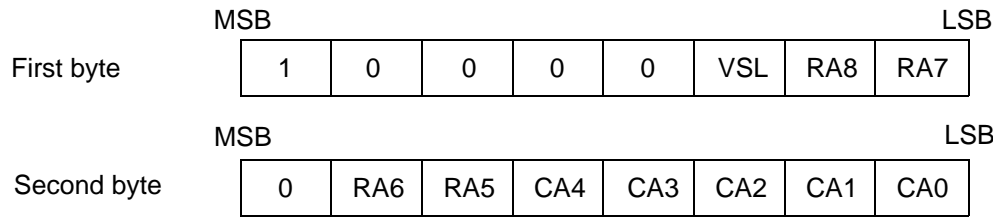

VSL : VRAM write control
 RA8 to RA5 : VRAM row address setting (00 to B_H)
 CA4 to CA0 : VRAM column address setting (00 to 17_H)

[Description]

VSL : VRAM write control
 RA8 to RA5 : VRAM row address setting (00 to B_H)
 CA4 to CA0 : VRAM column address setting (00 to 17_H)

VSL	RA8	RA7	RA6	RA5	CA4	CA3	CA2	CA1	CA0	Operation
0	Row address (0 to B _H)				Column address (0 to 17 _H)					Set the main screen character control RAM address.
1	Row address (0 to B _H)				—	—	—	—	0	Set the sub screen row control RAM address.
	Row address (0 to B _H)				—	—	—	—	1	Set the main screen row control RAM address.

(1) In normal mode (Command 9: GRM = 0)

MC to M0 : Set a character code.
 The character code can be specified between 0000_H to 1FFF_H.
 Up to 8192 different characters can be used.

AT : Specify character attribute display.
 AT = 0 : Specify normal display.
 AT = 1 : Specify attribute display.
 Solid-fill background (when command 10: RB = 1)
 Blinking (when command 10: BK = 1)
 Shaded background (when command 1: BS = 1)
 Note: If shaded background display and solid-fill background display or blinking display are specified, the shaded background display setting takes priority over the other setting.

CG, CR, CG : Character colors
 BG, BR, BB : Character background colors

CG/BG	CR/BR	CB/BB	Character color signal output/Character background color signal output				
			Digital output			Video output	
			G	R	B	Color	Monochrome
0	0	0	L	L	L	Black	Gray 0 (Black)
0	0	1	L	L	H	Blue	Gray 1
0	1	0	L	H	L	Red	Gray 2
0	1	1	L	H	H	Magenta	Gray 3
1	0	0	H	L	L	Green	Gray 4
1	0	1	H	L	H	Cyan	Gray 5
1	1	0	H	H	L	Yellow	Gray 6
1	1	1	H	H	H	White	Gray 7 (White)

(2) In extended graphics mode (Command 9: GRM = 1)

MD to M0 : Set a character code.

The character code can be specified between 0000_H to 3FFF_H.

Up to 16384 different characters can be used.

AT : Specify character attribute display.

AT = 0 : Specify normal display.

AT = 1 : Turn attribute display ON.

Solid-fill background (when command 10: RB = 1)

Blinking (when command 10: BK = 1)

Shaded background (when command 1: BS = 1)

Note: If shaded background display and solid-fill background display or blinking display are specified, the shaded background display setting takes priority over the other setting.

GR : Specify normal character/graphic character display.

GR = 0 : Specify normal character display.

Characters made up of 24 horizontal dots × 32 vertical dots

GR = 1 : Specify graphic character display

Characters made up of 8 horizontal dots × 32 vertical dots (color settable for each dot)

Note: Do not set BS = 1.

BS : Specify shaded background display.

BS = 0 : Specify normal display.

BS = 1 : Specify shaded background display.

Characters for which AT = 0 has been set are shaded on the background.

Characters for which AT = 1 has been set are shaded on the background in reverse video.

2. Commands 1 and 2 (VRAM Data Settings 1 and 2)

Writing main screen character control data (when command 0: VSL = 0)

[Command format]

Command 1-1 (Main screen character control data setting 1)

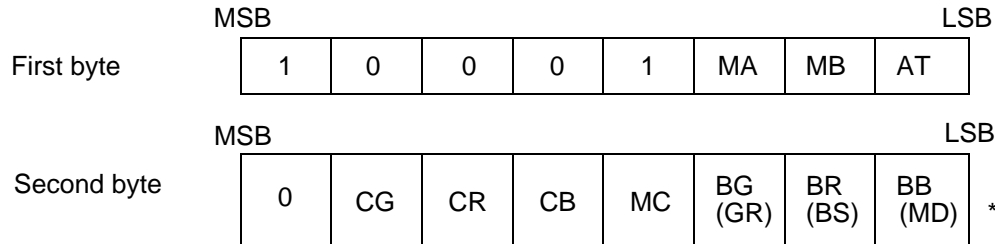

*: Parenthesized bit names are used for extended graphics mode.

Command 2-1 (Main screen character control data setting 2)

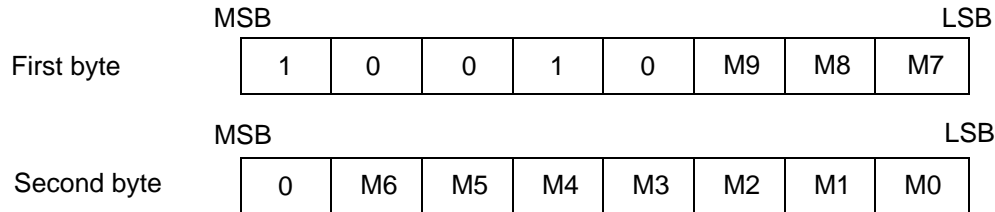

- (MD), MC to M0 : Character code
- AT : Specify character attribute display.
- CG, CR, CB : Character colors
- BG, BR, BB : Character background colors
- (GR) : Specify normal character/graphic character display.
- (BS) : Specify shaded background display.

(1) In normal character display mode (GR = 0)

CG, CR, CB : Character colors

(2) In graphic character display mode (GR = 1)

CG : Graphic color transparency control

CG = 0 : Normal display

CG = 1 : Transparent display

This setting replaces the "black" graphic color display with transparent display.

CR, CB : Graphic color phase control

These bits control the color phase of video signal outputs (VOUT pin and COUT pin outputs).

CR	CB	Graphic color phase
0	0	+0 degree
0	1	+90 degrees
1	0	+180 degrees
1	1	+270 degrees

Writing sub-screen line control data (when command 0: VSL = 1, CA0 = 0)

Set sub-screen line control data.

[Command format]

Command 1-2 (Sub-screen line control data setting 1)

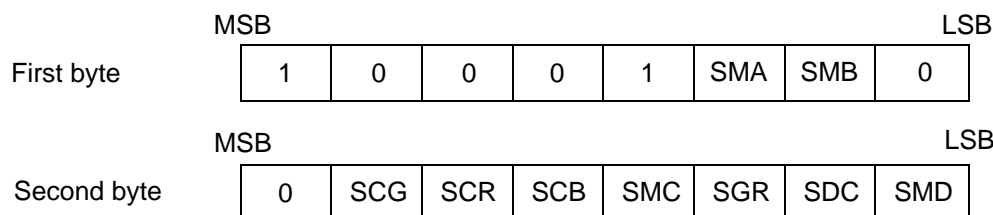

Command 2-2 (Sub-screen line control data setting 2)

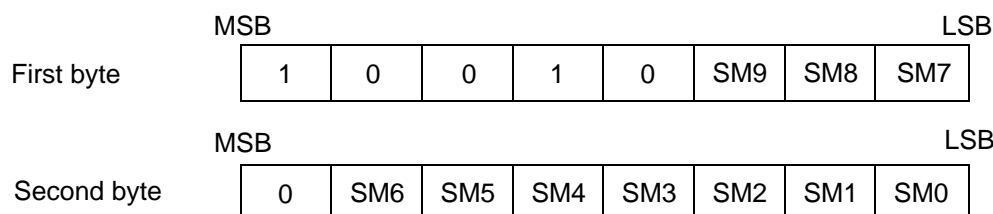

- SMD to SM0 : Sub-screen line first character code
- SDC : Sub-screen line output control
- SGR : Sub-screen line character display control
- SCG to SCB : Sub-screen line character colors (when SGR = 0)
- SCG : Sub-screen line graphic color transparency control (when SGR = 1)
- SCR, SCB : Sub-screen line graphic color phase control (when SGR = 1)

[Description]

SMD to SM0: Sub-screen line first character code

SDC: Sub-screen line output control

SDC = 0 : Disable sub-screen line display output.

SDC = 1 : Enable sub-screen line display output.

SGR: Sub-screen line character display control

SGR = 0 : Display normal characters.

SGR = 1 : Display graphic characters.

(1) In sub-screen line normal character display mode (SGR = 0)

SCG to SCB : Sub-screen line character colors

(2) In sub-screen line graphic character display mode (SGR = 1)

SCG : Sub-screen line graphic color transparency control

SCG = 0: Normal display

SCG = 1: Transparent display

This setting replaces "black" graphic color display with transparent display.

SCR, SCB : Sub-screen line graphic color phase control

These bits control the color phase of graphic character video signal outputs (VOUT pin and COUT pin outputs).

SCR	SCB	Sub-screen line graphic color phase
0	0	+0 degree
0	1	+90 degrees
1	0	+180 degrees
1	1	+270 degrees

Writing main screen control data (when command 0: VSL = 1, CA0 = 1)

[Command format]

Command 1-3 (Main screen line control data setting 1)

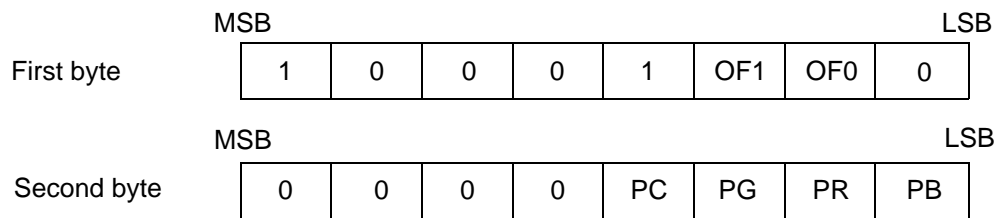

Command 2-3 (Main screen line control data setting 2)

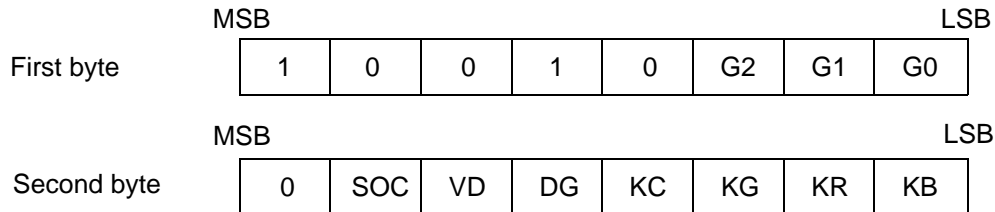

- OF1, OF0 : Character color phase control
- PC : Shaded pattern background color/monochrome control
- PG, PR, PB : Shaded pattern background color
- G2, G1, G0 : Character size control
- SOC : Output priority control
- VD : Video signal output control
- DG : Digital signal output control
- KC : Line background color/monochrome control
- KG, KR, KB : Line background color

[Description]

OF1, OF0 : Character color phase control

OF1	OF0	Character color phase
0	0	+0 degree
0	1	+90 degrees
1	0	+180 degrees
1	1	+270 degrees

PC : Shaded pattern background color/monochrome control (Valid only in extended graphics mode)
 PC = 0 : Display the shaded pattern background of video signal outputs in monochrome.
 PC = 1 : Display the shaded pattern background of video signal outputs in color.

PG, PR, PB: Shaded pattern background color (Valid only in extended graphics mode)

G2 to G0 : Character size

G2	G1	G0	Character size
0	0	0	Standard
0	0	1	Double width
0	1	0	Double width × double height
0	1	1	Quadruple width × double height
1	0	0	Standard
1	0	1	Double width
1	1	0	Double width × double height
1	1	1	Double height

SOC : Output priority control
 SOC = 0 : Give display priority to the main screen.
 This setting displays the main screen on top of the sub-screen.
 SOC = 1 : Give display priority to the sub-screen.
 This setting displays the sub-screen on top of the main screen.

VD : Video signal output control
 VD = 0 : Disable output of main screen character information to the video output pin (VOUT, YOUT, or COUT pin).
 VD = 1 : Output main screen character information to the video output pins (VOUT, YOUT, and COUT pins).

DG : Digital signal output control
 DG = 0 : Disable output of main screen character information to the digital output pin (G, R, B, VOB, or VOC pin).
 DG = 1 : Output main screen character information to the digital output pins (G, R, B, VOB, and VOC pins).

KC : Line background color/monochrome control
 (Valid only in extended graphics mode)
 KC = 0 : Display the line background of video signal outputs in monochrome.
 KC = 1 : Display the line background of video signal outputs in color.

KG, KR, KB: Line background color
 (Valid only in extended graphics mode)

3. Command 3 (VRAM Write Control)

[Command format]

	MSB									LSB
First byte	1	0	0	1	1	FIL	0	0		

	MSB									LSB
Second byte	0	0	0	0	0	0	0	0		

FIL: VRAM fill control

[Description]

FIL : VRAM fill control
 FIL = 0: Do not fill VRAM.
 FIL = 1: Fill VRAM.

VSL	CA0	Area to be filled
0	—	Main screen character control RAM
1	0	Sub-screen line control RAM
1	1	Main screen line control RAM

4. Command 4 (Screen Control 1)

[Command format]

	MSB									LSB
First byte	1	0	1	0	0	IE	IN	EB		

	MSB									LSB
Second byte	0	EO	CM	ZM	NP	P2	P0	DC		

IE : Internal/external synchronization control
 IN : Interlaced/noninterlaced display control
 EB : Screen background display control
 EO : Field control
 CM : Color/monochrome display control
 ZM : Zoom-in control
 NP : NTSC/PAL control
 P2, P0 : Pattern background control
 DC : Display control

[Description]

IE : Internal/external synchronization control
 IE = 0 : Specify internal synchronization control operation.
 IE = 1 : Specify external synchronization control operation.

IN : Interlaced/noninterlaced display control
 IN = 0 : Specify interlaced scan display.
 IN = 1 : Specify noninterlaced scan display.

- EB : Screen background display control
EB = 0: Specify normal display.
EB = 1: Display the screen background.
- EO : Field control
EO = 0: Specify normal display.
EO = 1: Replace display output data to the even-numbered and odd-numbered fields with each other.
Display output data to each field is replaced with that to the other when the horizontal/vertical separated sync signal input involves phase shift during external synchronization control operation.
- CM : Color/monochrome display control
CM = 0: Monochrome display
CM = 1: Color display
- ZM : Zoom-in control
ZM = 0: Normal display
ZM = 1: Zoom into the main screen.
- NP : NTSC/PAL control
NP = 0: Output display signals using the NTSC system.
NP = 1: Output display signals using the PAL system.
- P2, P0 : Pattern background control
Specify the pattern background mode for normal character display.

P2	P0	Pattern background mode
0	0	Pattern background 1
0	1	Pattern background 0
1	0	Pattern background 2
1	1	Pattern background 3

Figure 3 shows examples of pattern background display.

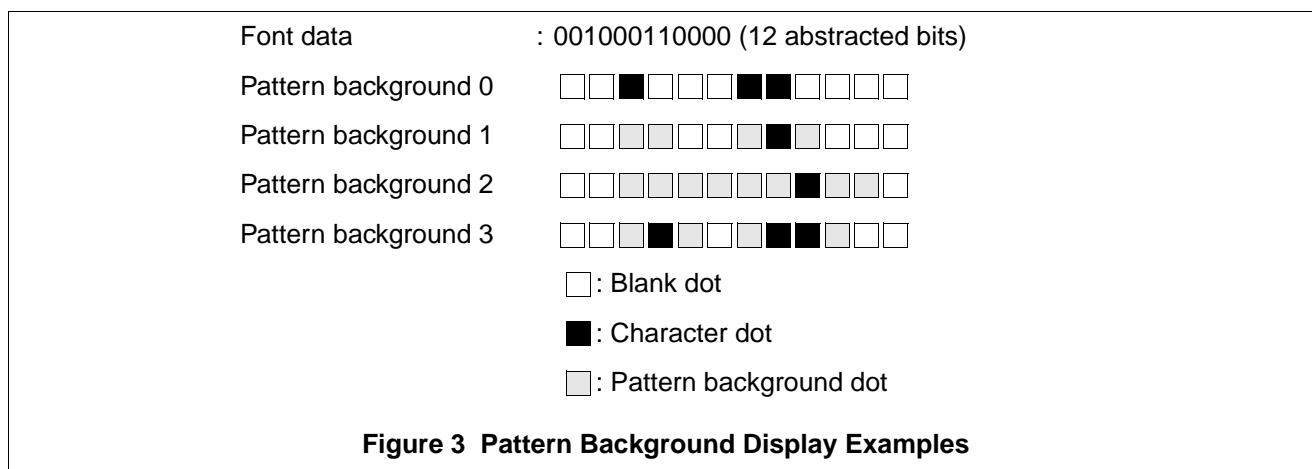

- DC : Display control
DC = 0: Display neither the main screen nor the sub-screen.
Only the screen background can be displayed.
DC = 1: Enable display output operation.

5. Command 5 (Screen Control 2)

[Command format]

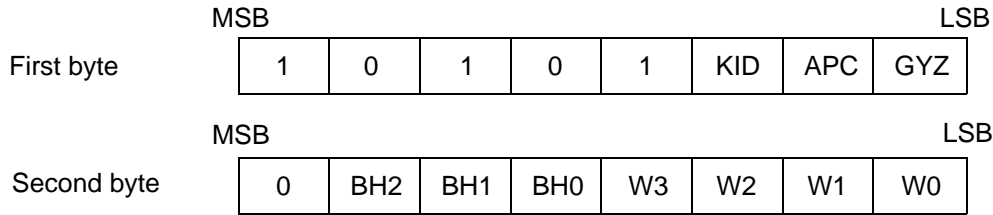

- KID : Halftone control
- APC : APC control
- GYZ : Main screen line enlargement control
- BH2 to BH0 : Color phase control
- W3 to W0 : Main screen line spacing control

[Description]

- KID : Halftone control
 KID = 0 : Perform normal display, disabling halftone display.
 KID = 1 : Enable halftone display.
- APC : APC control
 APC = 0 : Turn the APC function OFF.
 APC = 1 : Turn the APC function ON.
- GYZ : Main screen line enlargement control
 GYZ = 0 : Shift the display positions of the lines downward that follow a line on the main screen when that line is being displayed enlarged, to bring all the lines into view.
 GYZ = 1 : Undisplay (conceal) the line that follows a line on the main screen when that line is being displayed enlarged, and display the remaining lines without changing their original positions.
- BH2 to BH0 : Color phase control
 With APC turned on, these bits are used for color phase control if there is a difference between the external input color phase and internal color phase for some reason such as a circuit delay.

BH2	BH1	BH0	Color phase offset
0	0	0	0 degree
0	0	1	45 degrees
0	1	0	90 degrees
0	1	1	135 degrees
1	0	0	180 degrees
1	0	1	225 degrees
1	1	0	270 degrees
1	1	1	315 degrees

- W3 to W0 : Main screen line spacing control
 Set the line spacing on the main screen.
 The line spacing can be specified between 0 and 15 rasters in increments of one raster.

6. Command 6 (Main Screen Line Control)

[Command format]

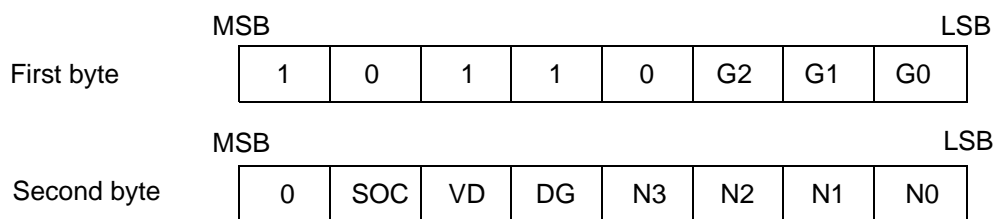

G2 to G0 : Character size control
 SOC : Output priority control
 VD : Video signal output control
 DG : Digital signal output control
 N3 to N0 : Line specification

[Description]

G2 to G0 : Character size control

G2	G1	G0	Character size
0	0	0	Standard
0	0	1	Double width
0	1	0	Double width × double height
0	1	1	Quadruple width × double height
1	0	0	Standard
1	0	1	Double width
1	1	0	Double width × double height
1	1	1	Double height

SOC : Output priority control
 SOC = 0 : Give display priority to the main screen.
 This setting displays the main screen on top of the sub-screen.
 SOC = 1 : Give display priority to the sub-screen.
 This setting displays the sub-screen on top of the main screen.

VD : Video signal output control
 VD = 0 : Disable output of main screen character information to the video output pin (VOUT, YOUT, or COUT pin).
 VD = 1 : Output main screen character information to the video output pins (VOUT, YOUT, and COUT pins).

DG : Digital signal output control
 DG = 0 : Disable output of main screen character information to the digital output pin (G, R, B, VOB, or VOC pin).
 DG = 1 : Output main screen character information to the digital output pins (G, R, B, VOB, and VOC pins).

N3 to N0 : Line specification
 Specify the line on the main screen, for which control data is to be set.
 The N3 to N0 bits correspond to the RA8 to RA5 bits for VRAM addresses.

7. Command 7 (Main Screen Vertical Display Position Control)

[Command format]

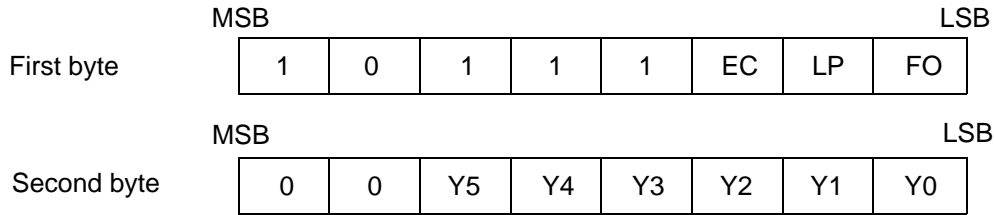

- EC : Sync signal output control
- LP : Simple NTSC/PAL control
- FO : Color phase signal output control
- Y5 to Y0 : Main screen vertical display position control

[Description]

- EC : Sync signal output control
 EC = 0 : Set the $\overline{\text{HSYNC}}$ pin as a composite sync signal output and the $\overline{\text{VSYNC}}$ pin as a fixed High-level output.
 EC = 1 : Set the $\overline{\text{HSYNC}}$ pin as a horizontal sync signal output and the $\overline{\text{VSYNC}}$ pin as a vertical sync signal output.
- LP : Simple NTSC/PAL control
 LP = 0 : Normal operation
 LP = 1 : Simple NTSC/PAL operation
- FO : Color phase signal output control
 FO = 0 : Set the FSCO pin as a fixed Low-level output
 FO = 1 : Set the FSCO pin to output the signal representing an internal color burst phase.
- Y5 to Y0 : Main screen vertical display position control (in dot units)

8. Command 8 (Main Screen Horizontal Display Position Control)

[Command format]

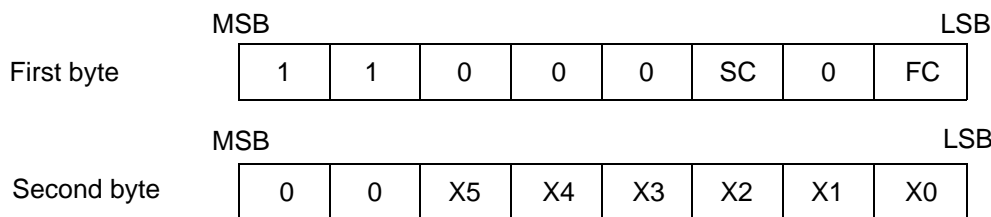

SC : Sync signal input control
 FC : Sync signal input 3 μs filter control
 X5 to X0 : Main screen horizontal display position control

[Description]

SC : Sync signal input control bit
 SC = 0 : Set the $\overline{\text{EXHSYN}}$ pin as a composite sync signal input and disable $\overline{\text{EXVSYN}}$ pin input.
 SC = 1 : Set the $\overline{\text{EXHSYN}}$ pin as a horizontal sync signal input and the $\overline{\text{EXVSYN}}$ pin as a vertical sync signal input.

FC : Sync signal input 3 μs filter control
 FC = 0 : Enable the 3 μs digital filter function of the $\overline{\text{EXHSYN}}$ pin input.
 The Low pulse signal inputs of 3 μs or less are ignored.
 FC = 1 : Disable the 3 μs digital filter function of the $\overline{\text{EXHSYN}}$ pin input.
 The input signal drives the function directly.

X5 to X0 : Main screen horizontal display position control (in 8-dot units)

9. Command 9 (Kanji Font Display Control)

[Command format]

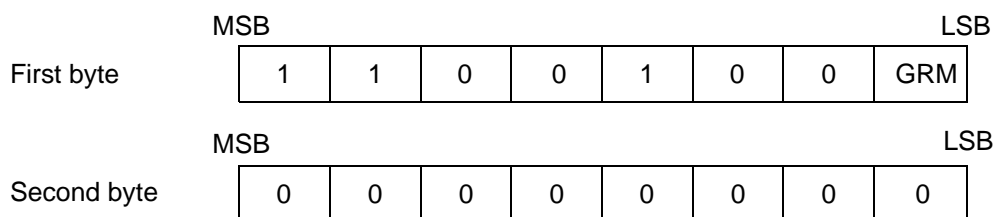

GRM : Main screen display mode control

[Description]

GRM : Main screen display mode control
 GRM = 0 : Display the main screen in normal mode.
 The main screen can display only normal characters.
 The character background color can be set for each character.
 GRM = 1 : Display the main screen in extended graphic mode.
 The main screen can display both normal and graphic characters at the same time.

10. Command 10 (Color Control)

[Command format]

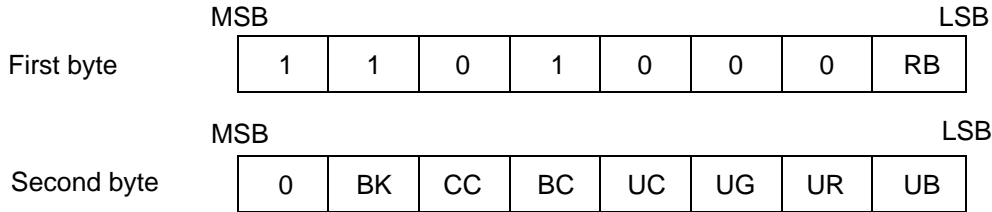

- RB : Main screen solid-fill background display control
- BK : Main screen blink display control
- CC : Main screen character color/monochrome control
- BC : Main screen character background color/monochrome control
(Main screen graphic color/monochrome control)
- UC : Screen background color/monochrome control
- UG, UR, UB : Screen background color

[Description]

- RB : Main screen solid-fill background display control
RB = 0 : Normal display
RB = 1 : The main screen is displayed with a solid-fill background.
- BK : Main screen blink display control
BK = 0 : Normal display
BK = 1 : Display characters blinking on the main screen.
- CC : Main screen character color/monochrome control
CC = 0 : Display video signal output characters on the main screen in monochrome.
CC = 1 : Display video signal output characters on the main screen in color.
- BC :
 - (1) Main screen character background color/monochrome control (in normal mode with GRM = 0)
BC = 0 : Display the background of video signal output characters on the main screen in monochrome.
BC = 1 : Display the background of video signal output characters on the main screen in color.
 - (2) Main screen character background color/monochrome control (in extended graphics mode with GRM = 1)
BC = 0 : Display video signal output graphics on the main screen in monochrome.
BC = 1 : Display video signal output graphics on the main screen in color.
- UC : Screen background color/monochrome control
UC = 0 : Display the video signal output screen background in monochrome.
UC = 1 : Display the video signal output screen background in color.
- UG, UR, UB : Screen background color

11. Command 11 (Sub-Screen Control)

[Command format]

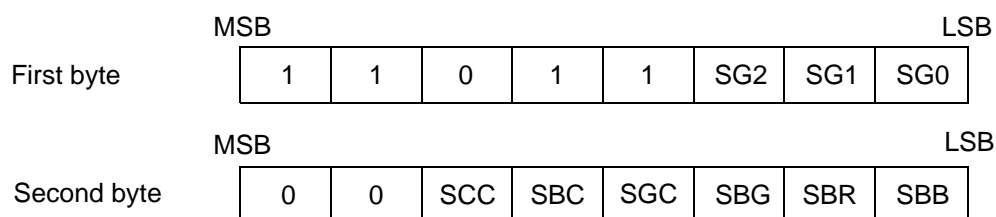

SG2 to SG0 : Sub-screen configuration control
 SCC : Sub-screen character color/monochrome control
 SBC : Sub-screen character background color/monochrome control
 SGC : Sub-screen graphic color/monochrome control
 SBG, SBR, SBB : Sub-screen pattern background color

[Function]

Command 11 controls sub-screen display.

[Description]

SG2 to SG0 : Sub-screen configuration control
 Specify the display configuration of the sub-screen.

SG2	SG1	SG0	Sub-screen configuration
0	0	0	1 character × 12 lines
0	0	1	2 characters × 12 lines
0	1	0	4 characters × 12 lines
0	1	1	8 characters × 12 lines
1	0	0	16 characters × 12 lines
1	0	1	24 characters × 12 lines
1	1	0	32 characters × 12 lines
1	1	1	Full-screen display mode (32 characters × 16 lines)

SCC : Sub-screen character color/monochrome control
 SCC = 0 : Display video signal output characters on the sub-screen in monochrome.
 SCC = 1 : Display video signal output characters on the sub-screen in color.

SBC : Sub-screen character background color/monochrome control
 SBC = 0 : Display the background of video signal output characters on the sub-screen in monochrome.
 SBC = 1 : Display the background of video signal output characters on the sub-screen in color.

SGC : Sub-screen graphic color/monochrome control
 SGC = 0 : Display video signal output graphic characters on the sub-screen in monochrome.
 SGC = 1 : Display video signal output graphic characters on the sub-screen in color.

SBG, SBR, SBB : Sub-screen background color

12. Command 12 (Sub-Screen Vertical Position Control)

[Command format]

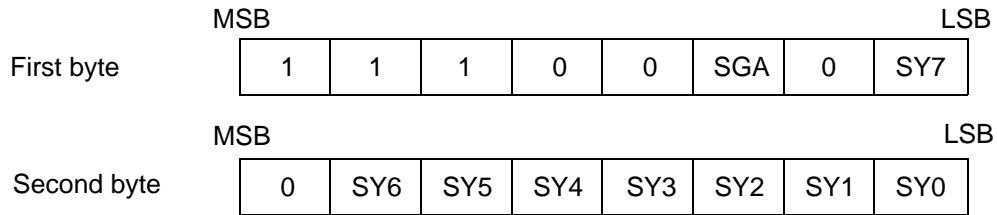

SGA : Sub-screen full-screen mode control
 SY7 to SY0 : Sub-screen vertical display position

[Description]

SGA : Sub-screen full-screen mode control
 Select a full-screen display mode for the sub-screen.
 SGA = 0 : Full-screen mode A
 Virtual screen : 32 characters × 16 lines × 32 screens
 (Display screen capacity : 32 characters × 16 lines)
 SGA = 1 : Full-screen mode B
 Virtual screen : 512 characters × 32 lines
 (Display screen capacity : 32 characters × 16 lines)

SY7 to SY0 : Sub-screen vertical display position (in 2-dot units)

13. Command 13 (Sub-Screen Horizontal Position Control)

[Command format]

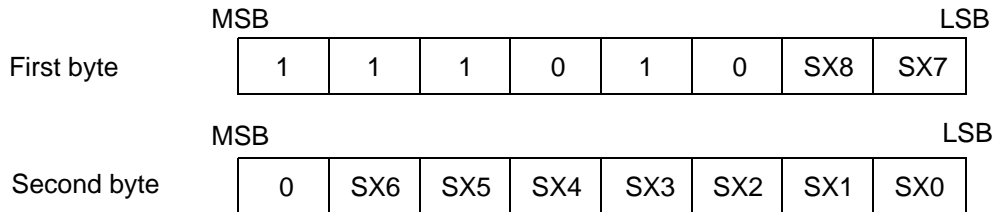

SX8 to SX0 : Sub-screen horizontal display position

[Description]

SX8 to SX0 : Sub-screen horizontal display position (in 2-dot units)

■ SCREEN CONFIGURATION

The MB90092 provides two screens: the main screen on which data can be set for each character and the sub-screen on which data can be set for each line (or for the entire screen). The overall background can be represented using the screen background color.

Figure 4 shows an example of main screen and sub-screen merged.

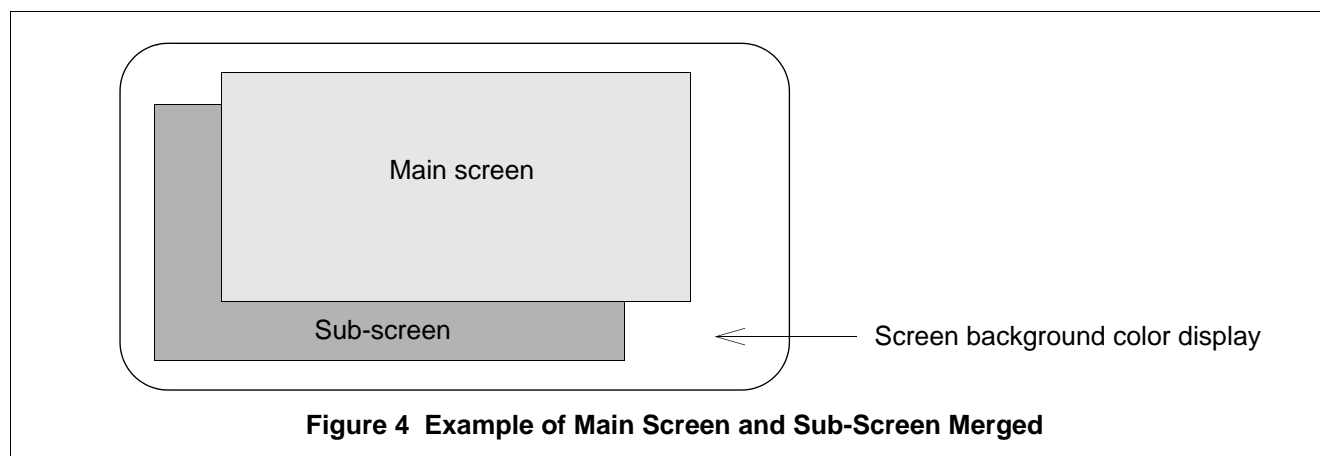

Figure 4 Example of Main Screen and Sub-Screen Merged

1. Main screen configuration

The main screen displays up to 24 characters by 12 lines. It offers a choice of two display modes: the normal mode for displaying only normal characters and the extended graphics mode in which both normal and graphic characters can be displayed, selectable character by character.

Main Screen Features

- Normal mode and extended graphics mode
- Screen configuration: 24 characters × 12 lines (data settable for each character)
- Character sizes: Five different types (selectable for each line)
- Line spacing: 0 to 15 rasters
- Display position control (Vertical: In raster units, Horizontal: In 1/3-character units)
- Setting display priority over the sub-screen (for each line)
- Output control (for each line)

2. Sub-screen configuration

The sub-screen offers a choice of two screen modes: the normal screen mode on which data can be set for each line and the full-screen mode A or B for full-screen display.

In the normal screen mode, the sub-screen displays up to 32 characters by 12 lines. The number of horizontal characters can range from 1 to 32 (1, 2, 4, 8, 16, 24, or 32 characters) depends on the SG2-SG0 setting of command 11 (sub-screen control).

Setting the code for the character to be displayed at the left end of each line allows a string of continuous characters of the same character code (address) to be displayed as many as the specified number of horizontal characters.

The full-screen mode enables display using the entire screen (screen display area: 32 characters × 16 lines). Setting the code for the character to be displayed at the upper left corner of the screen allows a string of continuous characters of the same character code to be displayed on the entire screen. Full-screen mode A or B is selected depending on the display area setting.

Sub-screen Features

- Normal screen mode/full-screen mode A/full-screen mode B
- Display position control (Vertical: In raster units, Horizontal: In 2-dot units)
- Setting display priority over the main screen (for each line on the main screen)
- Output control (for each line)

■ CHARACTER CONFIGURATION

1. Normal and Graphic Characters

The MB90092 can display two types of characters: normal characters and graphic characters.

Normal characters each consist of 24 horizontal dots × 32 vertical dots. Graphic characters each consists of 8 horizontal dots × 32 vertical dots. The normal and graphic characters are the same in size (3 horizontal dots for normal characters equal to one horizontal dot for graphic characters). The display color can be set for each dot of only graphic characters.

Figure 5 shows character configuration examples.

(1) Normal character configuration example:

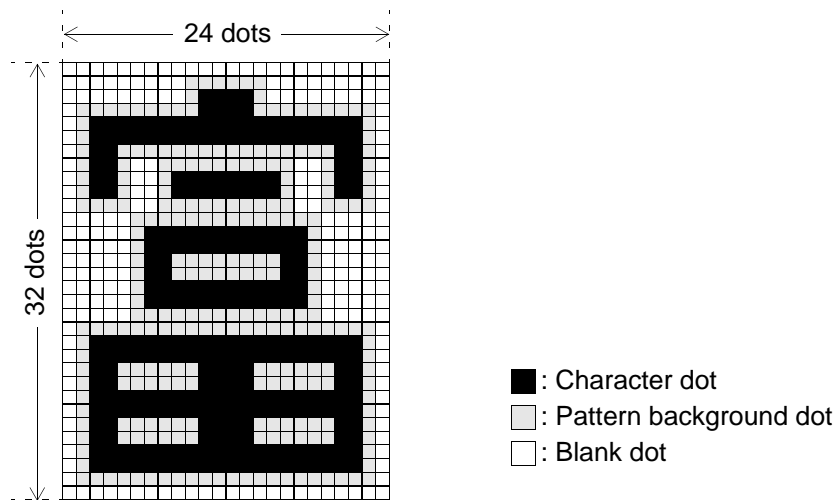

(2) Graphic character configuration example:

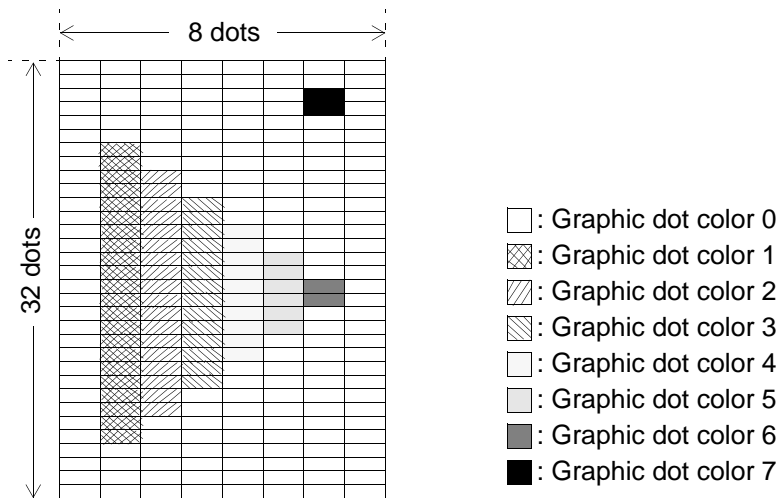

Figure 5 Character Configuration Examples

2. Character Sizes

Five different character sizes are available: standard, double width, double height, double width × double height, and double height × quadruple width. The character size can be specified for only the main screen. The sub-screen can display only the standard size of characters.

Figure 6 shows character configuration examples of each character size.

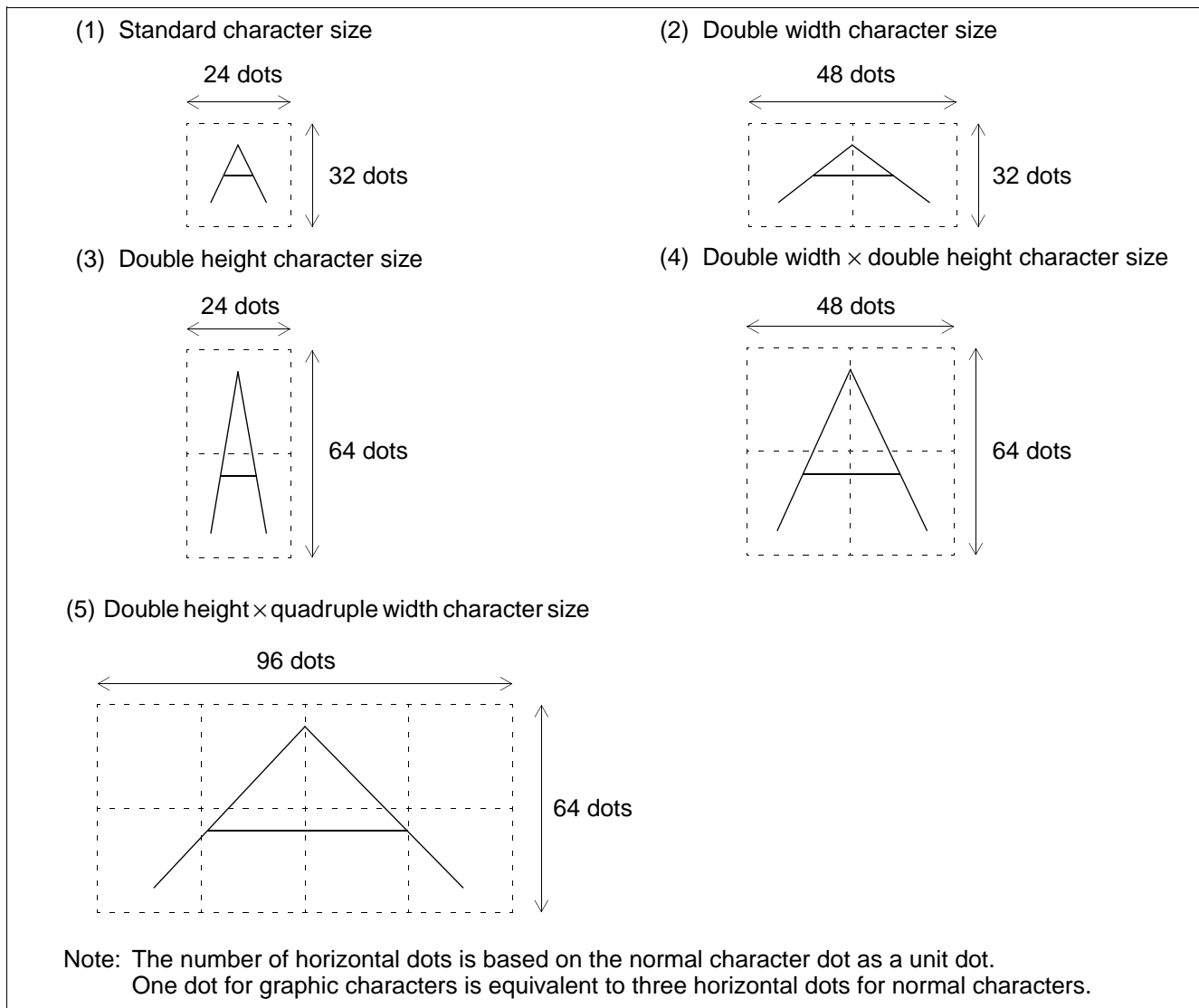

Figure 6 Zoom-in display function

2. Zoom-in display function

The zoom-in display function displays each character on the main screen using 48 vertical dots by vertically doubling only the upper 24 dots of font data which is 32 dots in height.

Characters enlarged by the zoom-in function can be further enlarged by separately specifying the desired character size.

■ CHARACTER DISPLAY FUNCTIONS

The character display functions available in the normal character display mode of the MB90092 include: “pattern background display” for displaying arbitrarily shaped patterns around character dots, “solid-fill background display” for filling the entire character cell made up of 24×32 dots with a background color, “shaded background display” for adding 3D shading to the perimeter of the solid-fill background, and “blink display” for blinking.

The MB90092 also provides “kanji font display” functions for framing and boldfacing of kanji fonts (such as the kanji ROM font) for easier viewing.

■ GRAPHIC CHARACTER DISPLAY FUNCTIONS

The MB90092 can display graphic characters as well as normal characters. Graphic characters consist of 8×32 dots each of which can be displayed in the color selected from among eight different colors. Color display information is included in font data. The character size is the same as that of normal characters. (One dot for graphic characters is equivalent to three dots for normal characters.)

Graphic character display has the following features:

- Dot configuration : 8×32 dots (horizontal \times vertical)
- Main screen display
- Display control : Normal and graphic characters selected for each character can be displayed at the same time. (Mixed display enabled only in extended graphics mode)
- Display character color : 8 colors (for each dot) \times 4 phases (for each character) or 8 gradient colors (color or monochrome specified for the entire screen)
- Sub-screen display
- Display control : Normal and graphic characters selected for each line can be displayed at the same time. (Mixed display enabled only in extended graphics mode)
- Display character color : 8 colors (for each dot) \times 4 phases (for each line) or 8 gradient colors (color or monochrome specified for the entire screen)

Note: Do not specify graphic display for those characters in the kanji font area. Otherwise, they cannot be displayed correctly.

■ ORDERING INFORMATION

Part number	Package	Remarks
MB90092PF	64-pin, plastic QFP (QFP-80P-M06)	

MB90092

■ PACKAGE DIMENSION

80-pin Plastic QFP
(FPT-80P-M06)

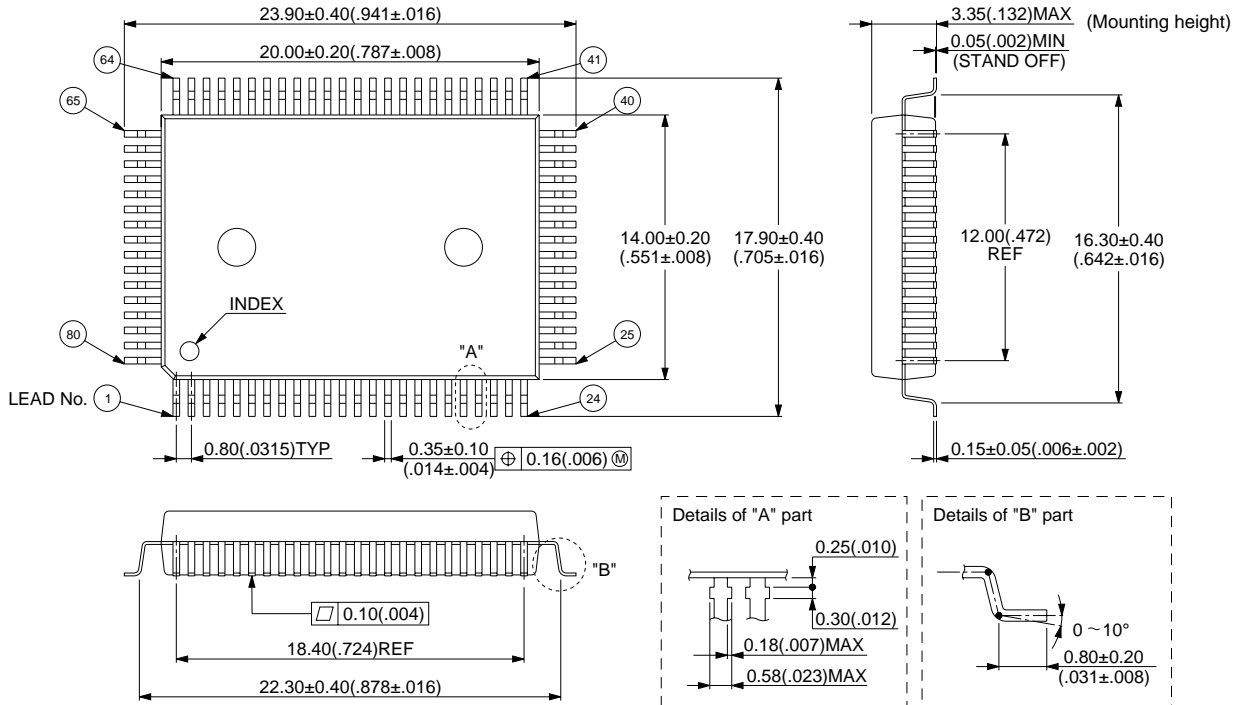

© 1994 FUJITSU LIMITED F80010S-3C-2

Dimensions in mm (inches)

FUJITSU LIMITED

For further information please contact:

Japan

FUJITSU LIMITED
Corporate Global Business Support Division
Electronic Devices
KAWASAKI PLANT, 4-1-1, Kamikodanaka
Nakahara-ku, Kawasaki-shi
Kanagawa 211-88, Japan
Tel: (044) 754-3763
Fax: (044) 754-3329

North and South America

FUJITSU MICROELECTRONICS, INC.
Semiconductor Division
3545 North First Street
San Jose, CA 95134-1804, U.S.A.
Tel: (408) 922-9000
Fax: (408) 432-9044/9045

Europe

FUJITSU MIKROELEKTRONIK GmbH
Am Siebenstein 6-10
63303 Dreieich-Buchsschlag
Germany
Tel: (06103) 690-0
Fax: (06103) 690-122

Asia Pacific

FUJITSU MICROELECTRONICS ASIA PTE. LIMITED
#05-08, 151 Lorong Chuan
New Tech Park
Singapore 556741
Tel: (65) 281-0770
Fax: (65) 281-0220

F9707

© FUJITSU LIMITED Printed in Japan

All Rights Reserved.

The contents of this document are subject to change without notice. Customers are advised to consult with FUJITSU sales representatives before ordering.

The information and circuit diagrams in this document presented as examples of semiconductor device applications, and are not intended to be incorporated in devices for actual use. Also, FUJITSU is unable to assume responsibility for infringement of any patent rights or other rights of third parties arising from the use of this information or circuit diagrams.

FUJITSU semiconductor devices are intended for use in standard applications (computers, office automation and other office equipment, industrial, communications, and measurement equipment, personal or household devices, etc.).

CAUTION:

Customers considering the use of our products in special applications where failure or abnormal operation may directly affect human lives or cause physical injury or property damage, or where extremely high levels of reliability are demanded (such as aerospace systems, atomic energy controls, sea floor repeaters, vehicle operating controls, medical devices for life support, etc.) are requested to consult with FUJITSU sales representatives before such use. The company will not be responsible for damages arising from such use without prior approval.

Any semiconductor devices have inherently a certain rate of failure. You must protect against injury, damage or loss from such failures by incorporating safety design measures into your facility and equipment such as redundancy, fire protection, and prevention of over-current levels and other abnormal operating conditions.

If any products described in this document represent goods or technologies subject to certain restrictions on export under the Foreign Exchange and Foreign Trade Control Law of Japan, the prior authorization by Japanese government should be required for export of those products from Japan.