

### General Description

This IGBT is produced using advanced Magnachip's Field Stop Trench IGBT Technology, which provides low  $V_{CE(SAT)}$ , high switching performance and excellent quality.

This device is for PFC, UPS & Inverter applications.

### Applications

- PFC
- UPS
- Inverter

### Features

- High Speed Switching & Low Power Loss
- $V_{CE(sat)} = 2.0V @ I_c = 40A$
- High Input Impedance
- $t_{rr} = 100ns$  (typ.)
- Ultra Soft, fast recovery anti-parallel diode
- Ultra narrowed VF distribution control
- Positive Temperature coefficient for easy paralleling

TO-247

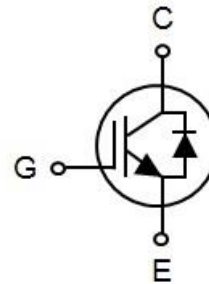
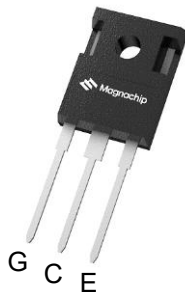

### Absolute Maximum Ratings

Characteristics		Symbol	Rating	Unit
Collector-emitter voltage		$V_{CES}$	1200	V
Gate-emitter voltage		$V_{GES}$	$\pm 20$	V
Collector current	$T_C = 25^\circ C$	$I_C$	80	A
	$T_C = 100^\circ C$		40	A
Pulsed collector current, pulse time limited by $T_{jmax}$		$I_{CM}$	160	A
Diode forward current @ $T_C = 100^\circ C$		$I_F$	40	A
Diode pulsed current, Pulse time limited by $T_{jmax}$		$I_{FM}$	160	A
Power dissipation	$T_C = 25^\circ C$	$P_D$	357	W
	$T_C = 100^\circ C$		142	W
Short circuit withstand time $V_{CE} = 600V, V_{GE} = 15V, T_C = 150^\circ C$		tsc	10	$\mu s$
Operating Junction and storage temperature range		$T_J, T_{stg}$	-55~150	$^\circ C$

### Thermal Characteristics

Characteristics	Symbol	Rating	Unit
Thermal resistance junction-to-ambient	$R_{\theta JA}$	40	$^\circ C/W$
Thermal resistance junction-to-case for IGBT	$R_{\theta JC}$	0.35	
Thermal resistance junction-to-case for Diode	$R_{\theta JC}$	0.8	

### Ordering Information

Part Number	Marking	Temp. Range	Package	Packing	RoHS Status
MBQ40T120FESTH	40T120FES	-55~150°C	TO-247	Tube	Pb Free

### Electrical Characteristics (Tc =25°C unless otherwise specified)

Characteristics	Symbol	Test Condition	Min	Typ	Max	Unit	
<b>Static Characteristics</b>							
Collector-emitter breakdown voltage	$BV_{CES}$	$I_C = 1mA, V_{GE} = 0V$	1200	-	-	V	
Gate-emitter threshold voltage	$V_{GE(th)}$	$V_{CE} = V_{GE}, I_C = 1mA$	4.5	5.5	6.5	V	
Zero gate voltage collector current	$I_{CES}$	$V_{CE} = 1200V, V_{GE} = 0V$	-	-	1	mA	
Gate-emitter leakage current	$I_{GES}$	$V_{GE} = 20V, V_{CE} = 0V$	-	-	±250	nA	
Collector-emitter saturation voltage	$V_{CE(sat)}$	$I_C = 40A, V_{GE} = 15V, T_C = 25°C$	-	2.0	2.4	V	
		$I_C = 40A, V_{GE} = 15V, T_C = 150°C$	-	2.45	-		
<b>Dynamic and Switching Characteristics</b>							
Total gate charge	$Q_g$	$V_{CE} = 600V, I_C = 40A, V_{GE} = 15V$	-	341	-	nC	
Gate-emitter charge	$Q_{ge}$		-	52	-		
Gate-collector charge	$Q_{gc}$		-	126	-		
Input capacitance	$C_{ies}$	$V_{CE} = 30V, V_{GE} = 0V, f = 1MHz$	-	6030	-	pF	
Reverse transfer capacitance	$C_{res}$		-	107	-		
Output capacitance	$C_{oes}$		-	206	-		
Turn-on delay time	$t_{d(on)}$	$V_{GE} = 15V, V_{CC} = 600V, I_C = 40A, R_G = 10Ω, Inductive Load, T_C = 25°C$	-	65	-	ns	
Rise time	$t_r$		-	55	-		
Turn-off delay time	$t_{d(off)}$		-	308	-		
Fall time	$t_f$		-	40	-		
Turn-on switching energy	$E_{on}$		$V_{GE} = 15V, V_{CC} = 600V, I_C = 40A, R_G = 10Ω, Inductive Load, T_C = 150°C$	-	1.96	-	mJ
Turn-off switching energy	$E_{off}$			-	0.54	-	
Total switching energy	$E_{ts}$			-	2.50	-	
Turn-on delay time	$t_{d(on)}$			-	70	-	ns
Rise time	$t_r$			-	62	-	
Turn-off delay time	$t_{d(off)}$			-	325	-	
Fall time	$t_f$	-	62	-			
Turn-on switching energy	$E_{on}$	$V_{GE} = 15V, V_{CC} = 600V, I_C = 40A, R_G = 10Ω, Inductive Load, T_C = 150°C$	-	2.35	-	mJ	
Turn-off switching energy	$E_{off}$		-	1.61	-		
Total switching energy	$E_{ts}$		-	3.96	-		

### Diode Characteristics (Tc =25°C unless otherwise specified)

Forward voltage	$V_F$	$I_F = 40A, T_C = 25°C$	-	2.4	3.0	V
		$I_F = 40A, T_C = 150°C$	-	2.45	-	
Reverse recovery time	$t_{rr}$	$I_F = 40A, di/dt = 200A/μs, T_C = 25°C$	-	100	-	ns
Reverse recovery current	$I_{rr}$		-	7	-	A
Reverse recovery charge	$Q_{rr}$		-	350	-	nC
Reverse recovery time	$t_{rr}$	$I_F = 40A, di/dt = 200A/μs, T_C = 150°C$	-	180	-	ns
Reverse recovery current	$I_{rr}$		-	10	-	A
Reverse recovery charge	$Q_{rr}$		-	900	-	nC

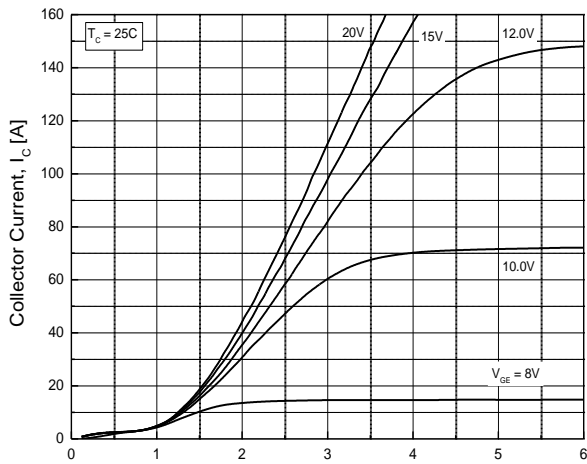

**Fig.1 Typical Output Characteristics**

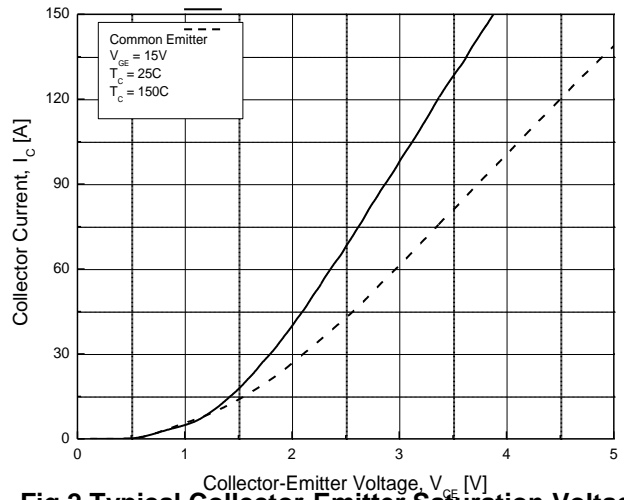

**Fig.2 Typical Collector-Emitter Saturation Voltage**

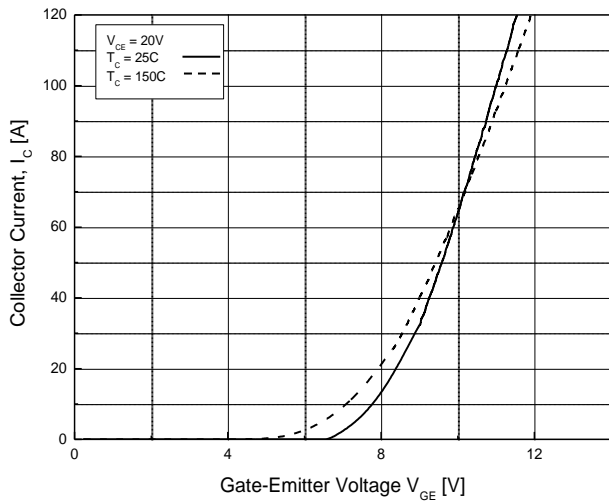

**Fig.3 Typical Transfer Characteristics**

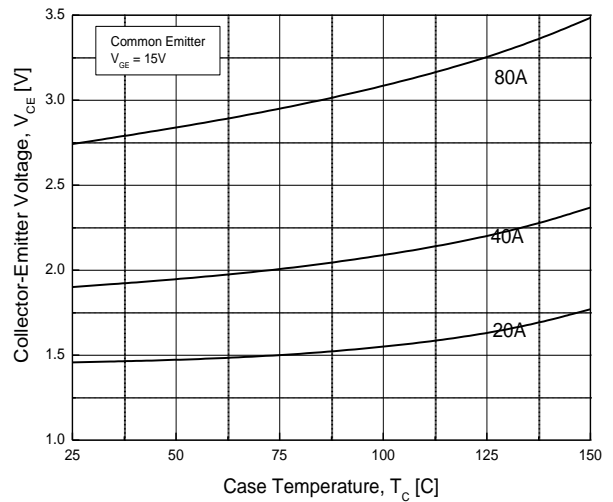

**Fig.4 Typical Collector-Emitter Saturation Voltage at Case Temperature**

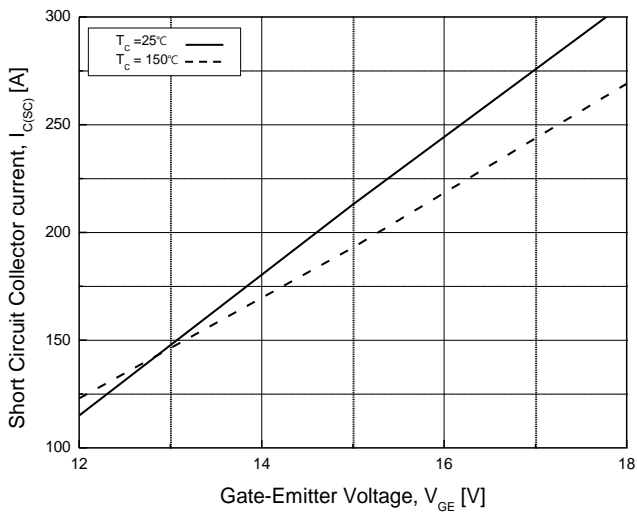

**Fig.5 Typical Short Circuit Collector Current**

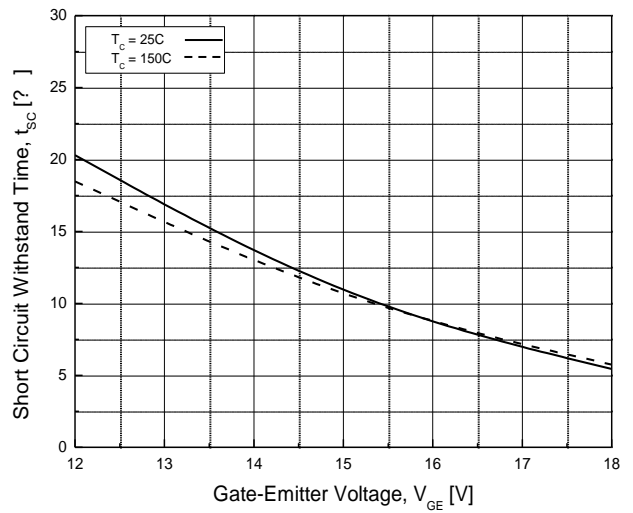

**Fig.6 Typical Short Circuit Withstand Time**

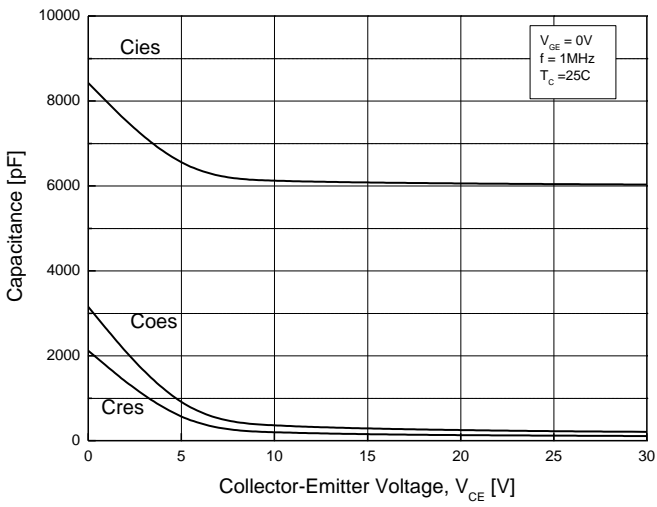

**Fig.7 Typical Capacitance**

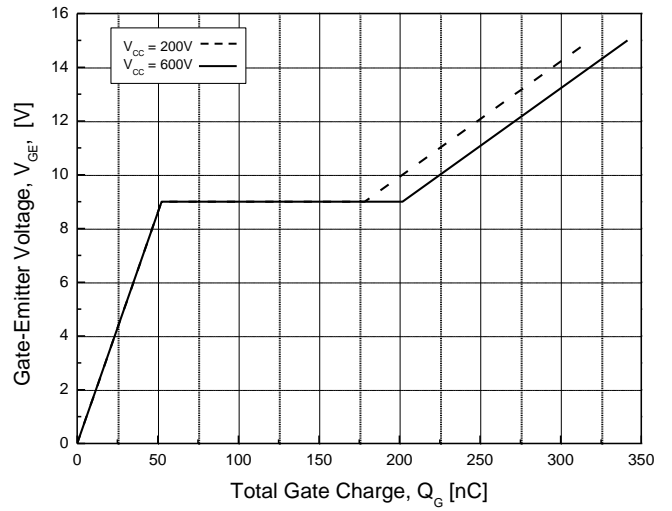

**Fig.8 Typical Gate Charge**

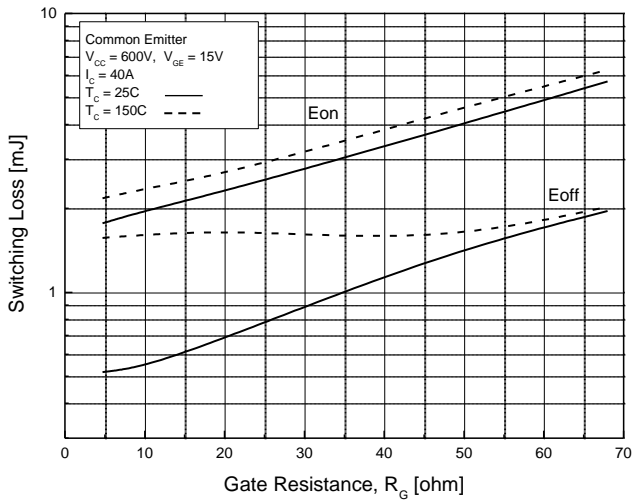

**Fig.9 Switching Loss-Gate Resistance**

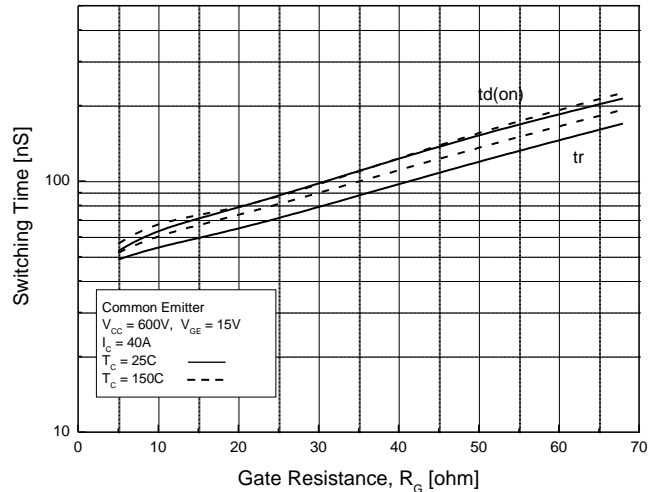

**Fig.10 Turn on Characteristics-Gate Resistance**

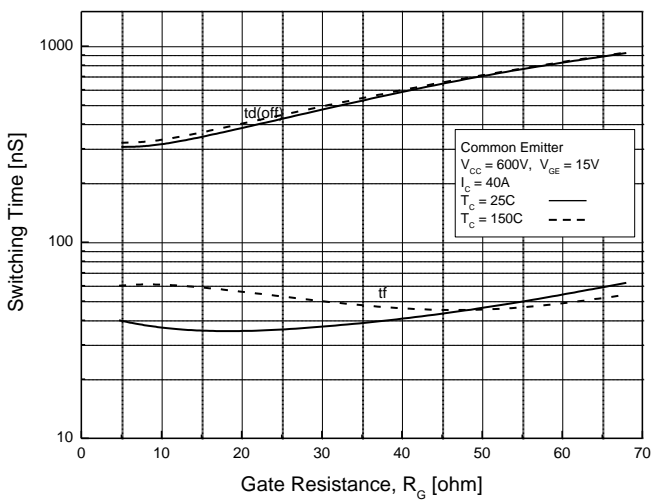

**Fig.11 Turn off Characteristics-Gate Resistance**

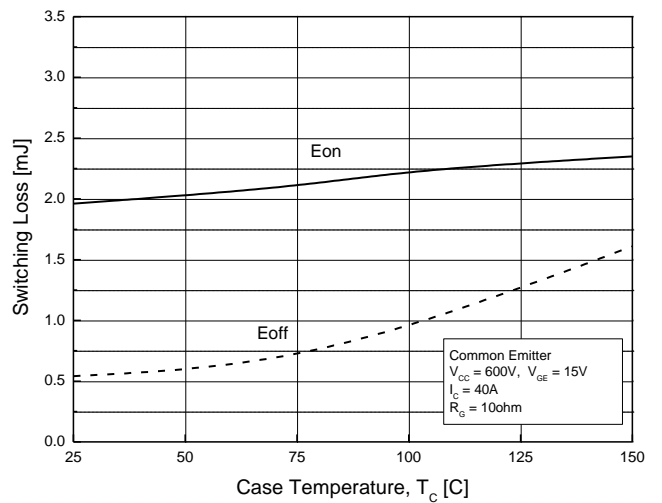

**Fig.12 Switching Loss-Case Temperature**

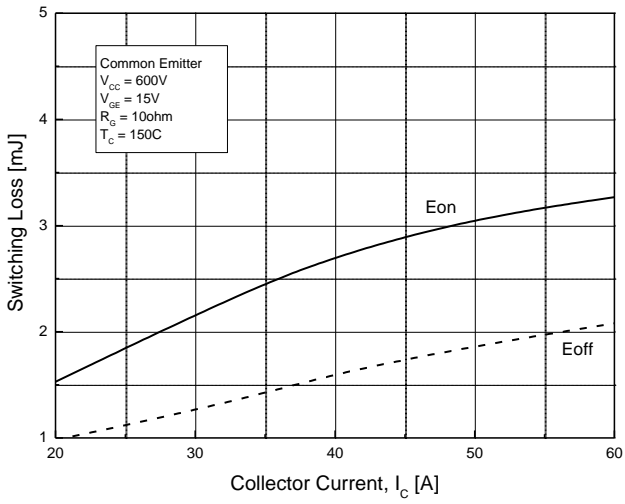

**Fig.13 Switching Loss-Collector Current**

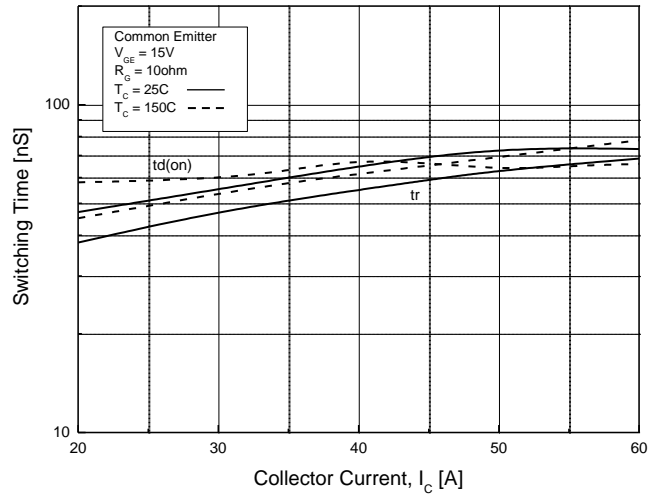

**Fig.14 Typical Turn on-Collector Current**

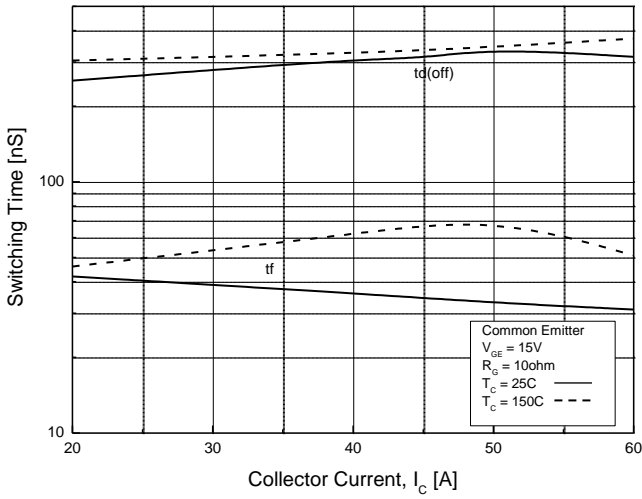

**Fig.15 Typical Turn off-Collector Current**

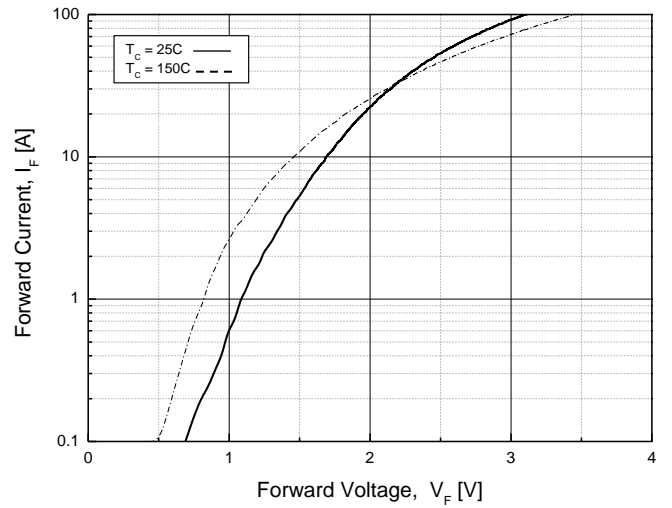

**Fig.16 Diode Forward Characteristics**

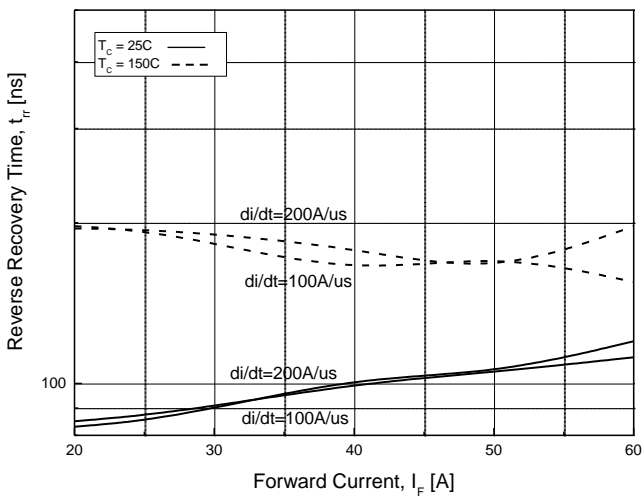

**Fig.17 Typical Turn off-Collector Current**

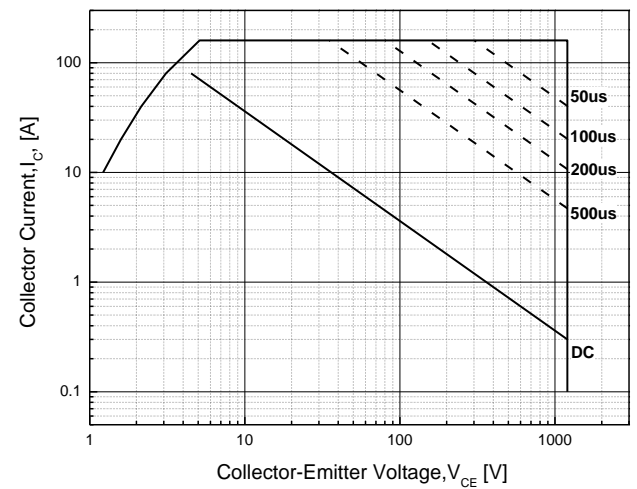

**Fig.18 Forward Bias Safe Operating Area**

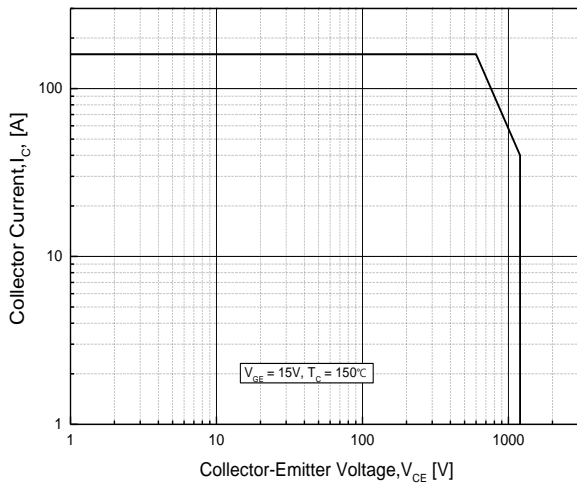

**Fig.19 Reverse Bias Safe Operating Area**

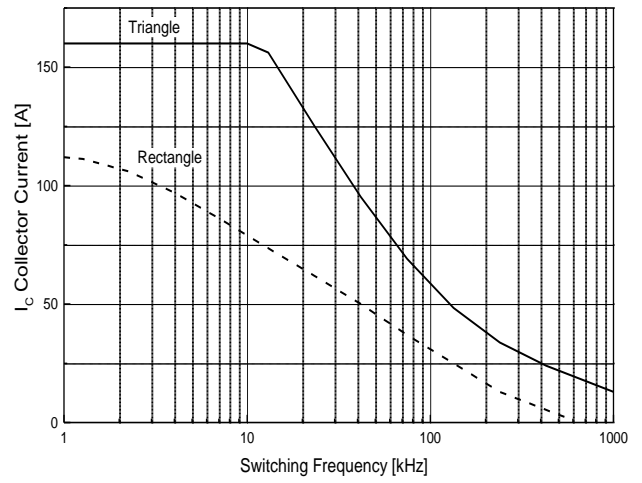

**Fig.20 Switching frequency – Collector current**

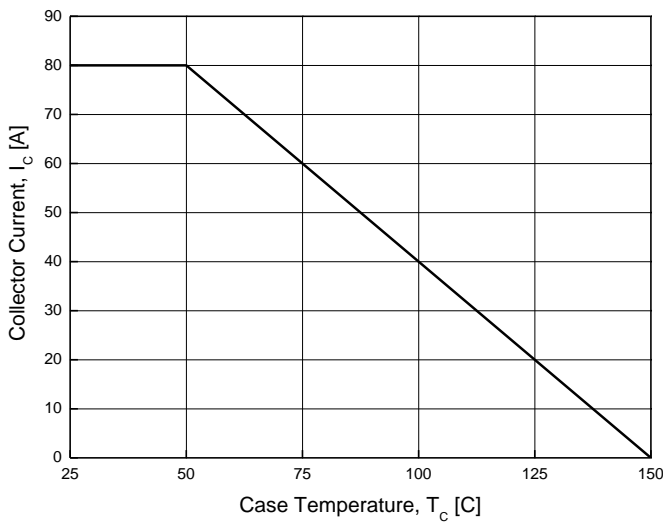

**Fig.21 Case Temperature – Collector Current**

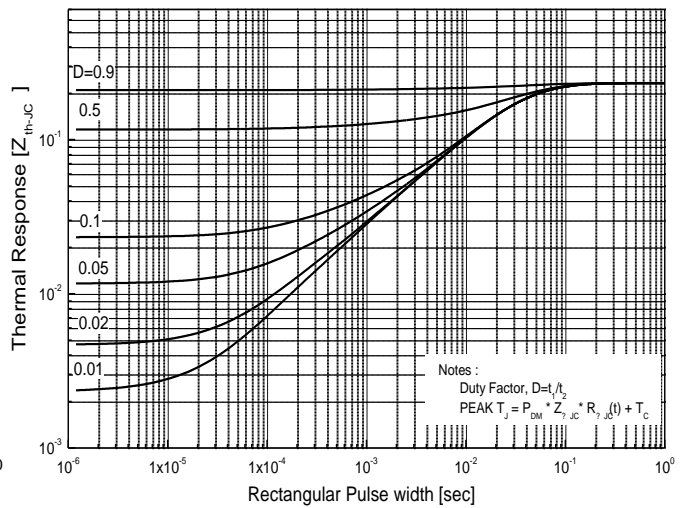
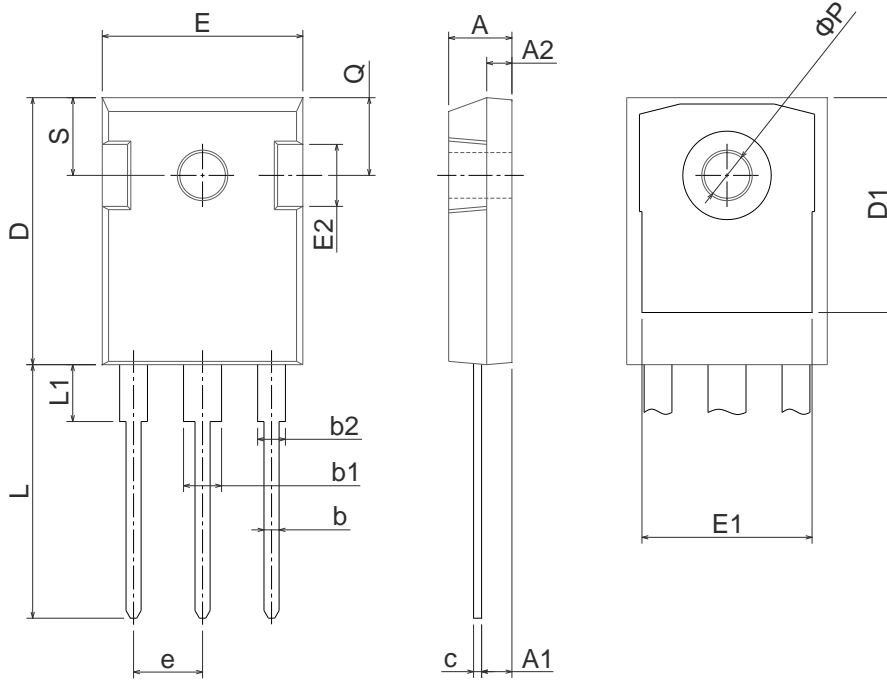

**Fig.22 IGBT Transient Thermal Impedance**

**Physical Dimension**

**TO-247**

Dimensions are in millimeters, unless otherwise specified



Dimension	Min(mm)	Max(mm)
A	4.70	5.31
A1	2.20	2.60
A2	1.50	2.49
b	0.99	1.40
b1	2.59	3.43
b2	1.65	2.39
c	0.38	0.89
D	20.30	21.46
D1	13.08	-
E	15.45	16.26
E1	13.06	14.02
E2	4.32	5.49
e	5.45BSC	
L	19.81	20.57
L1	-	4.50
ΦP	3.50	3.70
Q	5.38	6.20
S	6.15BSC	

Note : Package body size, length and width do not include mold flash, protrusions and gate burrs.

**DISCLAIMER:**

The Products are not designed for use in hostile environments, including, without limitation, aircraft, nuclear power generation, medical appliances, and devices or systems in which malfunction of any Product can reasonably be expected to result in a personal injury. Seller's customers using or selling Seller's products for use in such applications do so at their own risk and agree to fully defend and indemnify Seller.

Magnachip reserves the right to change the specifications and circuitry without notice at any time. Magnachip does not consider responsibility for use of any circuitry other than circuitry entirely included in a Magnachip product.  Magnachip is a registered trademark of Magnachip Semiconductor Ltd.