

MBR0520L

Surface Mount Schottky Barrier Diode

Features

- Very low forward voltage

PINNING

PIN	DESCRIPTION
1	Cathode
2	Anode

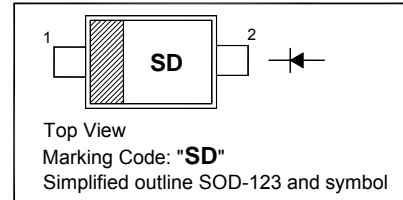

Absolute Maximum Ratings ($T_a = 25\text{ }^\circ\text{C}$)

Parameter	Symbol	Value	Unit
Maximum Repetitive Reverse Voltage	V_R	20	V
Average Rectified Forward Current	$I_{F(AV)}$	0.5	A
Non-Repetitive Peak Forward Current (Surge Applied at Rated Load Conditions Halfwave, Single Phase, 60 Hz)	I_{FSM}	5.5	A
Thermal Resistance Junction to Lead	$R_{\theta JL}$	150	$^\circ\text{C/W}$
Thermal Resistance Junction to Ambient ¹⁾	$R_{\theta JA}$	340	$^\circ\text{C/W}$
Operating Junction Temperature Range	T_j	- 65 to + 125	$^\circ\text{C}$
Storage Temperature Range	T_{stg}	- 65 to + 150	$^\circ\text{C}$

¹⁾ FR-4 or FR-5 = 3.5 X 1.5 inches using minimum recommended land pads.

Characteristics ($T_a = 25\text{ }^\circ\text{C}$)

Parameter	Symbol	Max.	Unit
Forward Voltage at $I_F = 0.1\text{ A}$ at $I_F = 0.5\text{ A}$ at $I_F = 0.1\text{ A}, T_a = 100\text{ }^\circ\text{C}$ at $I_F = 0.5\text{ A}, T_a = 100\text{ }^\circ\text{C}$	V_F	0.3 0.385 0.22 0.33	V
Reverse Current at $V_R = 10\text{ V}$ at $V_R = 20\text{ V}$ at $V_R = 10\text{ V}, T_a = 100\text{ }^\circ\text{C}$ at $V_R = 20\text{ V}, T_a = 100\text{ }^\circ\text{C}$	I_R	75 250 5 8	μA μA mA mA

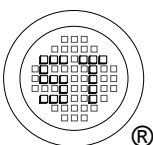

SEMTECH ELECTRONICS LTD.
Subsidiary of Sino-Tech International (BVI) Limited



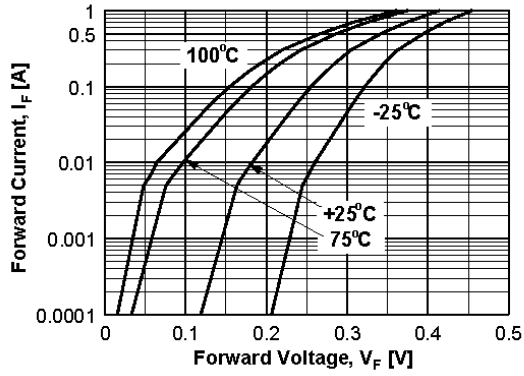

Figure 1. Forward Voltage Characteristics

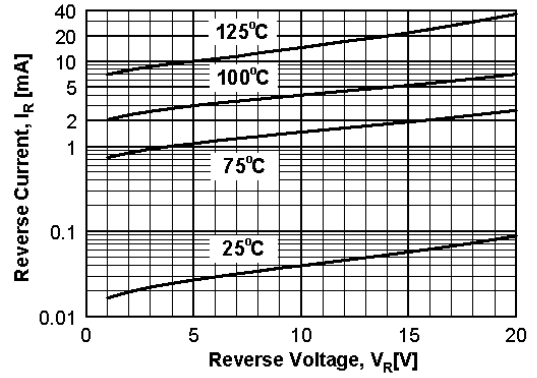

Figure 2. Reverse Current vs Reverse Voltage

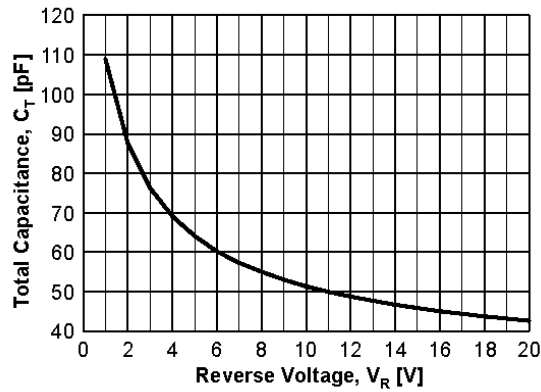
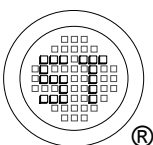

Figure 3. Total Capacitance



SEMTECH ELECTRONICS LTD.
Subsidiary of Sino-Tech International (BVI) Limited



MBR0520L

PACKAGE OUTLINE

Plastic surface mounted package; 2 leads

SOD-123

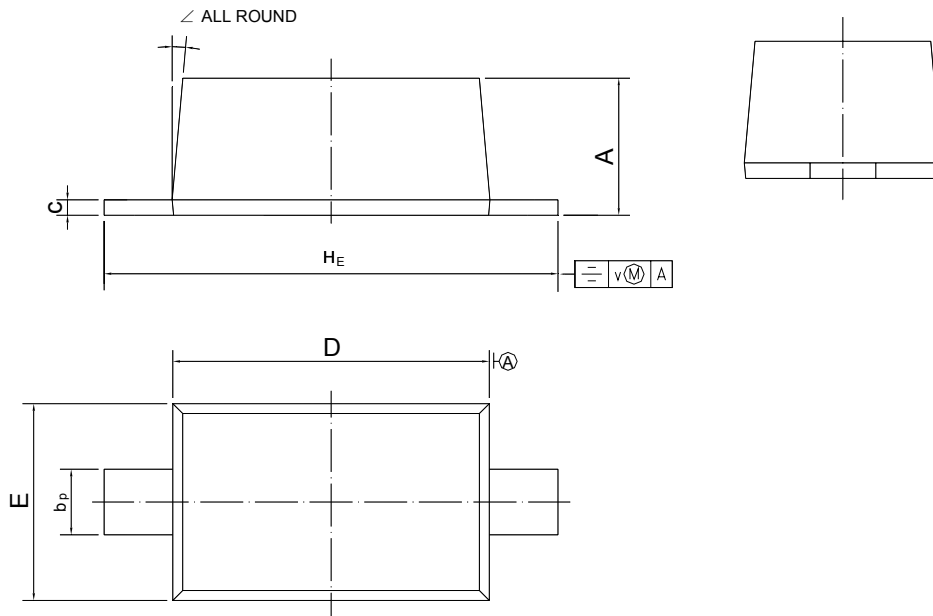

UNIT	A	b _p	c	D	E	H _E	v	∠
mm	1.15 1.05	0.6 0.5	0.135 0.100	2.7 2.6	1.65 1.55	3.85 3.55	0.2	5°

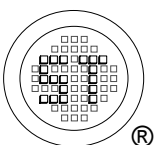

SEMTECH ELECTRONICS LTD.
Subsidiary of Sino-Tech International (BVI) Limited



Dated : 27/09/2010 Rev:01