

High-Voltage Schottky Rectifier

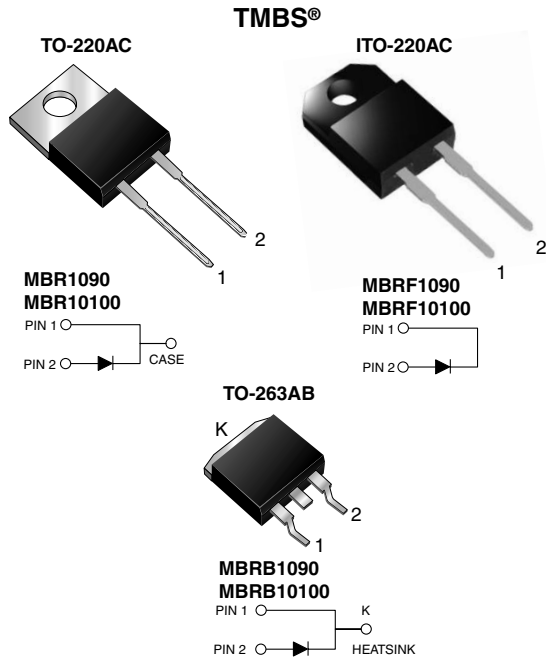

FEATURES

- Trench MOS Schottky technology
- Lower power losses, high efficiency
- Low forward voltage drop
- High forward surge capability
- High frequency operation
- Meets MSL level 1, per J-STD-020C, LF max peak of 245 °C (for TO-263AB package)
- Solder dip 260 °C, 40 seconds (for TO-220AC and ITO-220AC package)
- Component in accordance to RoHS 2002/95/EC and WEEE 2002/96/EC



TYPICAL APPLICATIONS

For use in high frequency rectifier of switching mode power supplies, free-wheeling diodes, dc-to-dc converters or polarity protection application.

MECHANICAL DATA

Case: TO-220AC, ITO-220AC, TO-263AB

Epoxy meets UL 94V-0 flammability rating

Terminals: Matte tin plated leads, solderable per J-STD-002B and JESD22-B102D

E3 suffix for commercial grade

Polarity: As marked

Mounting Torque: 10 in-lbs maximum

PRIMARY CHARACTERISTICS

$I_{F(AV)}$	10 A
V_{RRM}	90 V, 100 V
I_{FSM}	150 A
V_F	0.65 V
$T_J \text{ max.}$	150 °C

MAXIMUM RATINGS ($T_C = 25\text{ °C}$ unless otherwise noted)

PARAMETER	SYMBOL	MBR1090	MBR10100	UNIT
Maximum repetitive peak reverse voltage	V_{RRM}	90	100	V
Working peak reverse voltage	V_{RWM}	90	100	V
Maximum DC blocking voltage	V_{DC}	90	100	V
Maximum average forward rectified current at $T_C = 133\text{ °C}$	$I_{F(AV)}$	10		A
Peak forward surge current 8.3 ms single half sine-wave superimposed on rated load	I_{FSM}	150		A
Peak repetitive reverse current at $t_p = 2\ \mu\text{s}$, 1 kHz	I_{RRM}	0.5		A
Voltage rate of change (rated V_R)	dv/dt	10000		V/ μs
Operating junction and storage temperature range	T_J, T_{STG}	- 65 to + 150		°C
Isolation voltage (ITO-220AC only) From terminal to heatsink $t = 1$ minute	V_{AC}	1500		V



ELECTRICAL CHARACTERISTICS ($T_C = 25\text{ }^\circ\text{C}$ unless otherwise noted)				
PARAMETER	TEST CONDITIONS	SYMBOL	VALUE	UNIT
Maximum instantaneous forward voltage ⁽¹⁾	$I_F = 10\text{ A}$, $T_C = 25\text{ }^\circ\text{C}$	V_F	0.80	V
	$I_F = 10\text{ A}$, $T_C = 125\text{ }^\circ\text{C}$		0.65	
	$I_F = 20\text{ A}$, $T_C = 125\text{ }^\circ\text{C}$		0.75	
Maximum reverse current at working peak reverse voltage ⁽¹⁾	$T_J = 25\text{ }^\circ\text{C}$	I_R	100	μA
	$T_J = 100\text{ }^\circ\text{C}$		6.0	

Note:

(1) Pulse test: 300 μs pulse width, 1 % duty cycle

THERMAL CHARACTERISTICS ($T_C = 25\text{ }^\circ\text{C}$ unless otherwise noted)					
PARAMETER	SYMBOL	MBR	MBRF	MBRB	UNIT
Typical thermal resistance	$R_{\theta JA}$	60	-	60	$^\circ\text{C/W}$
	$R_{\theta JC}$	2.0	3.5	2.0	

ORDERING INFORMATION (Example)					
PACKAGE	PREFERRED P/N	UNIT WEIGHT (g)	PACKAGE CODE	BASE QUANTITY	DELIVERY MODE
TO-220AC	MBR10100-E3/4W	1.845	4W	50/Tube	Tube
ITO-220AC	MBRF10100-E3/4W	1.661	4W	50/Tube	Tube
TO-263AB	MBRB10100-E3/4W	1.384	4W	50/Tube	Tube
TO-263AB	MBRB10100-E3/8W	1.384	8W	800/Reel	Tape reel

RATINGS AND CHARACTERISTICS CURVES

($T_A = 25\text{ }^\circ\text{C}$ unless otherwise noted)

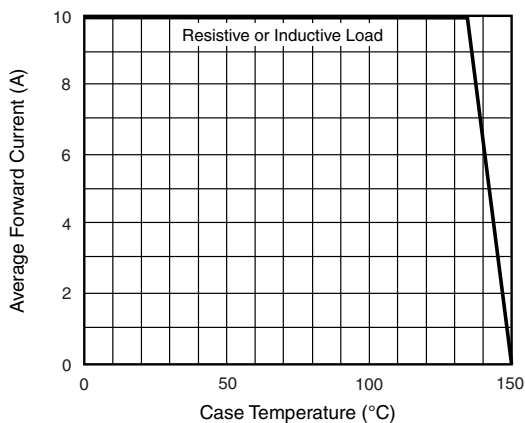

Figure 1. Forward Current Derating Curve

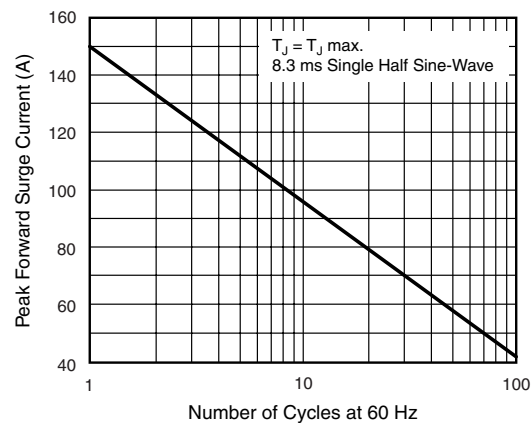

Figure 2. Maximum Non-Repetitive Peak Forward Surge Current

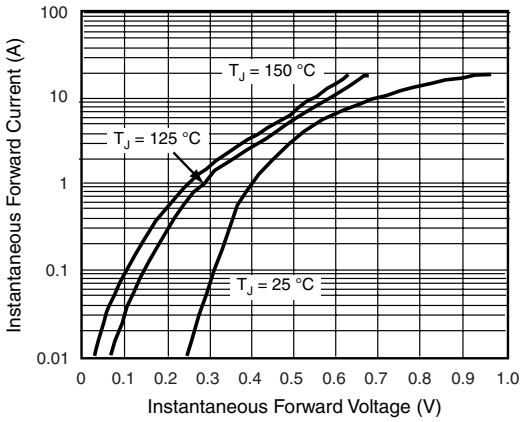

Figure 3. Typical Instantaneous Forward Characteristics

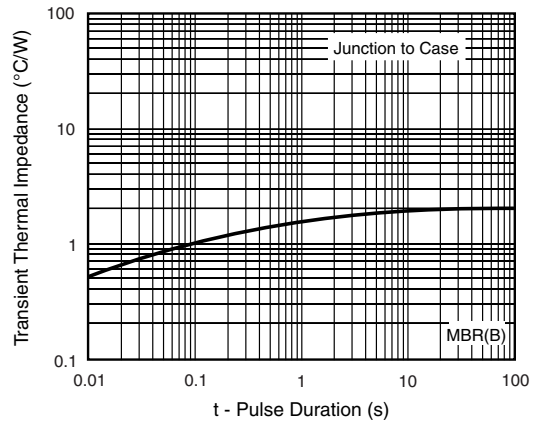

Figure 6. Typical Transient Thermal Impedance

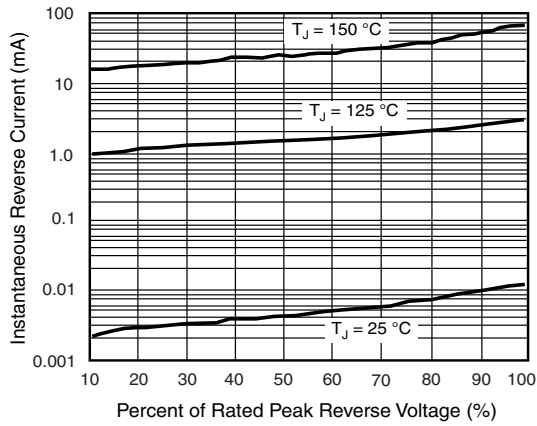

Figure 4. Typical Reverse Characteristics

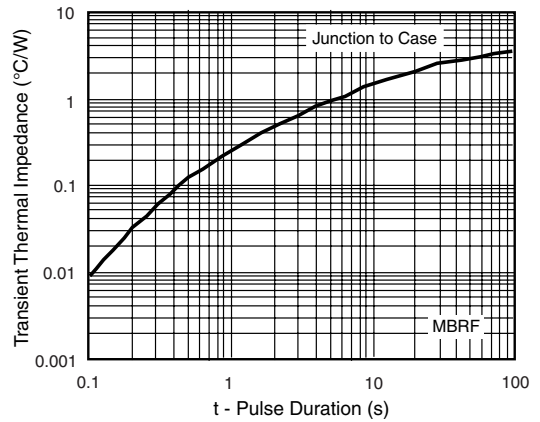

Figure 7. Typical Transient Thermal Impedance

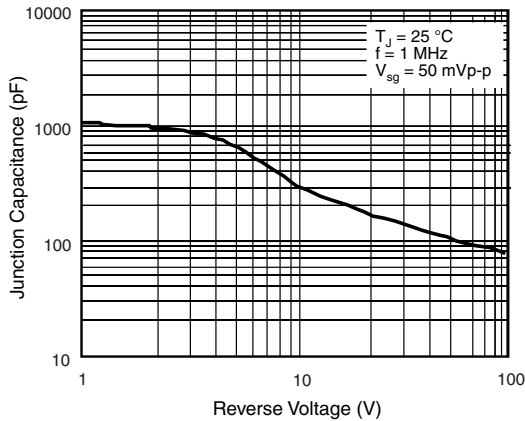

Figure 5. Typical Junction Capacitance

MBR(F,B)1090 & MBR(F,B)10100

Vishay General Semiconductor



PACKAGE OUTLINE DIMENSIONS in inches (millimeters)

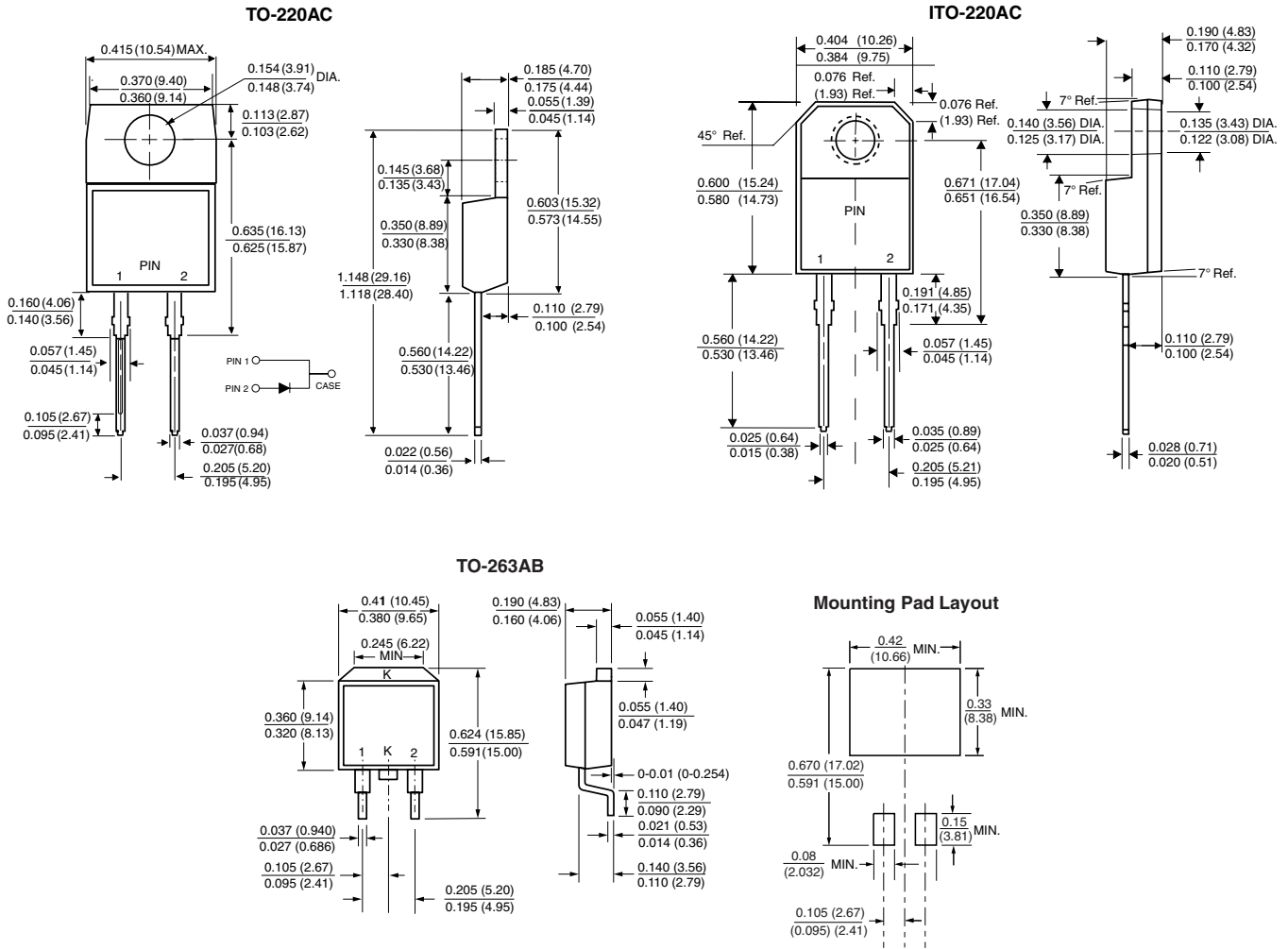



Notice

Specifications of the products displayed herein are subject to change without notice. Vishay Intertechnology, Inc., or anyone on its behalf, assumes no responsibility or liability for any errors or inaccuracies.

Information contained herein is intended to provide a product description only. No license, express or implied, by estoppel or otherwise, to any intellectual property rights is granted by this document. Except as provided in Vishay's terms and conditions of sale for such products, Vishay assumes no liability whatsoever, and disclaims any express or implied warranty, relating to sale and/or use of Vishay products including liability or warranties relating to fitness for a particular purpose, merchantability, or infringement of any patent, copyright, or other intellectual property right.

The products shown herein are not designed for use in medical, life-saving, or life-sustaining applications. Customers using or selling these products for use in such applications do so at their own risk and agree to fully indemnify Vishay for any damages resulting from such improper use or sale.