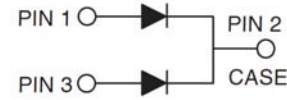

## Dual Common Cathode Schottky Rectifier

### FEATURES

- Low power loss, high efficiency
- Guardring for overvoltage protection
- High surge current capability
- Compliant to RoHS Directive 2011/65/EU and in accordance to WEEE 2002/96/EC
- Halogen-free according to IEC 61249-2-21 definition

**TO-220AB**

### MECHANICAL DATA

**Case:** TO-220AB

Molding compound, UL flammability classification rating 94V-0

Base P/N with suffix "G" on packing code - green compound (halogen-free)

**Terminal:** Matte tin plated leads, solderable per JESD22-B102

Meet JESD 201 class 1A whisker test

**Polarity:** As marked

**Mounting torque:** 5 in-lbs maximum

**Weight:** 1.9 g (approximately)

MAXIMUM RATINGS AND ELECTRICAL CHARACTERISTICS (T <sub>A</sub> =25°C unless otherwise noted)						
PARAMETER	SYMBOL	MBR 2545 CT-Y	MBR 2560 CT-Y	MBR 25100 CT-Y	MBR 25150 CT-Y	UNIT
Marking code		MBR25 45CT	MBR25 60CT	MBR25 100CT	MBR25 150CT	
Maximum repetitive peak reverse voltage	V <sub>RRM</sub>	45	60	100	150	V
Maximum RMS voltage	V <sub>RMS</sub>	31	42	70	105	V
Maximum DC blocking voltage	V <sub>DC</sub>	45	60	100	150	V
Maximum average forward rectified current	I <sub>F(AV)</sub>	25				A
Peak repetitive forward current (Rated VR, square wave, 20KHz)	I <sub>FRM</sub>	25				A
Peak forward surge current, 8.3 ms single half sine-wave superimposed on rated load	I <sub>FSM</sub>	200				A
Peak repetitive reverse surge current (Note 1)	I <sub>RRM</sub>	1	0.5			A
Maximum instantaneous forward voltage (Note 2) I <sub>F</sub> =12.5A, T <sub>J</sub> =25°C I <sub>F</sub> =12.5A, T <sub>J</sub> =125°C I <sub>F</sub> =25A, T <sub>J</sub> =25°C I <sub>F</sub> =25A, T <sub>J</sub> =125°C	V <sub>F</sub>	- - 0.82 0.73	0.75 0.65 - -	0.85 0.75 0.92 0.88	0.95 0.92 1.02 0.98	V
Maximum reverse current @ rated VR T <sub>J</sub> =25 °C T <sub>J</sub> =125 °C	I <sub>R</sub>	0.2 15	0.2 10	0.1 7.5	0.1 5	mA
Voltage rate of change (Rated V <sub>R</sub> )	dV/dt	10000				V/μs
Typical thermal resistance	R <sub>θJC</sub>	1				°C/W
Operating junction temperature range	T <sub>J</sub>	- 55 to +150				°C
Storage temperature range	T <sub>STG</sub>	- 55 to +150				°C

Note 1: t<sub>p</sub> = 2.0 μs, 1.0KHz

Note 2: Pulse test with PW=300μs, 1% duty cycle

ORDERING INFORMATION				
PART NO.	PACKING CODE	GREEN COMPOUND CODE	PACKAGE	PACKING
MBR25xxCT-Y (Note 1)	C0	Suffix "G"	TO-220AB	50 / Tube

Note 1: "xx" defines voltage from 45V (MBR2545CT-Y) to 150V (MBR25150CT-Y)

EXAMPLE				
PREFERRED P/N	PART NO.	PACKING CODE	GREEN COMPOUND CODE	DESCRIPTION
MBR2560CT-Y C0	MBR2560CT-Y	C0		
MBR2560CT-Y C0G	MBR2560CT-Y	C0	G	Green compound

**RATINGS AND CHARACTERISTICS CURVES**

(TA=25°C unless otherwise noted)

FIG. 1- FORWARD CURRENT DERATING CURVE

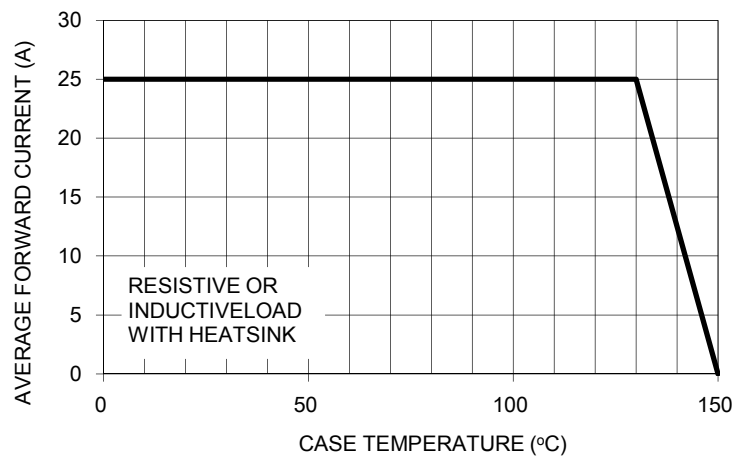

FIG. 2- MAXIMUM NON-REPETITIVE FORWARD SURGE CURRENT PER LEG

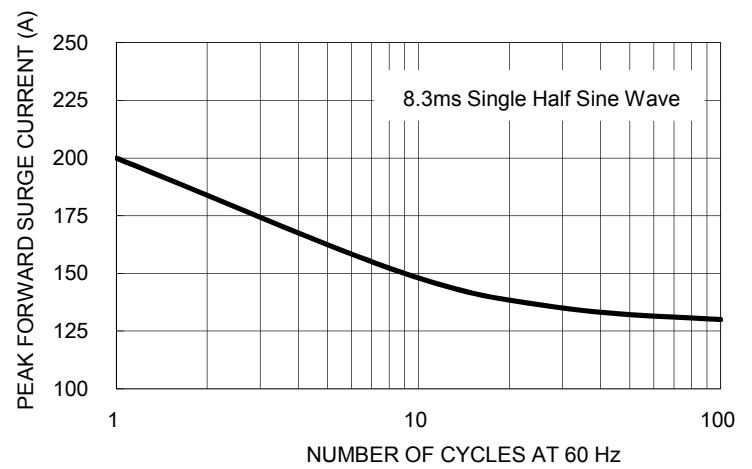

FIG. 3- TYPICAL INSTANTANEOUS FORWARD CHARACTERISTICS PER LEG

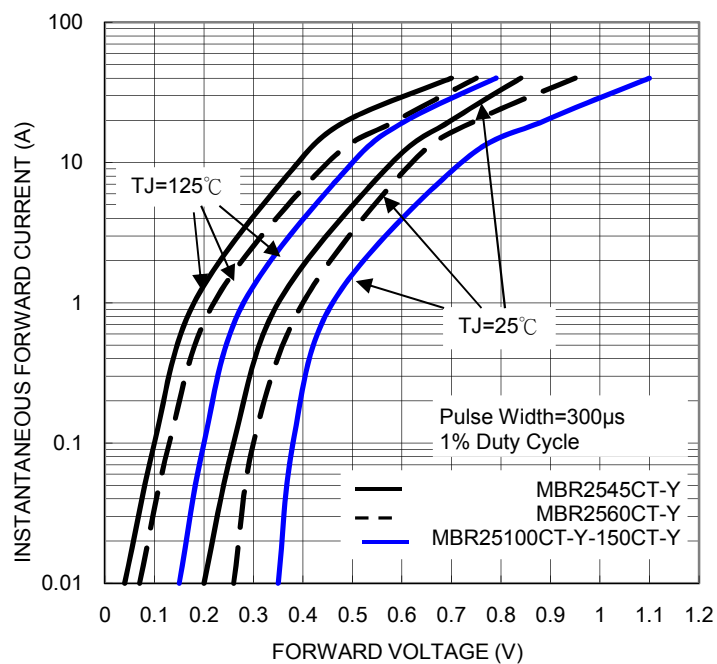

FIG. 4- TYPICAL REVERSE CHARACTERISTICS PER LEG

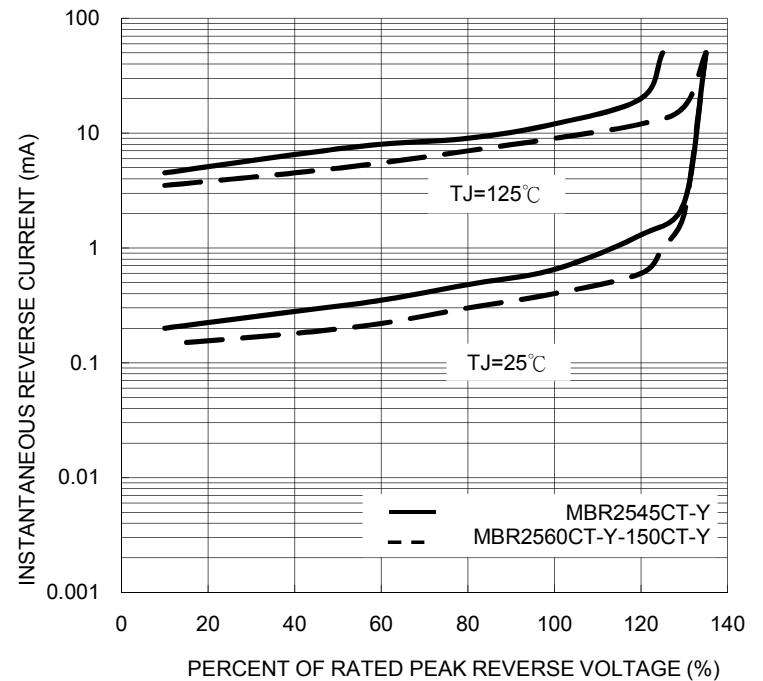

FIG. 5- TYPICAL JUNCTION CAPACITANCE PER LEG

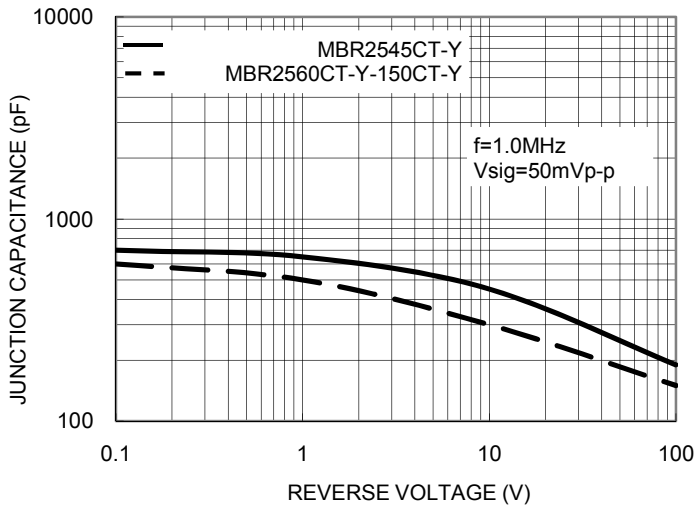
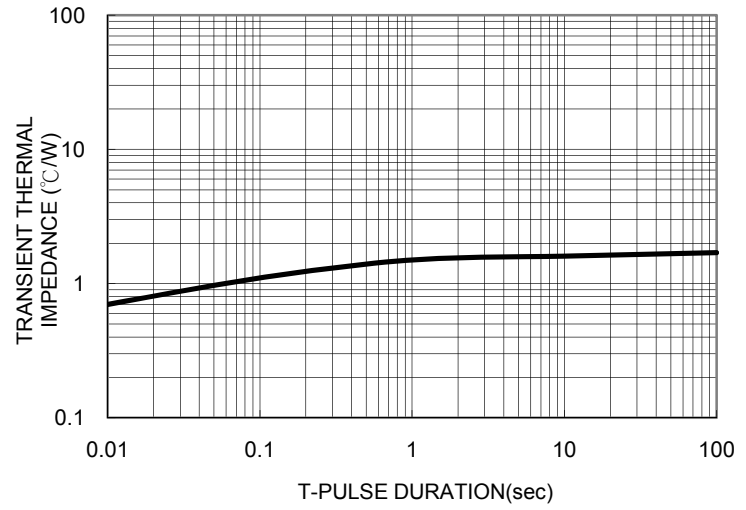
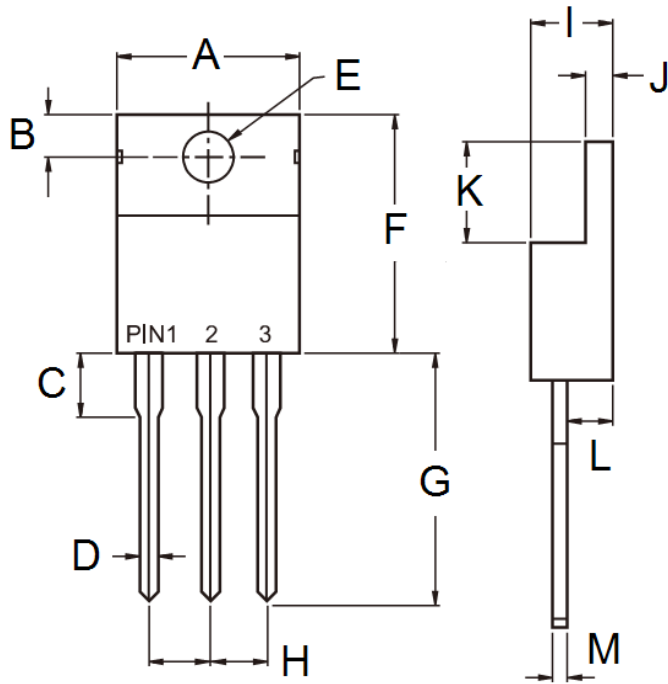

FIG. 6- TYPICAL TRANSIENT THERMAL IMPEDANCE PER LEG



PACKAGE OUTLINE DIMENSIONS



DIM.	Unit (mm)		Unit (inch)	
	Min	Max	Min	Max
A	-	10.50	-	0.413
B	2.62	3.44	0.103	0.135
C	2.80	4.20	0.110	0.165
D	0.68	0.94	0.027	0.037
E	3.54	4.00	0.139	0.157
F	14.60	16.00	0.575	0.630
G	13.19	14.79	0.519	0.582
H	2.41	2.67	0.095	0.105
I	4.42	4.76	0.174	0.187
J	1.14	1.40	0.045	0.055
K	5.84	6.86	0.230	0.270
L	2.20	2.80	0.087	0.110
M	0.35	0.64	0.014	0.025

MARKING DIAGRAM



- P/N = Marking Code
- G = Green Compound
- YWW = Date Code
- F = Factory Code

### Notice

Specifications of the products displayed herein are subject to change without notice. TSC or anyone on its behalf, assumes no responsibility or liability for any errors inaccuracies.

Information contained herein is intended to provide a product description only. No license, express or implied, to any intellectual property rights is granted by this document. Except as provided in TSC's terms and conditions of sale for such products, TSC assumes no liability whatsoever, and disclaims any express or implied warranty, relating to sale and/or use of TSC products including liability or warranties relating to fitness for a particular purpose, merchantability, or infringement of any patent, copyright, or other intellectual property right.

The products shown herein are not designed for use in medical, life-saving, or life-sustaining applications. Customers using or selling these products for use in such applications do so at their own risk and agree to fully indemnify TSC for any damages resulting from such improper use or sale.