

$I_{F(AV)} = 40\text{Amp}$
 $V_R = 45\text{V}$

Major Ratings and Characteristics

Characteristics	Values	Units
$I_{F(AV)}$ Rectangular waveform (Per Device)	40	A
I_{FRM} @ $T_C = 125^\circ\text{C}$ (Per Leg)	40	A
V_{RRM}	45	V
I_{FSM} @ $t_p = 5\ \mu\text{s}$ sine	1020	A
V_F @ $20\text{Apk}, T_J = 125^\circ\text{C}$	0.56	V
T_J range	-55 to 150	$^\circ\text{C}$

Description/ Features

The MBR4045WTPbF center tap Schottky rectifier has been optimized for very low forward voltage drop, with moderate leakage. The proprietary barrier technology allows for reliable operation up to 150°C junction temperature. Typical applications are in switching power supplies, converters, free-wheeling diodes, and reverse battery protection.

- 150°C T_J operation
- Center tap TO-247 package
- High purity, high temperature epoxy encapsulation for enhanced mechanical strength and moisture resistance
- Very low forward voltage drop
- High frequency operation
- Guard ring for enhanced ruggedness and long term reliability
- Lead-Free ("PbF" suffix)

Case Styles

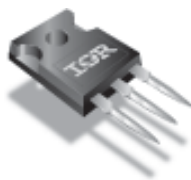

TO-247AC

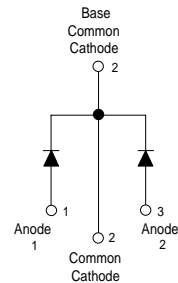

MBR4045WTPbF

Bulletin PD-20677 rev. B 11/06



Voltage Ratings

Part number	MBR4045WTPbF
V_R Max. DC Reverse Voltage (V)	45
V_{RWM} Max. Working Peak Reverse Voltage (V)	

Absolute Maximum Ratings

Parameters	Values	Units	Conditions
$I_{F(AV)}$ Max. Average Forward Current (Per Leg) (Per Device)	20 40	A	@ $T_C = 125^\circ\text{C}$, 50% duty cycle, rectangular waveform
I_{FRM} Peak Repetitive Forward Current (Per Leg)	40	A	Rated V_R , square wave, 20kHz $T_C = 125^\circ\text{C}$
I_{FSM} Max. Peak One Cycle Non-Repetitive Surge Current (Per Leg) See fig.7	1020 265	A	5 μs Sine or 3 μs Rect. pulse 10ms Sine or 6ms Rect. pulse Following any rated load condition and with rated V_{RWM} applied
E_{AS} Non-Repetitive Avalanche Energy (Per Leg)	20	mJ	$T_J = 25^\circ\text{C}$, $I_{AS} = 3$ Amps, $L = 4.40$ mH
I_{AR} Repetitive Avalanche Current (Per Leg)	3	A	Current decaying linearly to zero in 1 μsec Frequency limited by T_J max. $V_A = 1.5 \times V_R$ typical

Electrical Specifications

Parameters	Values	Units	Conditions
V_{FM} Max. Forward Voltage Drop (1)	0.59	V	@ 20A $T_J = 25^\circ\text{C}$
	0.78	V	@ 40A
	0.56	V	@ 20A $T_J = 125^\circ\text{C}$
	0.72	V	@ 40A
I_{RM} Max. Instantaneous Reverse Current (1)	1.75	mA	$T_J = 25^\circ\text{C}$
	50	mA	$T_J = 100^\circ\text{C}$
	85	mA	$T_J = 125^\circ\text{C}$
$V_{F(TO)}$ Threshold Voltage	0.29	V	$T_J = T_J$ max.
r_t Forward Slope Resistance	10.3	m Ω	
C_T Max. Junction Capacitance	900	pF	$V_R = 5V_{DC}$ (test signal range 100Khz to 1Mhz) 25°C
L_S Typical Series Inductance	7.5	nH	Measured from top of terminal to mounting plane
dv/dt Max. Voltage Rate of Change	10000	V/ μs	(Rated V_R)

(1) Pulse Width < 300 μs , Duty Cycle < 2%

Thermal-Mechanical Specifications

Parameters	Values	Units	Conditions
T_J Max. Junction Temperature Range	-55 to 150	$^\circ\text{C}$	
T_{stg} Max. Storage Temperature Range	-55 to 175	$^\circ\text{C}$	
R_{thJC} Max. Thermal Resistance Junction to Case (Per Package)	1.4	$^\circ\text{C/W}$	DC operation
R_{thCS} Typical Thermal Resistance Case to Heatsink	0.7	$^\circ\text{C/W}$	Mounting surface, smooth and greased
wt Approximate Weight	6(0.21)	g(oz.)	
T Mounting Torque	Min. 6(5)	Kg-cm (lbf-in)	
	Max. 12(10)		
Case Style	TO-247AC(TO-3P)		JEDEC
Device Marking	MBR4045WT		

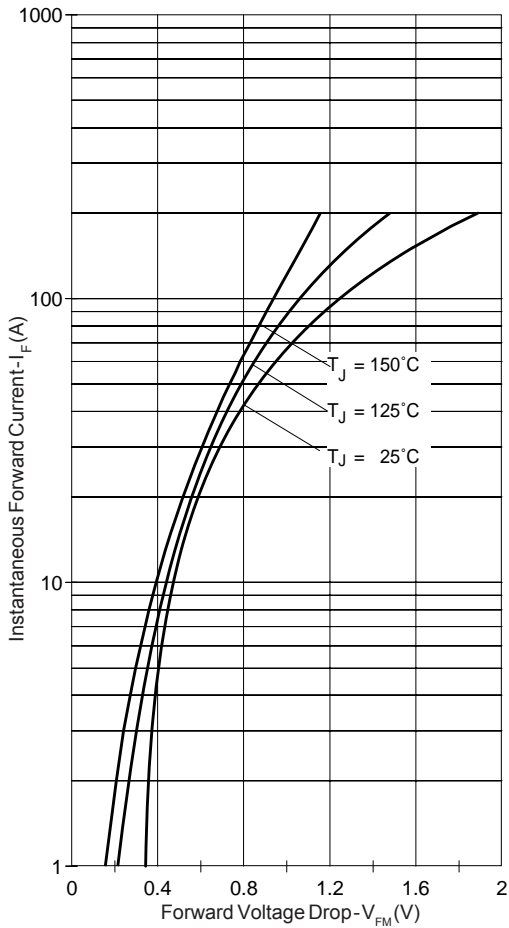

Fig. 1 - Max. Forward Voltage Drop Characteristics

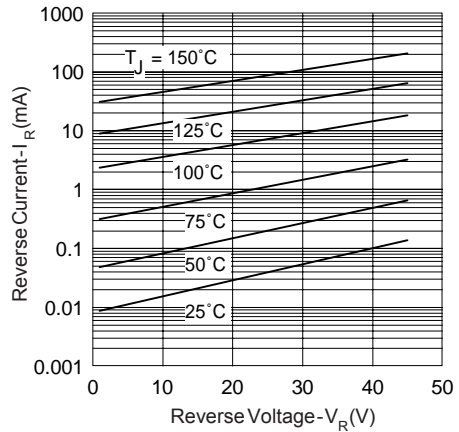

Fig. 2 - Typical Values Of Reverse Current Vs. Reverse Voltage

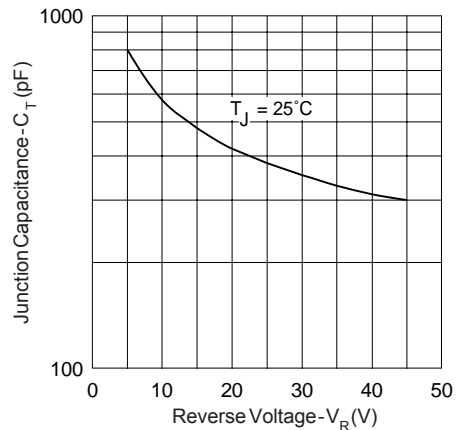

Fig. 3 - Typical Junction Capacitance Vs. Reverse Voltage

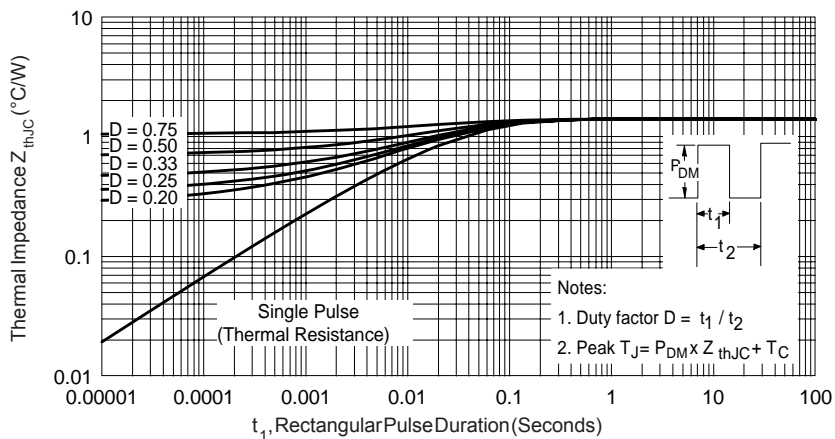

Fig. 4 - Max. Thermal Impedance Z_{thJC} Characteristics

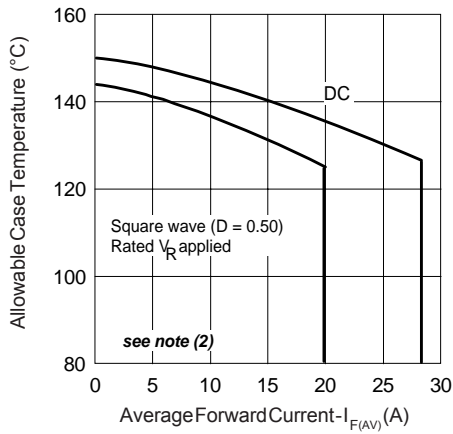

Fig. 5 - Max. Allowable Case Temperature Vs. Average Forward Current

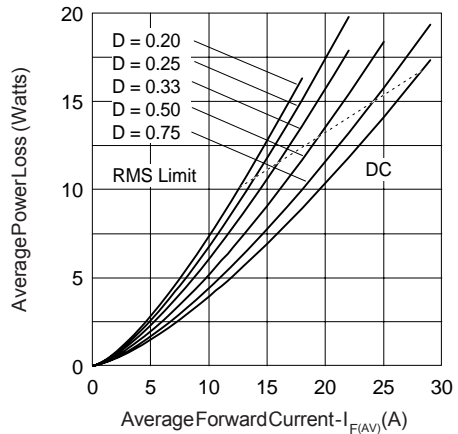

Fig. 6 - Forward Power Loss Characteristics

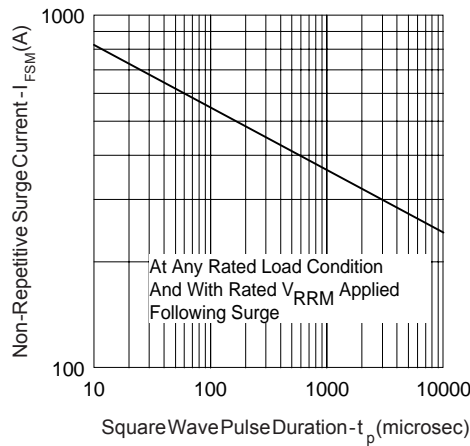

Fig. 7 - Max. Non-Repetitive Surge Current

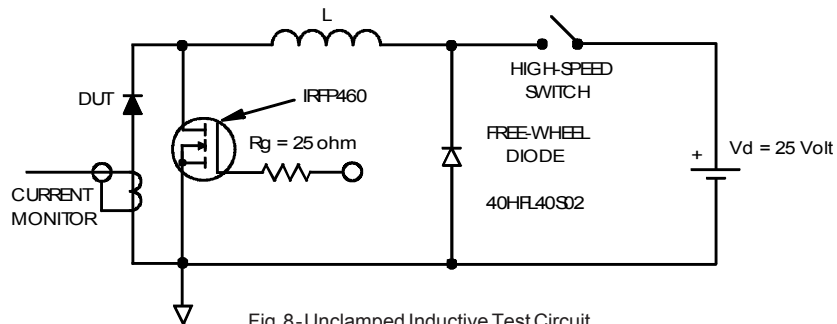
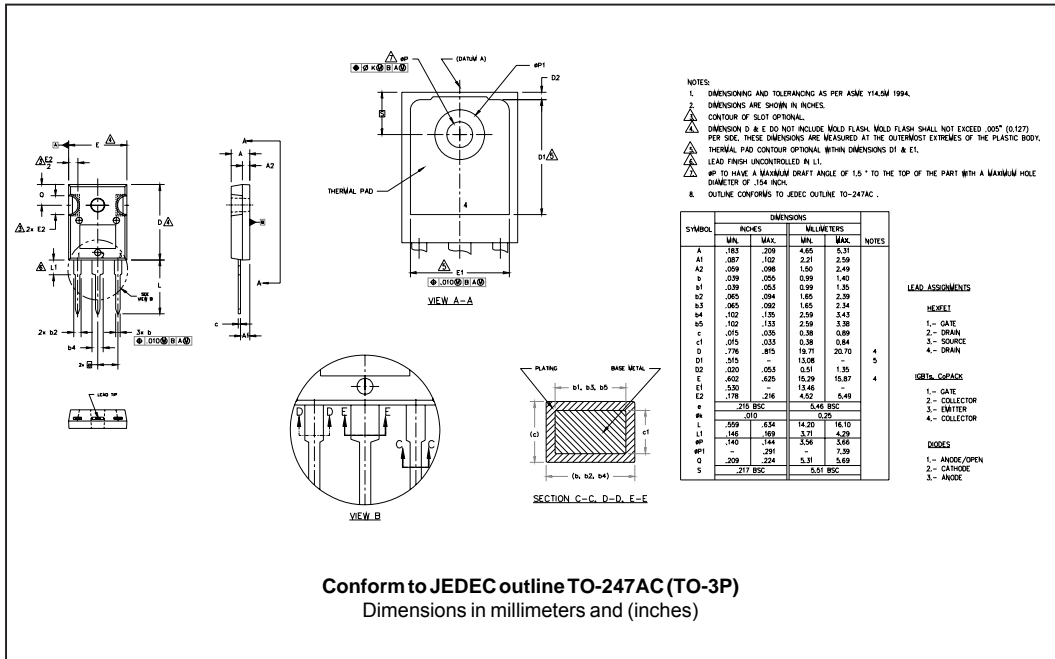

Fig. 8 - Unclamped Inductive Test Circuit

- (2) Formula used: $T_c = T_j - (P_d + P_{d_{REV}}) \times R_{thJC}$;
 $P_d = \text{Forward Power Loss} = I_{F(AV)} \times V_{FM} @ (I_{F(AV)} / D)$ (see Fig. 6);
 $P_{d_{REV}} = \text{Inverse Power Loss} = V_{R1} \times I_R (1 - D)$; $I_R @ V_{R1} = \text{rated } V_R$

Outline Table



Marking Information

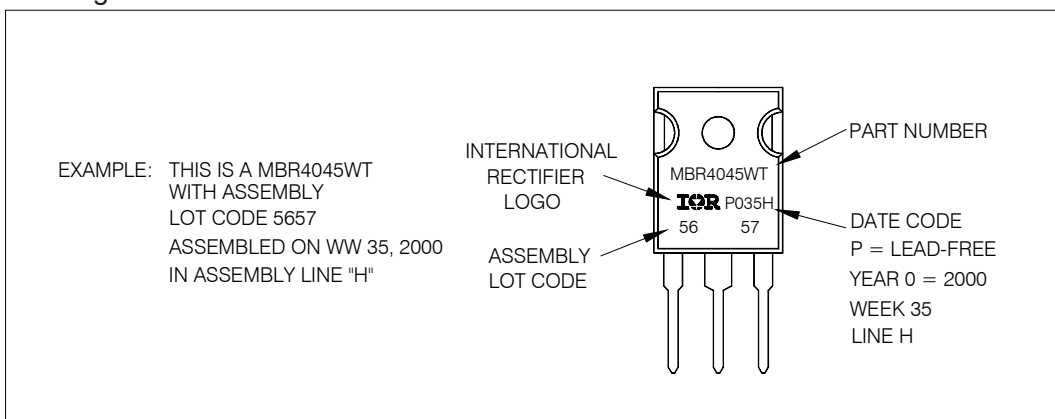

```

MBR4045WT
*****
    This model has been developed by
    Wizard SPICE MODEL GENERATOR (1999)
    (International Rectifier Corporation)
    contains Proprietary Information
*****
    SPICE Model Diode is composed by a
    simple diode plus paralld VCG2T
*****
.SUBCKT MBR4045WT ANO CAT
D1 ANO 1 DMOD (0.07089)
*Define diode model
.MODEL DMOD D(IS=1.87674447387184E-04A,N=1.0815129563336,BV=51V,
+IBV=0.370052071012812A,RS=0.000482052,CJO=1.77083341686508E-08,
+VJ=2.63120433908928,XTI=2,EG=0.680665296447736)
*****
*Implementation of VCG2T
VX 1 2 DC 0V
R1 2 CAT TRES 1E-6
.MODEL TRES RES(R=1,TC1=30.266567848718)
GP1 ANO CAT VALUE={-ABS(I(VX))*(EXP(((((-2.374754E-03/30.26657)*((V(2,CAT)*1E6)/(I(VX)+1E-6)-
1)))+1)*6.049001E-02*ABS(V(ANO,CAT))))-1}}
*****
.ENDS MBR4045WT

Thermal Model Subcircuit
.SUBCKT MBR4045WT 5 1

CTHERM1    5    4    8.75E-01
CTHERM2    4    3    1.19E+01
CTHERM3    3    2    7.69E+01
CTHERM4    2    1    4.98E+02

R THERM1    5    4    1.00E-04
R THERM2    4    3    7.15E-01
R THERM1    3    2    5.30E-01
R THERM1    2    1    1.50E-01

.ENDS MBR4045WT
    
```

Ordering Information Table

Device Code				
MBR	40	45	WT	PbF
①	②	③	④	⑤
1	-	Schottky MBR Series		
2	-	Current Rating (40 = 40A)		
3	-	Voltage Rating (45 = 45V)		
4	-	Circuit Configuration : Center Tap (Dual) TO-247		
5	-	<ul style="list-style-type: none">• none = Standard Production• PbF = Lead-Free		

Data and specifications subject to change without notice.
This product has been designed and qualified for Industrial Level and Lead-Free.
Qualification Standards can be found on IR's Web site.