

Dual Common-Cathode Schottky Rectifier, 60A (30A x2), 60V



FEATURES

- 150°C T_J operation
- High frequency operation
- Low forward voltage drop
- High purity, high temperature epoxy encapsulation for enhanced mechanical strength and moisture resistance
- Guard ring for enhanced ruggedness, long term reliability and overvoltage protection
- Compliant to RoHS
- Designed and qualified according to JEDEC-JESD47
- Solder bath temperature 260°C maximum, 40 s per JESD 22B-106 (for TO-247AB package)

DESCRIPTION

The **MBR6060PT** Schottky rectifier has been optimized for low reverse leakage at high temperature. The proprietary barrier technology allows for reliable operation up to 150°C junction temperature.

APPLICATIONS

- Switching mode power supplies
- DC to DC converters
- Freewheeling diodes
- Reverse battery protection.

MECHANICAL DATA

Case: TO-247AB (TO-3P)

Molding compound meets UL 94 V-0 flammability rating

Terminals: Mat tin plated leads, solderable per J-STD-002 and JESD 22-B102

Polarity: As marked

Mounting Torque: 10 in-lbs maximum

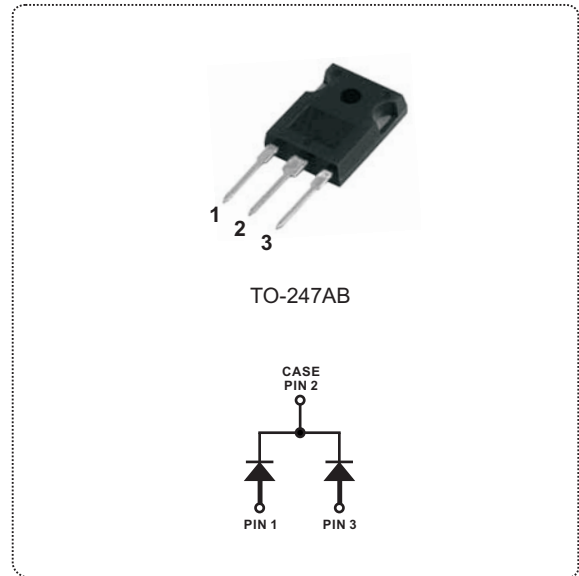

PRODUCT SUMMARY	
I _{F(AV)}	30A x 2
V _R	60V
V _F at I _F	0.65V
I _{RM max.}	100mA at 125°C
T _{J max.}	150°C
Diode variation	Dual dice, Common cathode
E _{AS}	27 mJ

MAJOR RATINGS AND CHARACTERISTICS			
SYMBOL	CHARACTERISTICS	VALUE	UNIT
I _{F(AV)}	Rectangular waveform	30 x 2	A
V _R		60	V
I _{FSM}	8.3 ms single half sine-wave	400	A
V _F	30 A _{pk} , T _J = 125°C	0.65	V
T _J	Range	-65 to 150	°C

VOLTAGE RATINGS			
PARAMETER	SYMBOL	VALUE	UNIT
Maximum DC reverse voltage	V_R	60	V
Maximum working peak reverse voltage	V_{RWM}		
Maximum DC blocking voltage	V_{DC}		

ABSOLUTE MAXIMUM RATINGS				
PARAMETER	SYMBOL	TEST CONDITIONS	VALUE	UNIT
Maximum average forward current <small>per device per diode</small>	$I_{F(AV)}$	$T_C = 122^\circ\text{C}$, rated V_R	60	A
			30	
Non-repetitive peak surge current	I_{FSM}	Surge applied at rated load condition half wave single phase 60 Hz	400	A
Non-repetitive avalanche energy	E_{AS}	$T_J = 25^\circ\text{C}$, $I_{AS} = 4\text{A}$, $L = 3.4\text{mH}$	27	mJ
Repetitive avalanche current	I_{AR}	Current decaying linearly to zero in $1\ \mu\text{s}$ Frequency limited by T_J maximum $V_A = 1.5 \times V_R$ typical	6	A

ELECTRICAL SPECIFICATIONS					
PARAMETER	SYMBOL	TEST CONDITIONS	VALUE	UNIT	
Maximum forward voltage drop	$V_{FM}^{(1)}$	$I_F = 30\text{A}$	$T_J = 25^\circ\text{C}$	0.76	V
		$I_F = 60\text{A}$		0.90	
		$I_F = 30\text{A}$	$T_J = 125^\circ\text{C}$	0.65	
		$I_F = 60\text{A}$		0.80	
Maximum instantaneous reverse current	$I_{RM}^{(1)}$	$T_J = 25^\circ\text{C}$	Rated DC voltage	1	mA
		$T_J = 125^\circ\text{C}$		100	
Maximum junction capacitance	C_T	$V_R = 5\ V_{DC}$ (test signal range 100 kHz to 1 MHz) 25°C	800	pF	
Typical series inductance	L_S	Measured from top of terminal to mounting plane	7.5	nH	
Maximum voltage rate of change	dV/dt	Rated V_R	10000	V/ μs	

Note

(1) Pulse width < 300 μs , duty cycle < 2%

THERMAL - MECHANICAL SPECIFICATIONS							
PARAMETER	SYMBOL	TEST CONDITIONS	VALUE	UNIT			
Maximum junction temperature range	T_J		-65 to 150	°C			
Maximum storage temperature range	T_{stg}		-65 to 175				
Maximum thermal resistance, junction to case	R_{thJC}	DC operation	1.0	°C/W			
Typical thermal resistance, case to heatsink	R_{thCS}	Mounting surface, smooth and greased	0.24				
Approximate weight			6.2	g			
			0.22	oz.			
Mounting torque	<table border="0"> <tr> <td style="text-align: center;">minimum</td> <td rowspan="2" style="border: none;"></td> </tr> <tr> <td style="text-align: center;">maximum</td> </tr> </table>	minimum		maximum		6 (5)	kgf · cm (lbf · in)
		minimum					
maximum							
12 (10)							
Marking device		Case style TO-247 AB	MBR6060PT				

Ordering Information Table

Device code

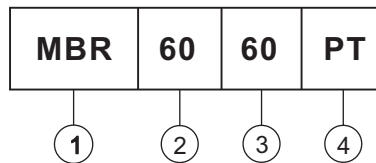

- ① - Schottky MBR series
- ② - Current rating (60 = 60A, 30A x 2)
- ③ - Voltage ratings, 60 = 60V
- ④ - Circuit configuration, Center tap common cathode, TO-247 AB series package

Fig.1 Maximum forward voltage drop characteristics (Per Leg)

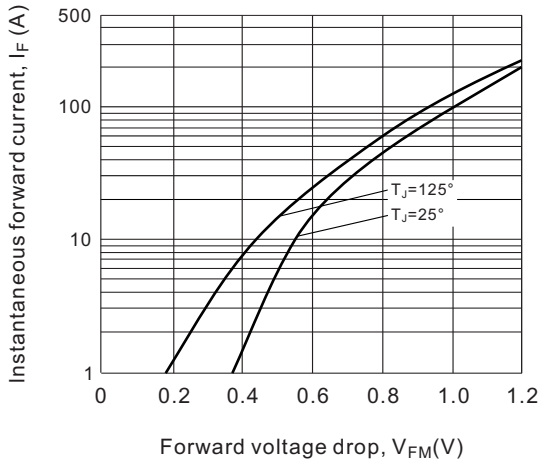

Fig.2 Typical values of reverse current vs. reverse voltage (Per Leg)

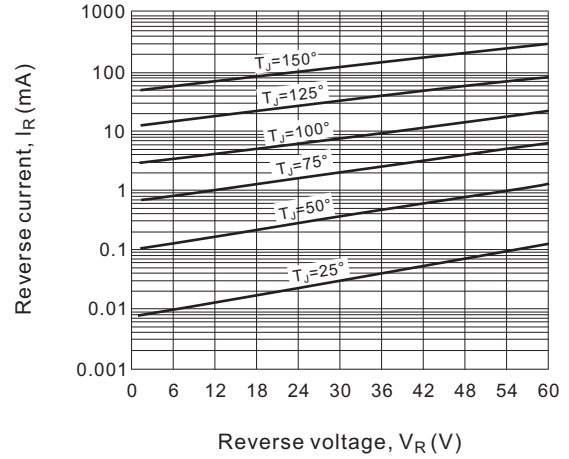

Fig.3 Typical junction capacitance vs. reverse voltage (Per Leg)

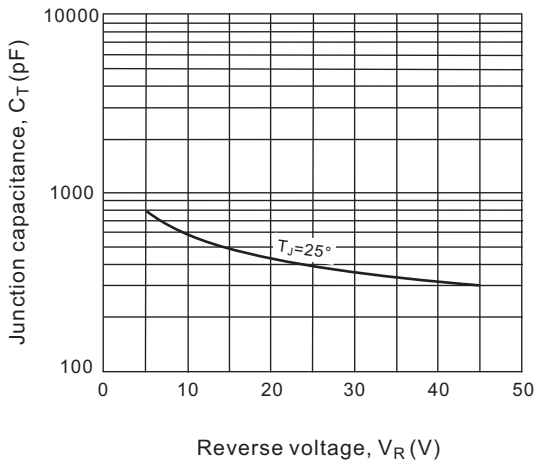

Fig.4 Maximum allowable case temperature vs. average forward current (Per Leg)

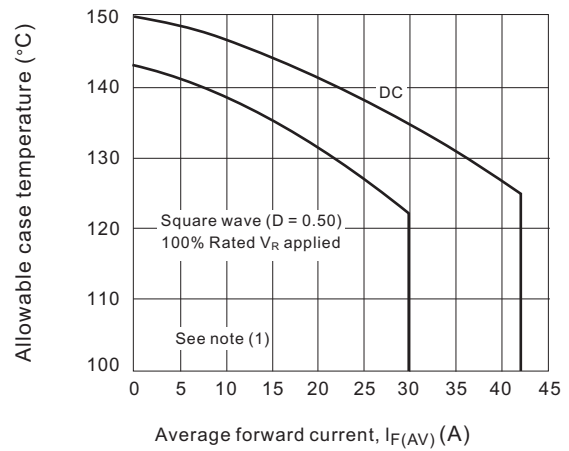

Fig.5 Maximum thermal impedance $R_{th(j-c)}$ characteristics (Per Leg)

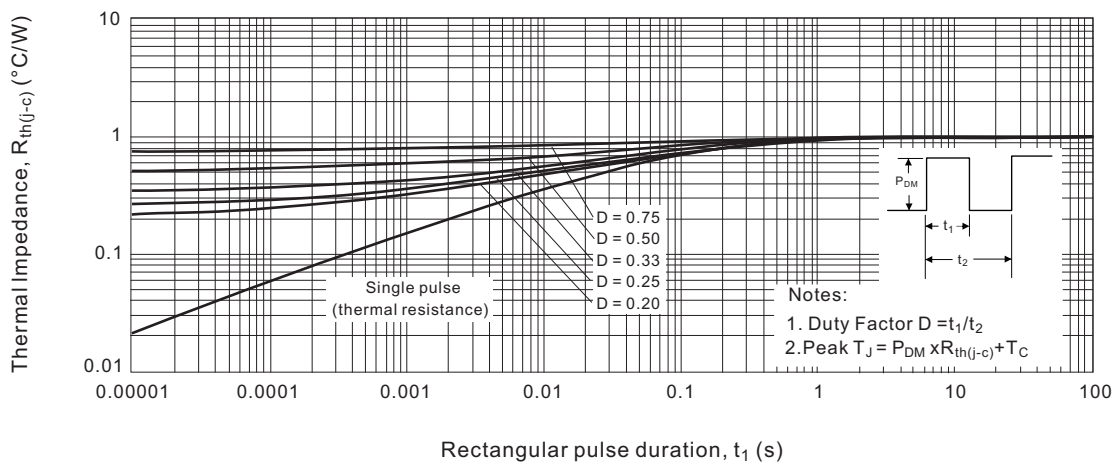

Fig.6 Forward power loss characteristics (Per Leg)

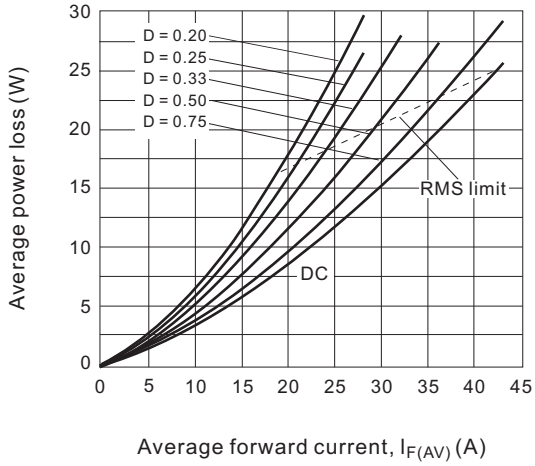

Fig.7 Maximum non-repetitive peak forward surge current (Per Leg)

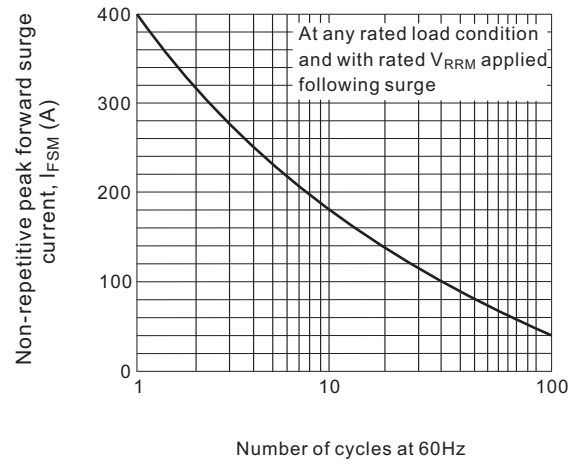
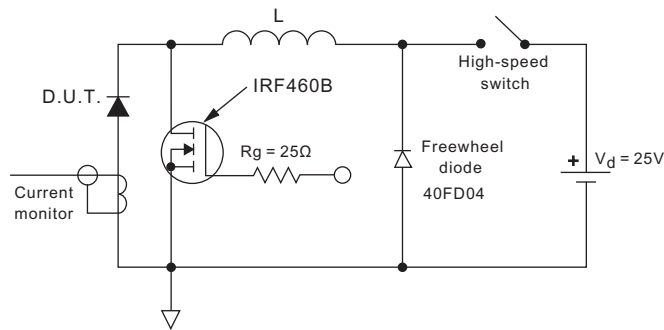

Fig.8 Unclamped inductive test circuit



Note

(1) Formula used: $T_C = T_J - (P_d + P_{dREV}) \times R_{thJC}$;

P_d = Forward power loss = $I_{F(AV)} \times V_{FM}$ at $(I_{F(AV)}/D)$ (see fig.6);

P_{dREV} = Inverse power loss = $V_{R1} \times I_R (1-D)$; I_R at $V_{R1} = 100\%$ Rated V_R

