

## High Power Schottky Barrier Rectifier

### Package Outline Dimensions ( millimeters )

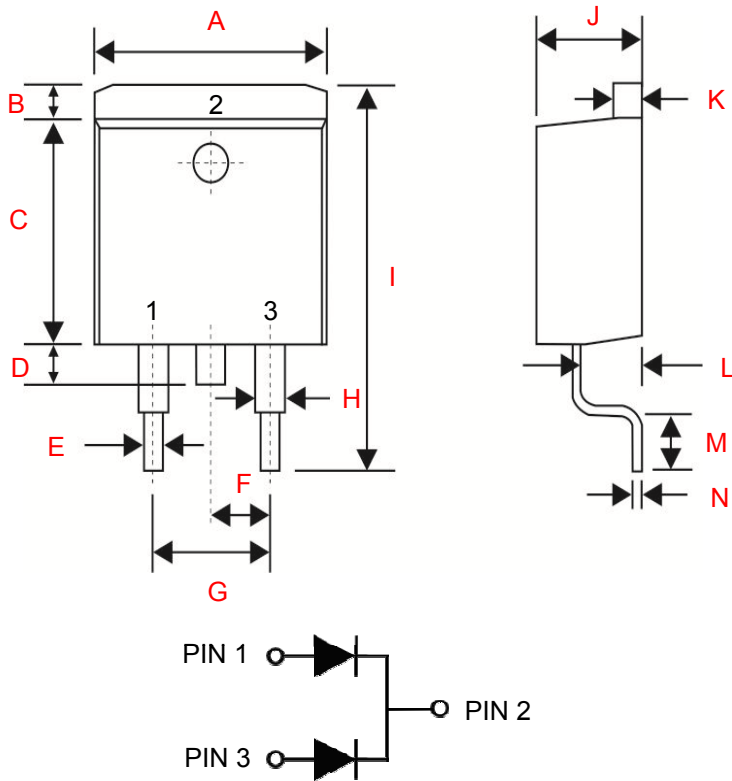

TO-263 (D <sup>2</sup> PAK)		
Dim.	Min.	Max.
A	10.01	10.31
B	1.27	1.40
C	8.76	9.02
D	1.30	1.75
E	0.71	0.91
F	2.54 BSC	
G	4.98	5.18
H	1.17	1.37
I	15.00	15.85
J	4.47	4.67
K	1.17	1.37
L	2.52	2.82
M	2.29	2.79
N	0.28	0.48
All Dimensions in millimeter		

### Features

- High Current Capability
- Low Switching Noise
- High Surge Capability
- Low Power Loss & High Efficiency
- Guard Ring Protection
- Pd-free lead plating & Halogen-free part

### Mechanical

- Molded Plastic Low profile TO-263 (D<sup>2</sup>PAK)
- Plastic materials used carries underwriters laboratory flammability classification 94V-0
- Lead Temperature for Soldering Purposes : 265°C Max. for 10 Seconds
- Device Weight : Approximated 1.70 grams

### Maximum Ratings & Electrical Characteristics ( T<sub>A</sub> = 25°C unless otherwise specified )

Parameter	Symbol	MBRB 1040CT	MBRB 1060CT	Units	
DC Blocking Voltage	V <sub>RM</sub>	40	60		
Working Peak Reverse Voltage	V <sub>RWM</sub>	28	42	Volts	
Peak Repetitive Reverse Voltage	V <sub>RRM</sub>	40	60		
Average Rectified Output Current (Total Device)	I <sub>O</sub>	10		Amps	
Non-Repetitive Peak Forward Surge Current (Per Leg) (Surge applied at rated load conditions half wave, single phase, 60Hz)	I <sub>FSM</sub>	125		Amps	
Instantaneous Forward Voltage (Per Leg)	V <sub>F</sub>	I <sub>F</sub> = 5A , T <sub>A</sub> = 25°C I <sub>F</sub> = 5A , T <sub>A</sub> = 125°C	0.65 0.55	0.75 0.65	Volts
Instantaneous Reverse Current (Per Leg)	I <sub>R</sub>	V <sub>R</sub> = V <sub>RRM</sub> , T <sub>A</sub> = 25°C V <sub>R</sub> = V <sub>RRM</sub> , T <sub>A</sub> = 125°C	0.1 10	mA	

NOTE : 1. Test with 2inch Al board

**Thermal Characteristics** (  $T_A = 25^\circ\text{C}$  unless otherwise specified ) (Per Leg)

Parameter	Symbol	Value	Units
Maximum Thermal Resistance Junction to Case	$R\theta_{JC}$	5.0	$^\circ\text{C} / \text{W}$
Operating & Storage Junction Temperature	$T_J$	150	$^\circ\text{C}$
	$T_{STG}$	- 65 to +150	

**Ratings and Characteristics Curves** (  $T_A = 25^\circ\text{C}$  unless otherwise specified )

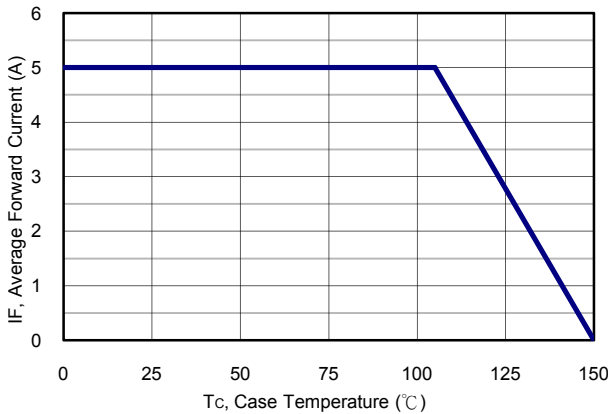

Figure 1: Current Derating Curves (Per Leg)

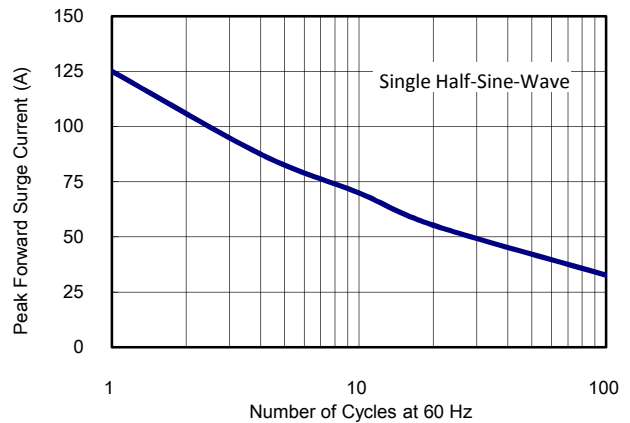

Figure 2: Peak Forward Surge Current (Per Leg)

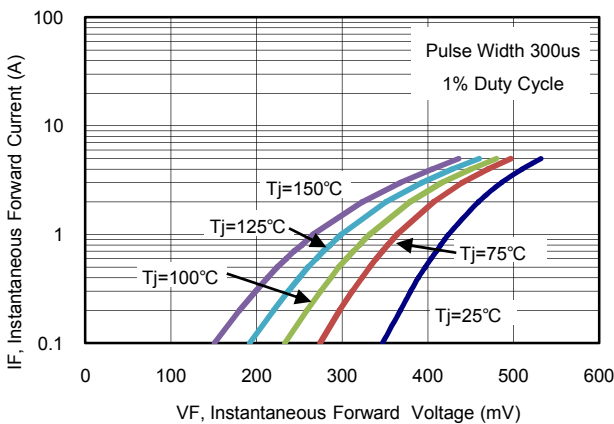

Figure 3: Typical Forward Characteristics (MBRB1040CT) (Per Leg)

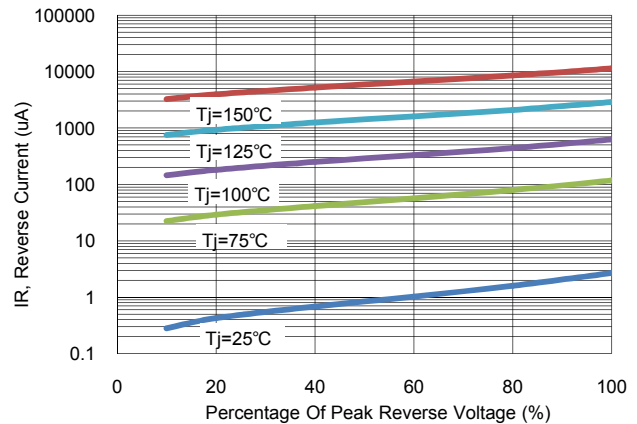

Figure 4: Typical Reverse Characteristics (MBRB1040CT) (Per Leg)

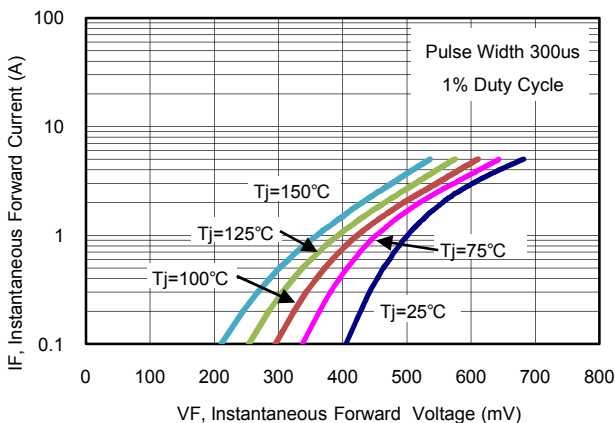

Figure 5: Typical Forward Characteristics (MBRB1060CT) (Per Leg)

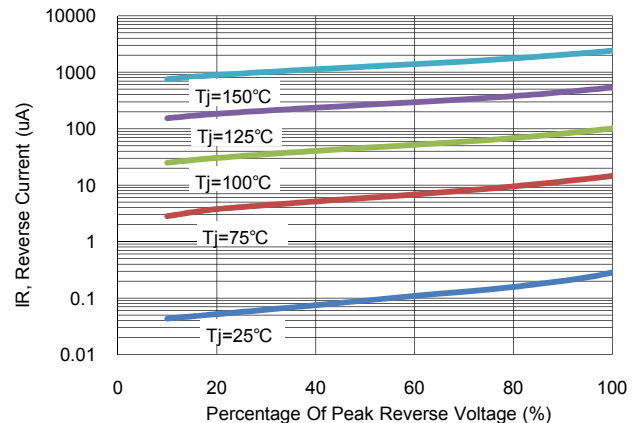
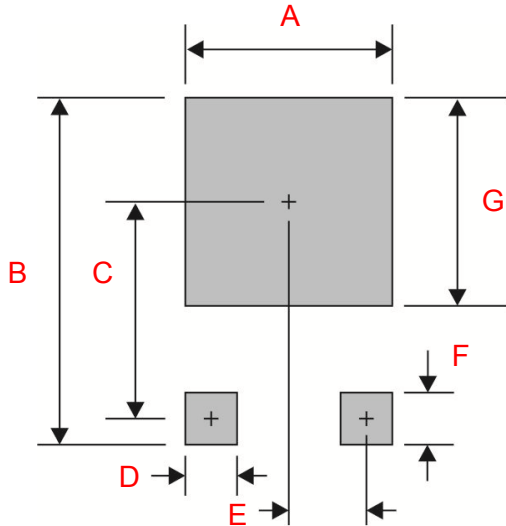

Figure 6: Typical Reverse Characteristics (MBRB1060CT) (Per Leg)

**Suggested Pad Layout**

TO-263 (D2PAK)	
Symbol	Dimensions
A	10.80
B	16.90
C	9.50
D	1.80
E	2.50
F	3.50
G	11.40
All Dimensions in millimeter	

**Ordering information**

Part Number	Package	Delivery mode
MBRB1040CT / MBRB1060CT	TO-263 (D2PAK)	800 pieces / 13" Reel

**Tape and Reel Dimensions ( millimeters )**

Surface Mount Device are packed in accordance with EIA standard RS-481-D and specification.

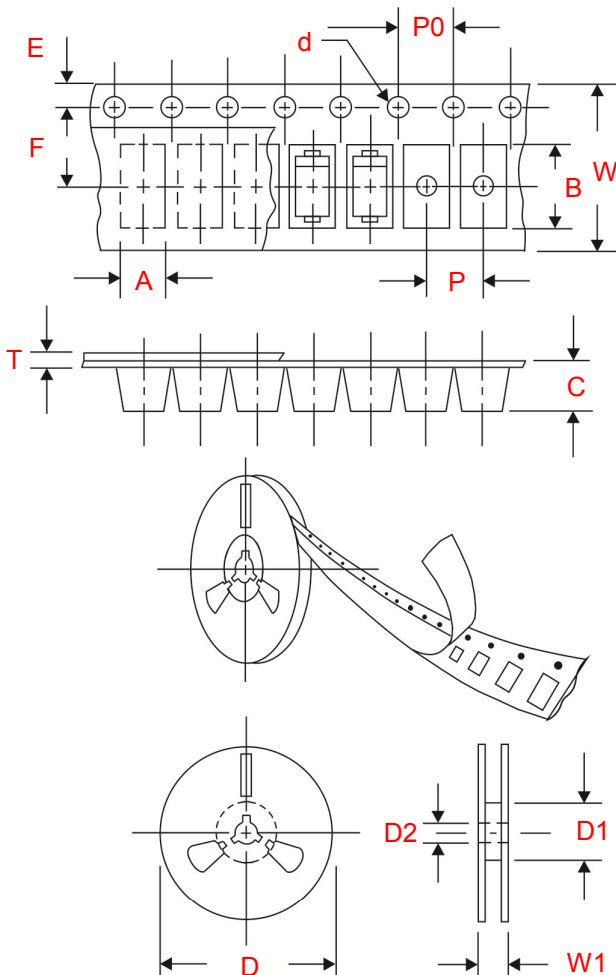

Item	Symbol	Dimensions (mm)
		TO-263 (D2PAK)
Carrier width	A	10.6 ± 0.1
Carrier length	B	15.8 ± 0.1
Carrier depth	C	4.9 ± 0.1
Sprocket hole	d	1.6 ± 0.1
Reel outside diameter	D	330.0 ± 1.0
Reel inner diameter	D1	102.0 ± 1.0
Feed hole diameter	D2	13.0 ± 1.0
Stocket hole position	E	1.75 ± 0.1
Punch hole position	F	11.5 ± 0.1
Punch hole pitch	P	16.0 ± 0.1
Sprocket hole pitch	P0	4.0 ± 0.1
Total tape thickness	T	0.35 ± 0.1
Tape width	W	24.0 ± 0.3
Reel width	W1	19.1 ± 1.5

## **Disclaimer**

All product specifications and data are subject to change without notice.

Sooner Power Semiconductor Co. Ltd., its affiliates, agents, and employees, and all persons acting on its or their behalf (collectively, "SPS"), disclaim any and all liability for any errors, inaccuracies or incompleteness contained herein or in any other disclosure relating to any product.

SPS disclaims any and all liability arising out of the use or application of any product described herein or of any information provided herein to the maximum extent permitted by law. The product specifications do not expand or otherwise modify SPS's terms and conditions of purchase, including but not limited to the warranty expressed therein, which apply to these products.

No license, express or implied, by estoppel or otherwise, to any intellectual property rights is granted by this document or by any conduct of SPS.

The products shown herein are not designed for use in medical, life-saving, or life-sustaining applications unless otherwise expressly indicated. Customers using or selling SPS products not expressly indicated for use in such applications do so entirely at their own risk and agree to fully indemnify SPS for any damages arising or resulting from such use or sales. Please contact authorized SPS personnel to obtain written terms and conditions regarding products designed for such applications.

Products names and markings noted herein may be trademarks of their respective owners.