

International IR Rectifier

MBR1635/ MBR1645 MBRB1635/ MBRB1645

SCHOTTKY RECTIFIER

16 Amp

Major Ratings and Characteristics

Characteristics	MBR16..	Units
$I_{F(AV)}$ Rectangular waveform	16	A
V_{RRM}	35/45	V
I_{FSM} @ $t_p=5\ \mu s$ sine	1800	A
V_F @ 16Apk, $T_J=125^\circ C$	0.57	V
T_J	-65 to 150	$^\circ C$

Description/ Features

The MBR16.. Schottky rectifier has been optimized for low reverse leakage at high temperature. The proprietary barrier technology allows for reliable operation up to 150° C junction temperature. Typical applications are in switching power supplies, converters, free-wheeling diodes, and reverse battery protection.

- 150° C T_J operation
- High purity, high temperature epoxy encapsulation for enhanced mechanical strength and moisture resistance
- Low forward voltage drop
- High frequency operation
- Guard ring for enhanced ruggedness and long term reliability

Case Styles

MBR1635/ MBR1645

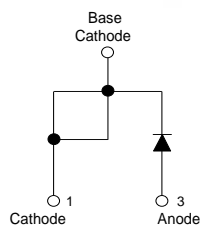

TO-220AC

MBRB1635/ MBRB1645

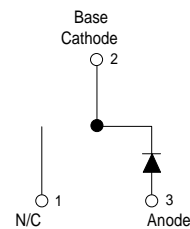

D²PAK

Voltage Ratings

Part number	MBR1635	MBR1645
V_R Max. DC Reverse Voltage (V)	35	45
V_{RWM} Max. Working Peak Reverse Voltage (V)		

Absolute Maximum Ratings

Parameters	MBR16..	Units	Conditions
$I_{F(AV)}$ Max. Average Forward Current	16	A	@ $T_C = 125^\circ\text{C}$, (Rated V_R)
I_{FSM} Non-Repetitive Peak Surge Current	1800	A	5 μs Sine or 3 μs Rect. pulse Following any rated load condition and with rated V_{RWM} applied
	150		Surge applied at rated load condition halfwave single phase 60Hz
E_{AS} Non-Repetitive Avalanche Energy	24	mJ	$T_J = 25^\circ\text{C}$, $I_{AS} = 3.6$ Amps, $L = 3.7$ mH
I_{AR} Repetitive Avalanche Current	3.6	A	Current decaying linearly to zero in 1 μsec Frequency limited by T_J , max. $V_A = 1.5 \times V_R$ typical

Electrical Specifications

Parameters	MBR16..	Units	Conditions
V_{FM} Max. Forward Voltage Drop(1)	0.63	V	@ 16A, $T_J = 25^\circ\text{C}$
	0.57	V	@ 16A, $T_J = 125^\circ\text{C}$
I_{RM} Max. Instantaneous Reverse Current (1)	0.2	mA	$T_J = 25^\circ\text{C}$ Rated DC voltage
	40	mA	$T_J = 125^\circ\text{C}$
C_T Max. Junction Capacitance	1400	pF	$V_R = 5V_{DC}$, (test signal range 100Khz to 1Mhz) 25°C
L_S Typical Series Inductance	8.0	nH	Measured from top of terminal to mounting plane
dv/dt Max. Voltage Rate of Change (Rated V_R)	10000	V/ μs	

(1) Pulse Width < 300 μs , Duty Cycle <2%

Thermal-Mechanical Specifications

Parameters	MBR16..	Units	Conditions
T_J Max. Junction Temperature Range	-65 to 150	$^\circ\text{C}$	
T_{stg} Max. Storage Temperature Range	-65 to 175	$^\circ\text{C}$	
R_{thJC} Max. Thermal Resistance Junction to Case	1.50	$^\circ\text{C}/\text{W}$	DC operation
R_{thCS} Typical Thermal Resistance, Case to Heatsink	0.50	$^\circ\text{C}/\text{W}$	Mounting surface, smooth and greased
wt Approximate Weight	2 (0.07)	g (oz.)	
T Mounting Torque	Min. 6 (5)	Kg-cm (lbf-in)	
	Max. 12 (10)		
Case Style	TO-220AC		JEDEC

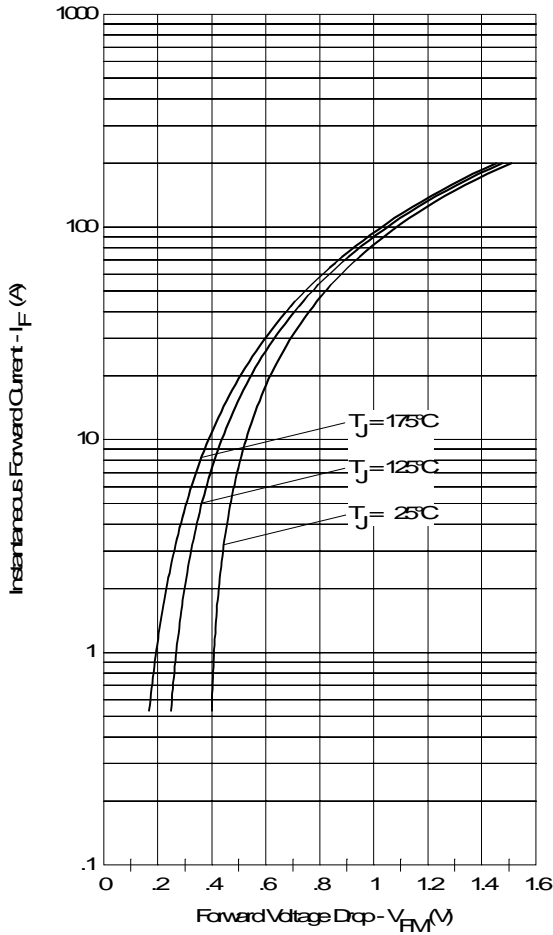

Fig. 1 - Maximum Forward Voltage Drop Characteristics

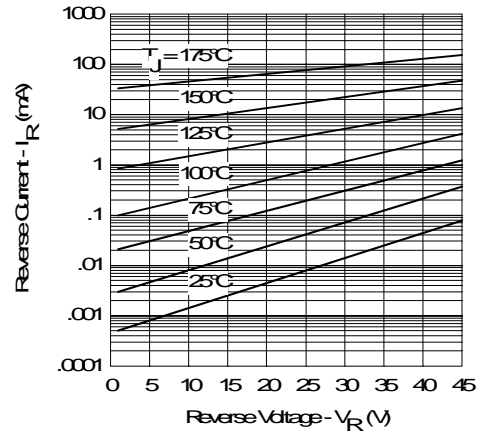

Fig. 2 - Typical Values of Reverse Current Vs. Reverse Voltage

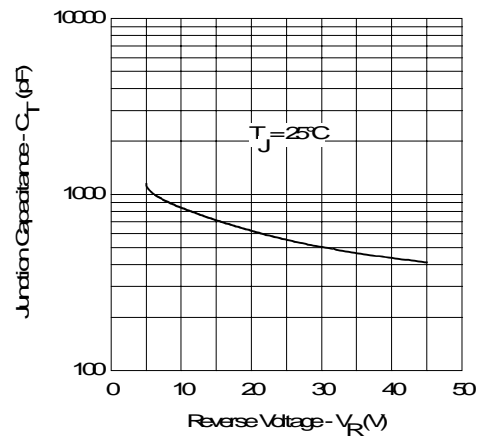

Fig. 3 - Typical Junction Capacitance Vs. Reverse Voltage

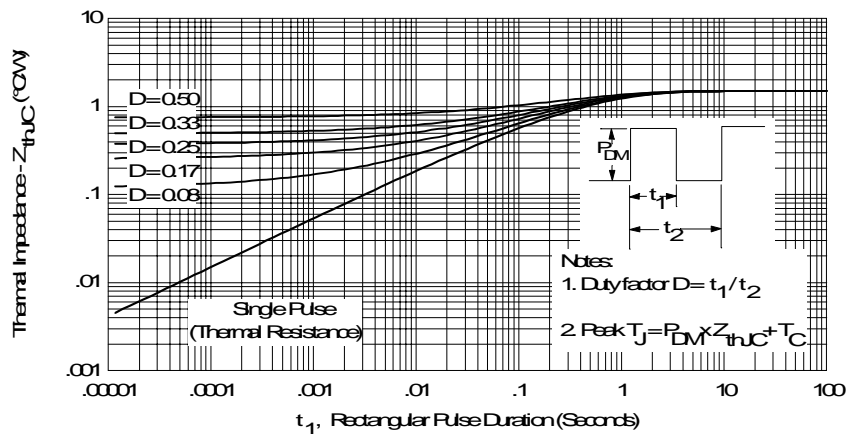

Fig. 4 - Maximum Thermal Impedance Z_{thJC} Characteristics

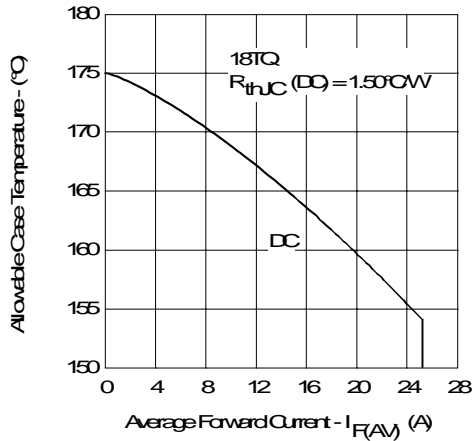

Fig. 5 - Maximum Allowable Case Temperature Vs. Average Forward Current

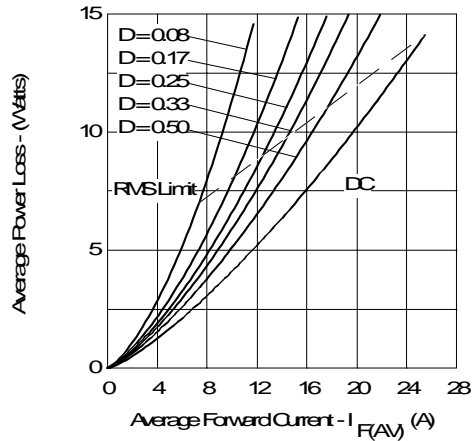

Fig. 6 - Forward Power Loss Characteristics

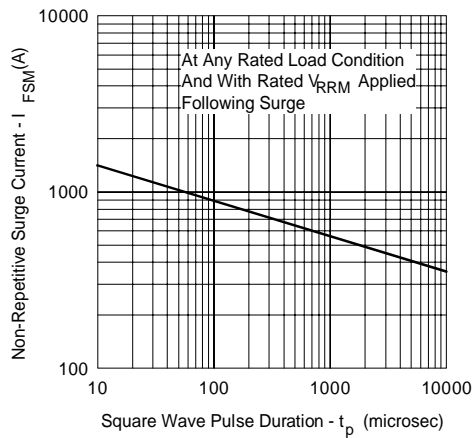

Fig. 7 - Maximum Non-Repetitive Surge Current

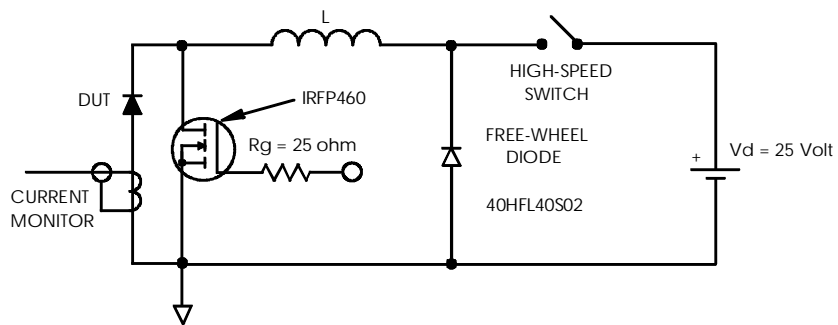
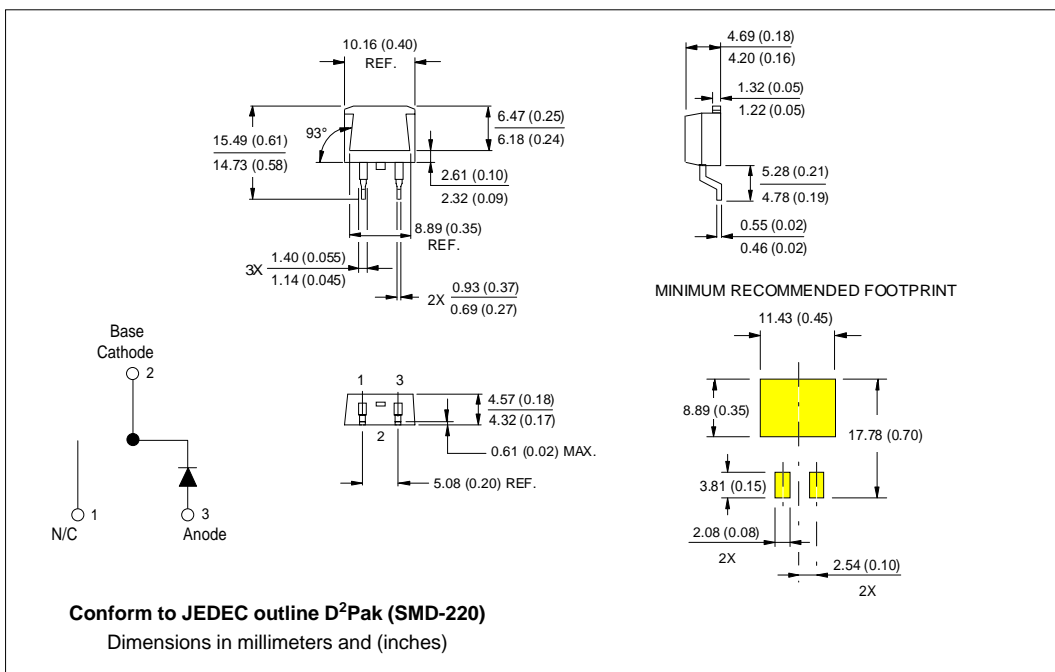
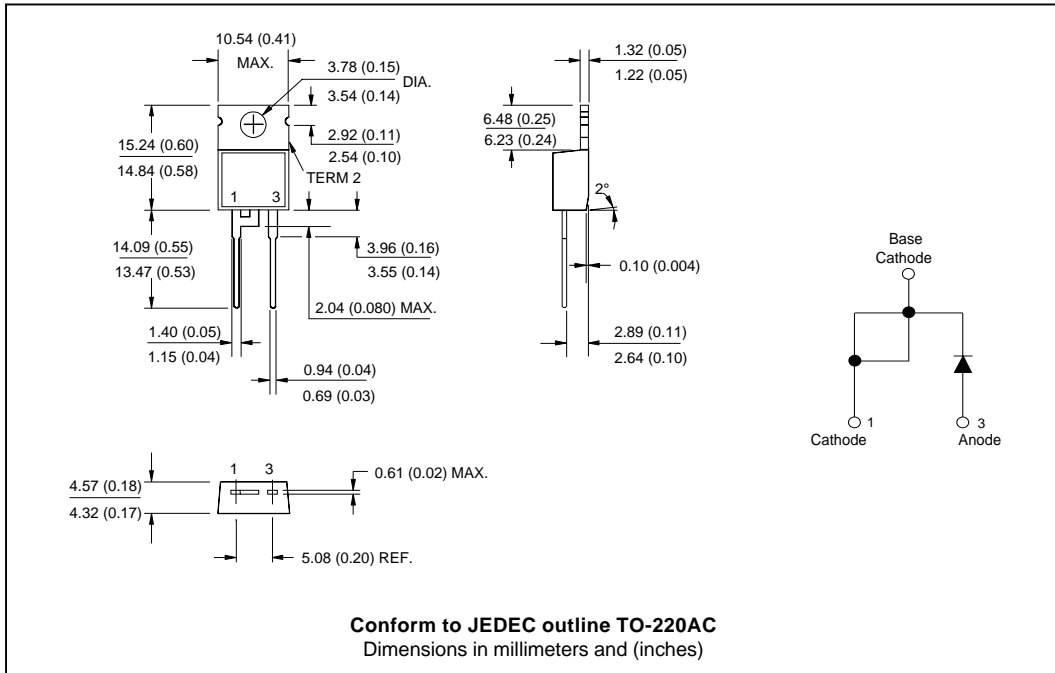

Fig. 8 - Unclamped Inductive Test Circuit

Outline Table



Data and specifications subject to change without notice.
This product has been designed and qualified for Industrial Level.
Qualification Standards can be found on IR's Web site.

International
IOR Rectifier

IR WORLD HEADQUARTERS: 233 Kansas St., El Segundo, California 90245, USA Tel: (310) 252-7105
TAC Fax: (310) 252-7309
Visit us at www.irf.com for sales contact information. 01/03