

MBRB20100CT

Rev.F May.-2016

描述 / Descriptions

TO-263 塑封封装 肖特基二极管。
Schottky Diode in a TO-263 Plastic Package.

特征 / Features

损耗低，效率高。
Low power loss, high efficiency.

用途 / Applications

用于高频、低压、大电流整流二极管，续流二极管，保护二极管。
For use in low voltage, high frequency inverters, free wheeling, and polarity protection applications.

内部等效电路 / Equivalent Circuit

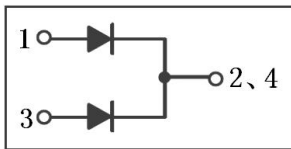

引脚排列 / Pinning



PIN1 : Anode PIN 2、 4 : Cathode PIN 3 : Anode

放大及印章代码 / h_{FE} Classifications & Marking

见印章说明。 See Marking Instructions.

极限参数 / Absolute Maximum Ratings(Ta=25°C)

参数 Parameter	符号 Symbol	数值 Rating	单位 Unit
Peak Repetitive Reverse Voltage	V_{RRM}	100	V
Working Peak Reverse Voltage	V_{RWM}	100	V
Peak Repetitive Forward Current	I_{FRM}	20	A
Average Rectified Forward Current	$I_{F(AV)}$	10	A
	$I_{F(AV)}^{(total)}$	20	A
Non Repetitive Peak Surge Current	I_{FSM}	150	A
Peak Repetitive Reverse Surge Current	I_{RRM}	0.5	A
Thermal Resistance Junction to Case	$R_{\theta Jc}$	2.0	°C/W
Junction Temperature Range	T_j	150	°C
Storage Temperature Range	T_{stg}	-55~150	°C

电性能参数 / Electrical Characteristics(Ta=25°C)

参数 Parameter	符号 Symbol	测试条件 Test Conditions	最小值 Min	典型值 Typ	最大值 Max	单位 Unit
Peak Forward Voltage	V_{FM}	$I_F = 10A(T_C = 25^\circ C)$			0.8	V
		$I_F = 10A(T_C = 125^\circ C)$			0.7	V
		$I_F = 20A(T_C = 125^\circ C)$			0.95	V
		$I_F = 20A(T_C = 125^\circ C)$			0.85	V
Instantaneous Reverse Current	I_{RM}	$V_R = 100V(T_C = 25^\circ C)$			0.15	mA
		$V_R = 100V(T_C = 125^\circ C)$			150	mA
Voltage Rate of Change	dv/dt				10000	V/ μ s

电参数曲线图 / Electrical Characteristic Curve

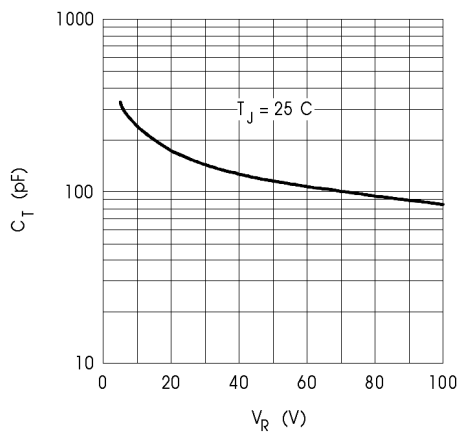
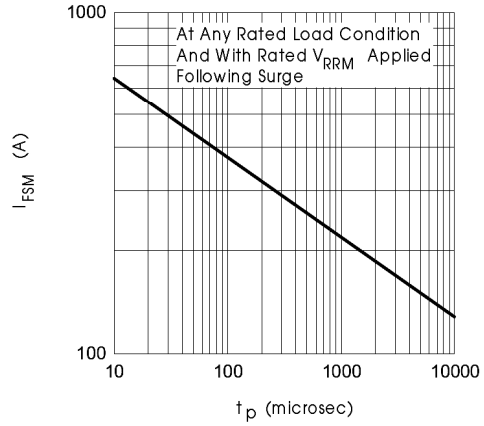
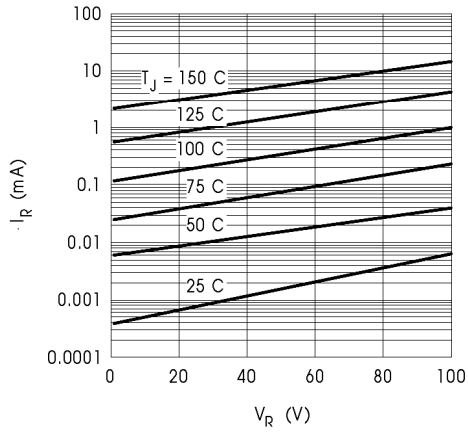
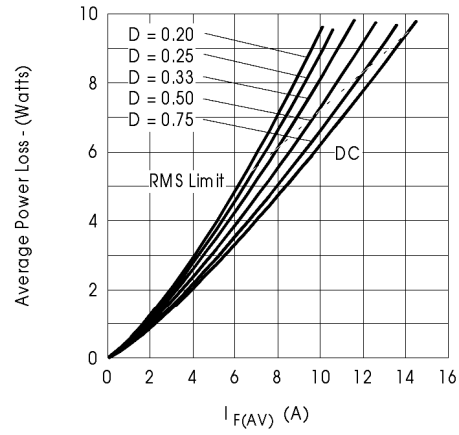
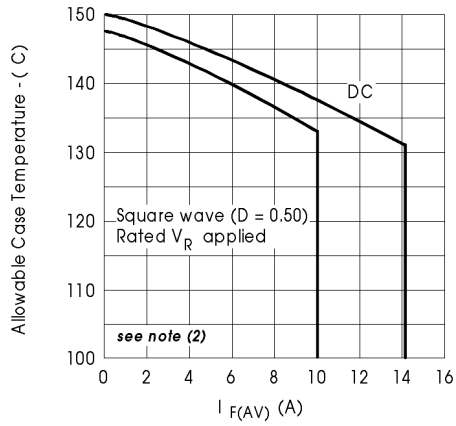

外形尺寸图 / Package Dimensions

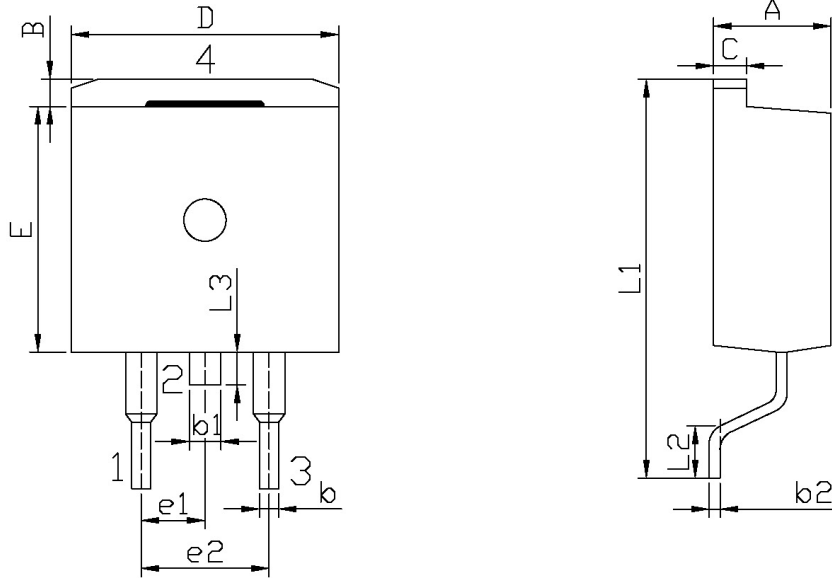

单位: mm

Symbol	Dimensions In Millimeters		Symbol	Dimensions In Millimeters	
	Min	Max		Min	Max
A	4.30	4.70	E	9.00	9.40
B	1.00	1.40	e1	2.34	2.74
b	0.70	0.90	e2	4.88	5.28
b1	1.15	1.35	L1	15.00	16.00
b2	0.40	0.60	L2	2.24	2.84
C	1.20	1.40	L3	1.20	1.60
D	9.80	10.20			

T0-263

印章说明 / Marking Instructions

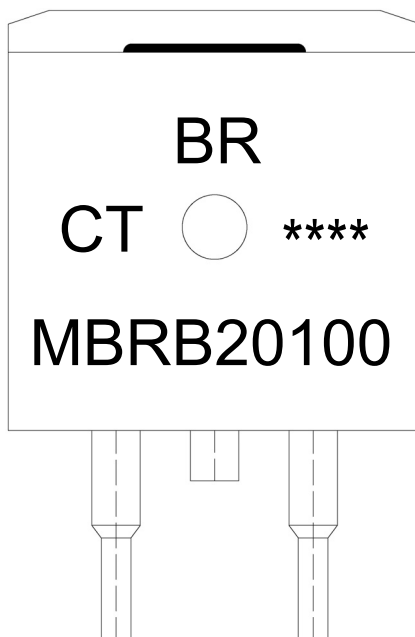

说明：

BR： 为公司代码

MBRB20100： 为产品型号

CT： 为内部结构

****： 为生产批号代码，随生产批号变化。

Note:

BR: Company Code

MBRB20100 : Product Type.

CT: Internal Structure

****: Lot No. Code, code change with Lot No.

回流焊温度曲线图(无铅) / Temperature Profile for IR Reflow Soldering(Pb-Free)



说明：

- 1、预热温度 25~150°C，时间 60~90sec;
- 2、峰值温度 245±5°C，时间持续为 5±0.5sec;
- 3、焊接制程冷却速度为 2~10°C/sec.

Note:

- 1.Preheating:25~150°C, Time:60~90sec.
- 2.Peak Temp.:245±5°C, Duration:5±0.5sec.
3. Cooling Speed: 2~10°C/sec.

耐焊接热试验条件 / Resistance to Soldering Heat Test Conditions

温度：260±5°C

时间：10±1 sec.

Temp.:260±5°C

Time:10±1 sec

包装规格 / Packaging SPEC.

卷盘包装 / REEL

Package Type 封装形式	Units 包装数量					Dimension 包装尺寸 (unit: mm ³)		
	Units/Reel 只/卷盘	Reels/Inner Box 卷盘/盒	Units/Inner Box 只/盒	Inner Boxes/Outer Box 盒/箱	Units/Outer Box 只/箱	Reel	Inner Box 盒	Outer Box 箱
TO-263	800	1	800	5	4,000	13" x24	360×360×50	385×257×392

套管包装 / TUBE

Package Type 封装形式	Units 包装数量					Dimension 包装尺寸 (unit: mm ³)		
	Units/Tube 只/套管	Tubes/Inner Box 套管/盒	Units/Inner Box 只/盒	Inner Boxes/Outer Box 盒/箱	Units/Outer Box 只/箱	Tube 套管	Inner Box 盒	Outer Box 箱
TO-263	50	20	1,000	5	5,000	532×33×7.0	555×164×50	575×290×180

使用说明 / Notices