

Main Product Characteristics

$I_{F(AV)}$	2 X 5A
V_{RWM}	45V
T_J	150°C

Features

- Low forward voltage drop.
- Excellent high temperature stability.
- Fast switching capability.
- Suffix "G" indicates Halogen-free part.
- Lead free in compliance with EU RoHS.

Mechanical data

- Epoxy : UL94V-0 flame retardant.
- Case : JEDEC TO-220AB-J molded plastic body.
- Terminals : Solder plated, solderable per MIL-STD-750, Method 2026.
- Polarity : As marked.
- Weight : Approximated 1.95 gram.

Outline

ITO-220AB-J

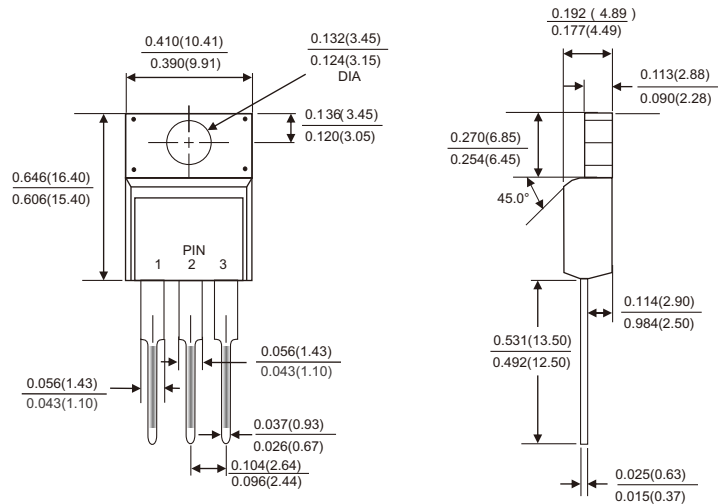

Dimensions in inches and (millimeters)

Maximum ratings and electrical characteristics

Rating at 25°C ambient temperature unless otherwise specified.

Circuit Diagram

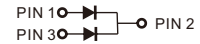

Parameter	Conditions	Symbol	MBRF1045CT-D-J	UNIT
Working peak reverse voltage		V_{RWM}	45	V
Forward rectified current (total device)		I_O	10	A
Forward surge current (per diode)	8.3ms single half sine-wave superimposed on rate load (JEDEC method)	I_{FSM}	125	A
Typical Thermal resistance(per diode)	Junction to case	$R_{\theta JC}$	2	°C/W
	Junction to Ambient	$R_{\theta JA}$	50	°C/W
Storage temperature		T_{STG}	-55 ~ +150	°C
Operating Junction temperature		T_J	-55 ~ +150	°C

Parameter	Conditions	Symbol	MIN.	TYP.	MAX.	UNIT
Forward voltage drop (per diode)	$I_F = 5A, T_J = 25^\circ C$	V_F			700	mV
	$I_F = 5A, T_J = 125^\circ C$				600	
Reverse current (per diode)	$V_R = 45V, T_J = 25^\circ C$	I_R			0.1	mA
	$V_R = 45V, T_J = 125^\circ C$				20	
Reverse Breakdown Voltage (per diode)	$I_R = 0.5mA, T_J = 25^\circ C$	V_{BR}	45			V

Rating and characteristic curves

Fig. 1 - Forward Characteristics

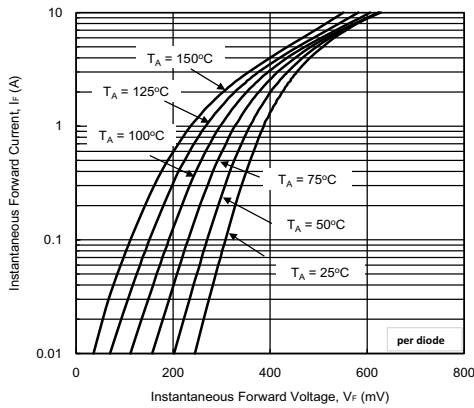

Fig. 2 - Reverse Characteristics

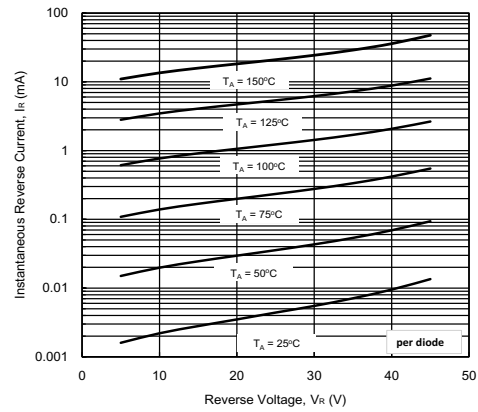

Fig. 3 - Forward Power Dissipation

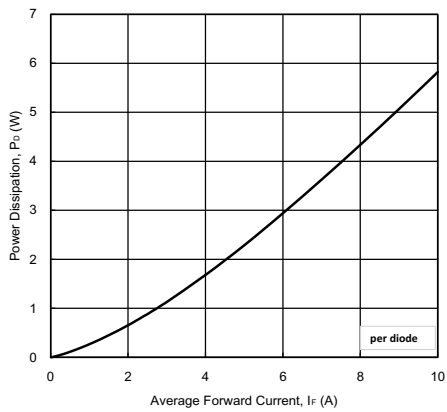

Fig. 4 - Forward Current Derating Curve

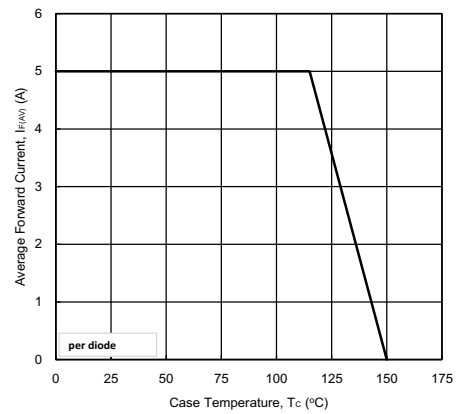
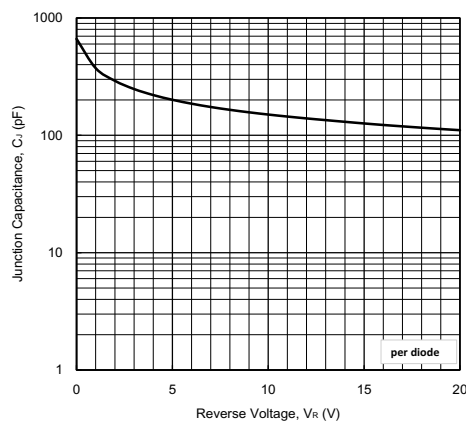
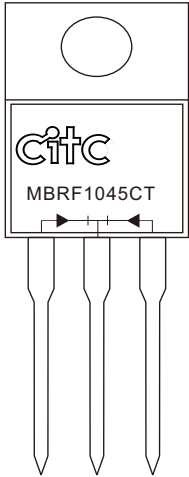



Fig. 5 - Junction Capacitance



■ Marking information



MBRF1045CT : Product type marking code

 : CITC Logo

■ Ordering/Packing information

	Part number	Case	Q'TY/Tube (PCS)	Q'TY/Box (PCS)	Q'TY/Carton (PCS)
Halogen	MBRF1045CT-D-J	ITO-220AB-J	50	1000	5000
Halogen free	MBRF1045CTG-D-J				

Notes : 1. For packaging details please reference our website at <http://www.citcorp.com.tw/tchinese/products/index.php>

- CITC reserves the right to make changes to this document and its products and specifications at any time without notice.
- Customers should obtain and confirm the latest product information and specifications before final design, purchase or use.
- CITC makes no warranty, representation or guarantee regarding the suitability of its products for any particular purpose, nor does CITC assume any liability for application assistance or customer product design.
- CITC does not warrant or accept any liability with products which are purchased or used for any unintended or unauthorized application.
- No license is granted by implication or otherwise under any intellectual property rights of CITC.
- CITC products are not authorized for use as critical components in life support devices or systems without express written approval of CITC.