

Schottky Diodes MBRF20100CT

■ Features

- Low forward voltage drop
- High frequency properties and switching speed
- Guard ring for over-voltage protection

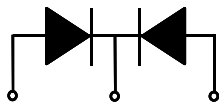

1. Anode 2.Cathode 3. Anode

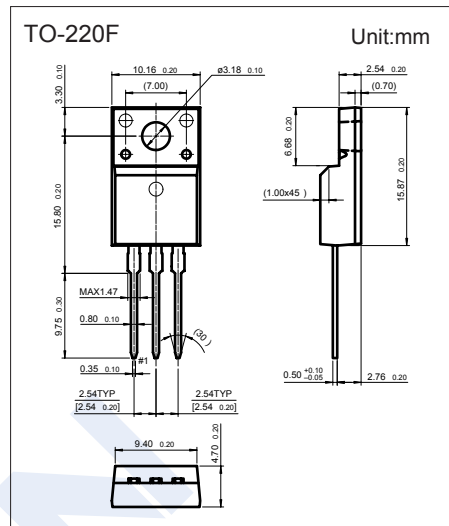

■ Absolute Maximum Ratings Ta = 25°C

Parameter	Symbol	Rating	Unit
Repetitive Reverse Voltage	VRRM	100	V
DC Reverse Voltage	VR	100	
DC Forward Current Tc = 105°C	IF(AV)	20	A
Peak forward surge current @ 60Hz Sine Half-Sine Wave	IFSM	150	
Thermal Resistance, Junction to Case (per diode)	RθJC	2.8	°C/W
Junction Temperature	TJ	150	°C
Storage temperature range	Tstg	-65 to 150	

■ Electrical Characteristics Ta = 25°C

Parameter	Symbol	Test Conditions	Min	Typ	Max	Unit
Reverse breakdown voltage	V _{RM}	I _D = 200uA	100			V
Forward voltage (Note.1)	V _F	I _F = 10 A , T _c = 25°C			770	mV
		I _F = 10 A , T _c = 125°C			650	
		I _F = 20 A , T _c = 25°C			950	
		I _F = 20 A , T _c = 125°C			750	
Reverse voltage leakage current (Note.1)	I _R	T _c = 25 °C			0.1	mA
		T _c = 125 °C			20	

Note.1: Pulse Test: Pulse Width=300µs, Duty Cycle=2%

Schottky Diodes

MBRF20100CT

■ Typical Characteristics

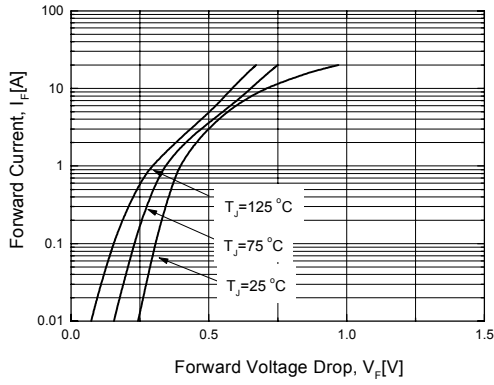

Figure 1. Typical Forward Voltage Characteristics (per diode)

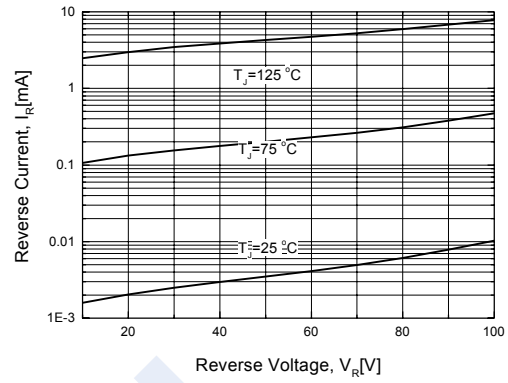

Figure 2. Typical Reverse Current vs. Reverse Voltage (per diode)

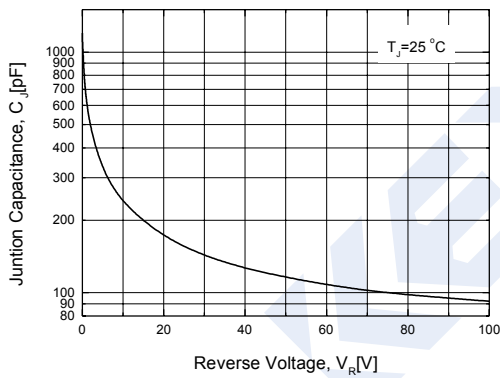

Figure 3. Typical Junction Capacitance (per diode)

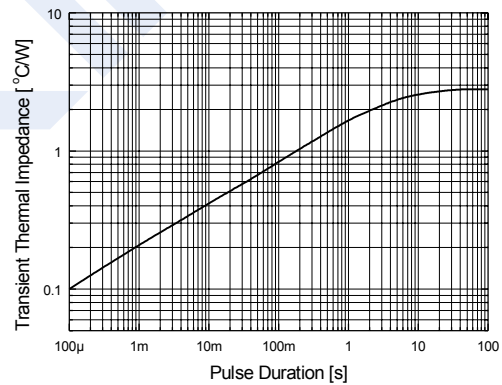

Figure 4. Thermal Impedance Characteristics (per diode)

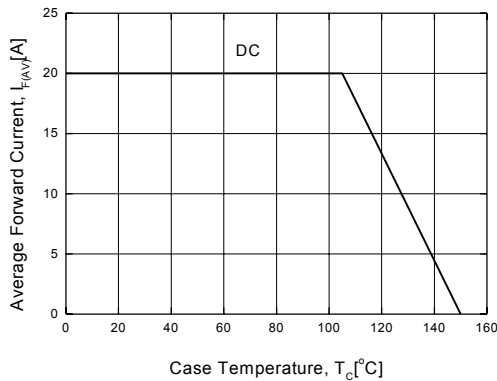

Figure 5. Forward Current Derating Curve

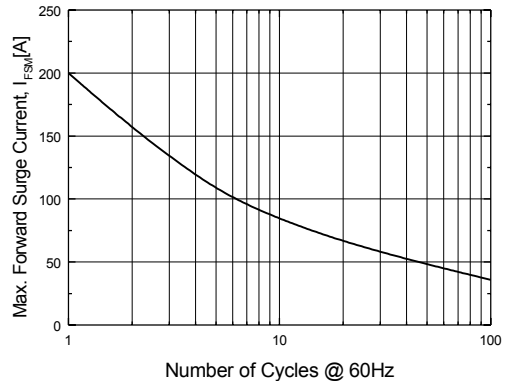

Figure 6. Non-Repetitive Surge Current (per diode)