

描述 / Descriptions

TO-251 塑封封装 肖特基二极管。

Schottky Barrier Diode in a TO-251 Plastic Package.

特征 / Features

损耗低，效率高。

Low power loss, high efficiency.

用途 / Applications

用于高频、低压、大电流整流二极管，续流二极管，保护二极管。

For use in low voltage, high frequency inverters, free wheeling, and polarity protection applications.

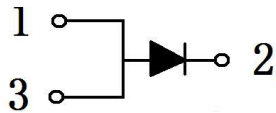
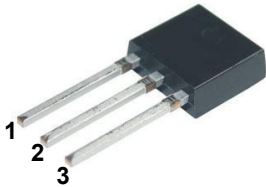
内部等效电路 / Equivalent Circuit**引脚排列 / Pinning**

PIN1 : Anode

PIN 2 : Cathode

PIN 3 : Anode

放大及印章代码 / h_{FE} Classifications & Marking

见印章说明。 See Marking Instructions.

极限参数 / Absolute Maximum Ratings(Ta=25°C)

参数 Parameter	符号 Symbol	数值 Rating	单位 Unit
Peak Repetitive Reverse Voltage Working Peak Reverse Voltage	V_{RRM} V_{RWM}	45	V
Reverse Voltage	V_R	45	V
Average Rectified Forward Current	$I_{F(AV)}$	10	A
Non Repetitive Peak Surge Current	I_{FSM}	100	A
Junction Temperature Range	T_j	150	°C
Storage Temperature Range	T_{stg}	-65~150	°C

电性能参数 / Electrical Characteristics(Ta=25°C)

参数 Parameter	符号 Symbol	测试条件 Test Conditions	最小值 Min	典型值 Typ	最大值 Max	单位 Unit
Reverse Voltage	V_R	$I_R = 1mA$	45			V
Peak Forward Voltage	V_{FM}	$I_F = 5A(T_C = 25°C)$		0.41	0.49	V
		$I_F = 5A(T_C = 125°C)$		0.37	0.41	V
		$I_F = 10A(T_C = 25°C)$		0.47	0.55	V
Instantaneous Reverse Current	I_{RM}	$V_R = 40V(T_C = 25°C)$			0.50	mA
		$V_R = 40V(T_C = 125°C)$			50	mA
Voltage Rate of Change	dv/dt				10000	V/μs

电参数曲线图 / Electrical Characteristic Curve

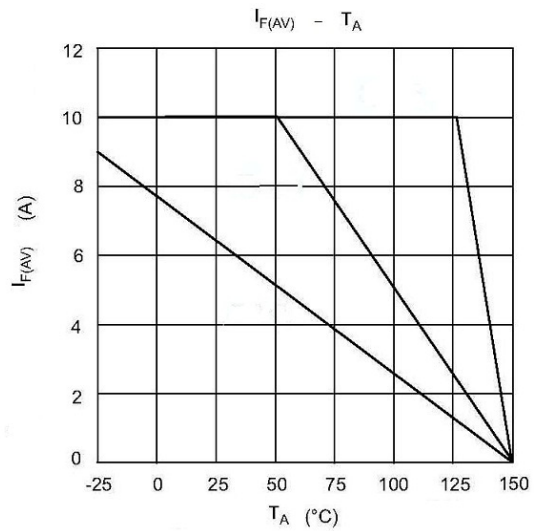
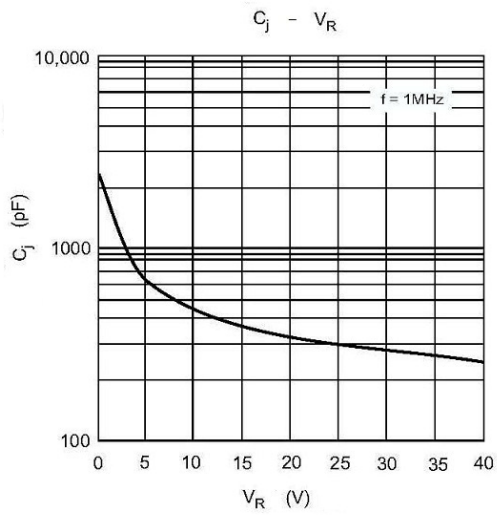
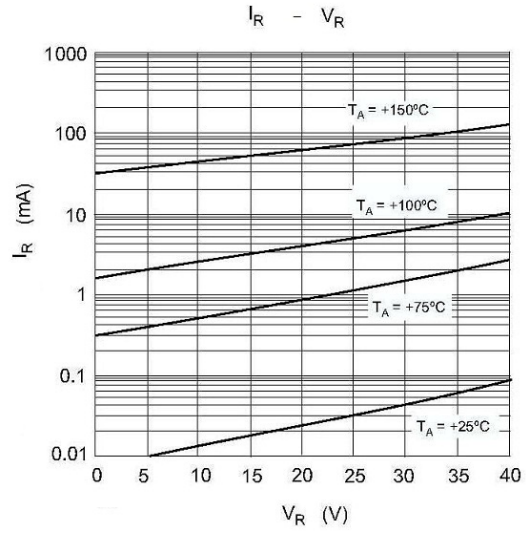
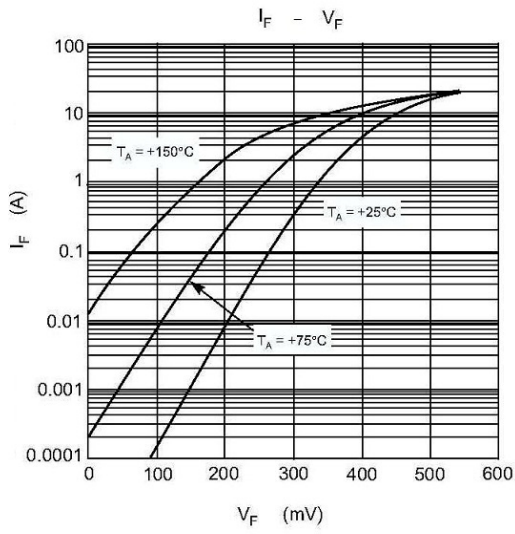

外形尺寸图 / Package Dimensions

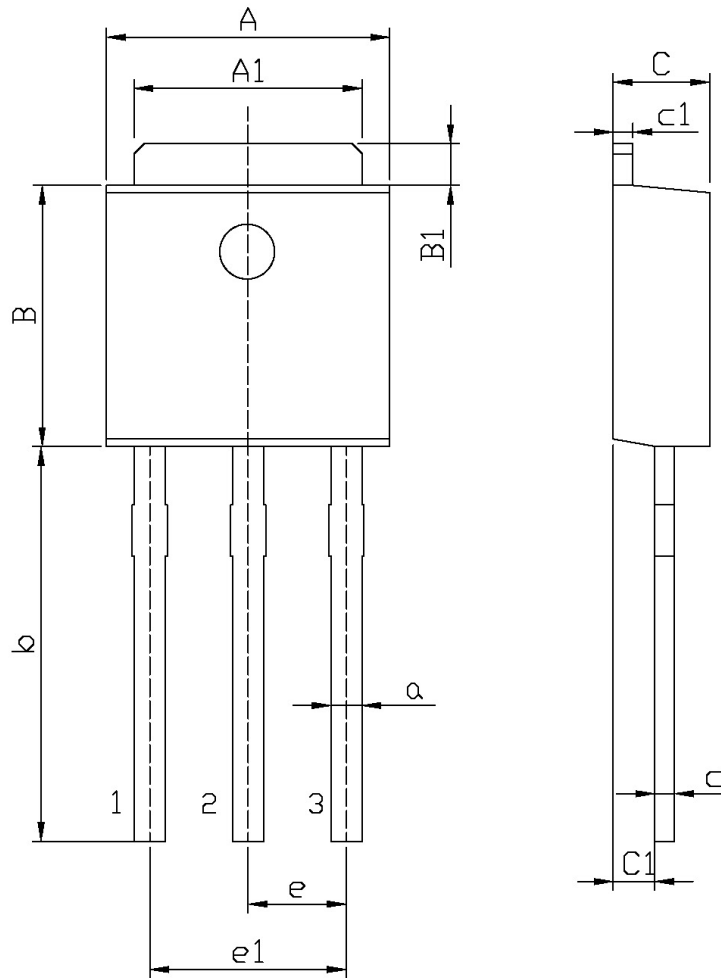

单位: mm

Symbol	Dimensions In Millimeters		Symbol	Dimensions In Millimeters	
	Min	Max		Min	Max
A	6.45	6.75	a	0.50	0.70
A1	5.10	5.50	b	9.00	9.40
B	5.95	6.25	c	0.45	0.55
B1	0.95	1.25	c1	0.45	0.55
C	2.20	2.40	e	2.24	2.34
C1	0.95	1.15	e1	4.43	4.73

TO-251

印章说明 / Marking Instructions

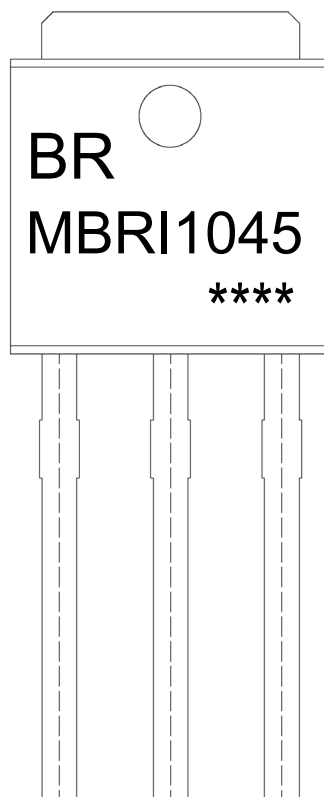

说明：

BR： 为公司代码

MBRI1045： 为产品型号

****： 为生产批号代码，随生产批号变化。

Note:

BR: Company Code

MBRI1045： Product Type.

****: Lot No. Code, code change with Lot No.

波峰焊温度曲线图(无铅) / Temperature Profile for Dip Soldering(Pb-Free)



说明：

- 1、预热温度 25 ~ 150°C，时间 60 ~ 90sec;
- 2、峰值温度 255±5°C，时间持续为 5±0.5sec;
- 3、焊接制程冷却速度为 2 ~ 10°C/sec.

Note:

- 1.Preheating:25~150°C, Time:60~90sec.
- 2.Peak Temp.:255±5°C, Duration:5±0.5sec.
3. Cooling Speed: 2~10°C/sec.

耐焊接热试验条件 / Resistance to Soldering Heat Test Conditions

温度：270±5°C

时间：10±1 sec.

Temp.:270±5°C

Time:10±1 sec

包装规格 / Packaging SPEC.

散件包装 / BULK

Package Type 封装形式	Units 包装数量					Dimension 包装尺寸 (unit: mm ³)		
	Units/Bag 只/袋	Bags/Inner Box 袋/盒	Units/Inner Box 只/盒	Inner Boxes/Outer Box 盒/箱	Units/Outer Box 只/箱	Bag 袋	Inner Box 盒	Outer Box 箱
TO-251	1,000	10	10,000	5	50,000	135×190	237×172×102	560×245×195

套管包装 / TUBE

Package Type 封装形式	Units 包装数量					Dimension 包装尺寸 (unit: mm ³)		
	Units/Tube 只/套管	Tubes/Inner Box 套管/盒	Units/Inner Box 只/盒	Inner Boxes/Outer Box 盒/箱	Units/Outer Box 只/箱	Tube 套管	Inner Box 盒	Outer Box 箱
TO-251/252	75	48	3,600	5	18,000	526×20.5×5.25	555×164×50	575×290×180

使用说明 / Notices