

MBT35200MT1

High Current Surface Mount PNP Silicon Switching Transistor for Load Management in Portable Applications

A Device of the μX^{TM} Family



ON Semiconductor

<http://onsemi.com>

35 VOLTS
2.0 AMPS
PNP TRANSISTOR

MAXIMUM RATINGS ($T_A = 25^{\circ}\text{C}$)

Rating	Symbol	Max	Unit
Collector-Emitter Voltage	V_{CEO}	-35	Vdc
Collector-Base Voltage	V_{CBO}	-55	Vdc
Emitter-Base Voltage	V_{EBO}	-5.0	Vdc
Collector Current — Continuous	I_{C}	-2.0	Adc
Collector Current — Peak	I_{CM}	-5.0	A
Electrostatic Discharge	ESD	HBM Class 3 MM Class C	

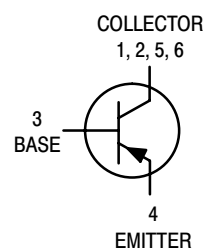

THERMAL CHARACTERISTICS

Characteristic	Symbol	Max	Unit
Total Device Dissipation $T_A = 25^{\circ}\text{C}$ Derate above 25°C	P_{D} (Note 1.)	625	mW
		5.0	mW/ $^{\circ}\text{C}$
Thermal Resistance, Junction to Ambient	$R_{\theta\text{JA}}$ (Note 1.)	200	$^{\circ}\text{C}/\text{W}$
Total Device Dissipation $T_A = 25^{\circ}\text{C}$ Derate above 25°C	P_{D} (Note 2.)	1.0	W
		8.0	mW/ $^{\circ}\text{C}$
Thermal Resistance, Junction to Ambient	$R_{\theta\text{JA}}$ (Note 2.)	120	$^{\circ}\text{C}/\text{W}$
Thermal Resistance, Junction to Lead #1	$R_{\theta\text{JL}}$	80	$^{\circ}\text{C}/\text{W}$
Total Device Dissipation (Single Pulse < 10 sec.)	P_{Dsingle} (Notes 2. & 3.)	1.75	W
Junction and Storage Temperature Range	$T_{\text{J}}, T_{\text{stg}}$	-55 to +150	$^{\circ}\text{C}$

- FR-4 @ Minimum Pad
- FR-4 @ 1.0 X 1.0 inch Pad
- ref: Figure 9

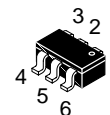

CASE 318G
TSOP
STYLE 6

DEVICE MARKING

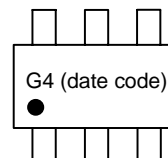

ORDERING INFORMATION

Device	Package	Shipping
MBT35200MT1	Case 318G	3000/Tape & Reel

MBT35200MT1

ELECTRICAL CHARACTERISTICS (T_A = 25°C unless otherwise noted)

Characteristic	Symbol	Min	Typical	Max	Unit
OFF CHARACTERISTICS					
Collector–Emitter Breakdown Voltage (I _C = –10 mAdc, I _B = 0)	V _{(BR)CEO}	–35	–45	—	Vdc
Collector–Base Breakdown Voltage (I _C = –0.1 mAdc, I _E = 0)	V _{(BR)CBO}	–55	–65	—	Vdc
Emitter–Base Breakdown Voltage (I _E = –0.1 mAdc, I _C = 0)	V _{(BR)EBO}	–5.0	–7.0	—	Vdc
Collector Cutoff Current (V _{CB} = –35 Vdc, I _E = 0)	I _{CBO}	—	–0.03	–0.1	μAdc
Collector–Emitter Cutoff Current (V _{CES} = –35 Vdc)	I _{CES}	—	–0.03	–0.1	μAdc
Emitter Cutoff Current (V _{EB} = –4.0 Vdc)	I _{EBO}	—	–0.01	–0.1	μAdc
ON CHARACTERISTICS					
DC Current Gain ⁽¹⁾ (I _C = –1.0 A, V _{CE} = –1.5 V) (I _C = –1.5 A, V _{CE} = –1.5 V) (I _C = –2.0 A, V _{CE} = –3.0 V)	h _{FE}	100 100 100	200 200 200	— 400 —	
Collector–Emitter Saturation Voltage (Note 4.) (I _C = –0.8 A, I _B = –0.008 A) (I _C = –1.2 A, I _B = –0.012 A) (I _C = –2.0 A, I _B = –0.02 A)	V _{CE(sat)}	— — —	–0.125 –0.175 –0.260	–0.15 –0.20 –0.31	V
Base–Emitter Saturation Voltage (Note 4.) (I _C = –1.2 A, I _B = –0.012 A)	V _{BE(sat)}	—	–0.68	–0.85	V
Base–Emitter Turn–on Voltage (Note 4.) (I _C = –2.0 A, V _{CE} = –3.0 V)	V _{BE(on)}	—	–0.81	–0.875	V
Cutoff Frequency (I _C = –100 mA, V _{CE} = –5.0 V, f = 100 MHz)	f _T	100	—	—	MHz
Input Capacitance (V _{EB} = –0.5 V, f = 1.0 MHz)	C _{ibo}	—	600	650	pF
Output Capacitance (V _{CB} = –3.0 V, f = 1.0 MHz)	C _{obo}	—	85	100	pF
Turn–on Time (V _{CC} = –10 V, I _{B1} = –100 mA, I _C = –1 A, R _L = 3 Ω)	t _{on}	—	35	—	nS
Turn–off Time (V _{CC} = –10 V, I _{B1} = I _{B2} = –100 mA, I _C = 1 A, R _L = 3 Ω)	t _{off}	—	225	—	nS

4. Pulsed Condition: Pulse Width = 300 μsec, Duty Cycle ≤ 2%

MBT35200MT1

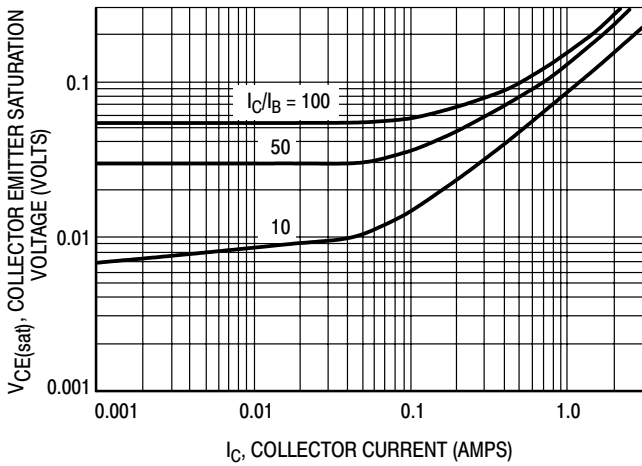

Figure 1. Collector Emitter Saturation Voltage versus Collector Current

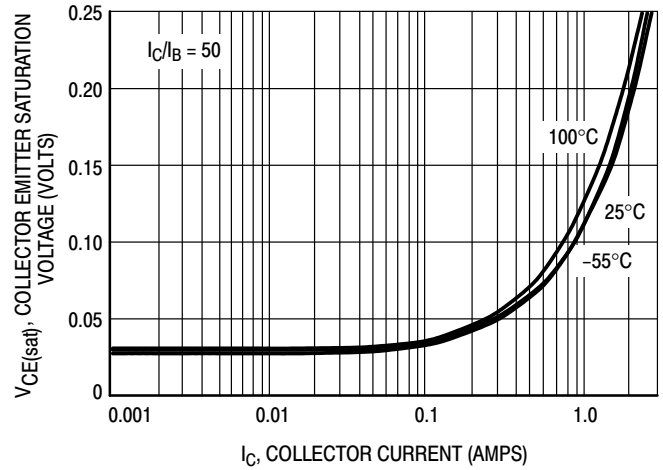

Figure 2. Collector Emitter Saturation Voltage versus Collector Current

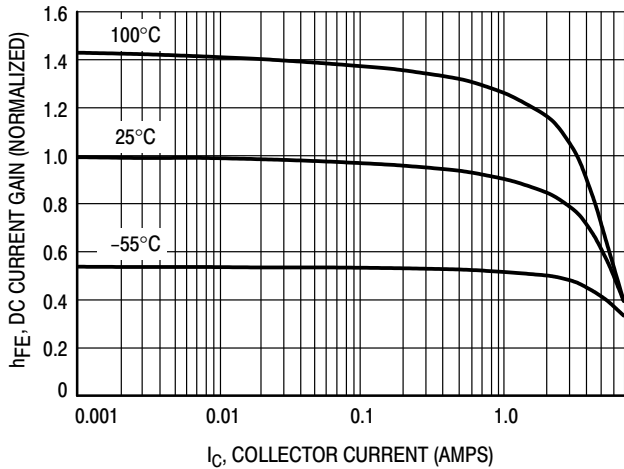

Figure 3. DC Current Gain versus Collector Current

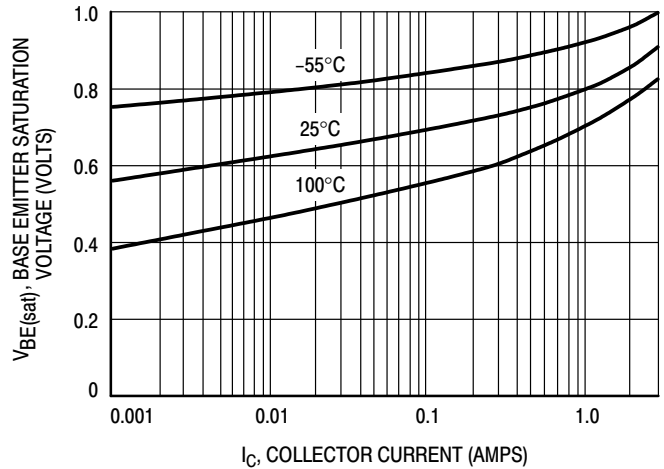

Figure 4. Base Emitter Saturation Voltage versus Collector Current

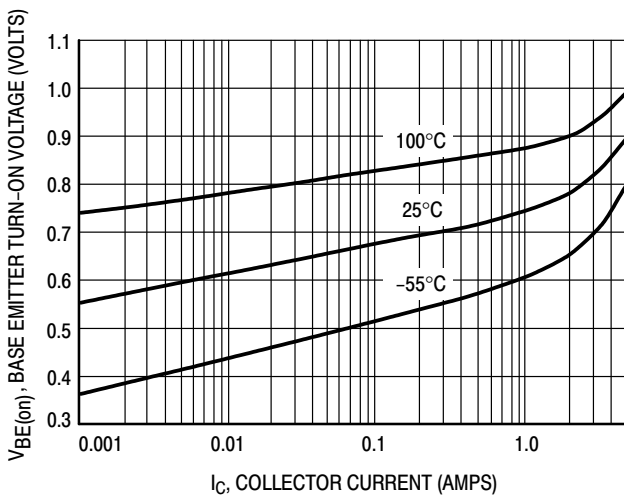

Figure 5. Base Emitter Turn-On Voltage versus Collector Current

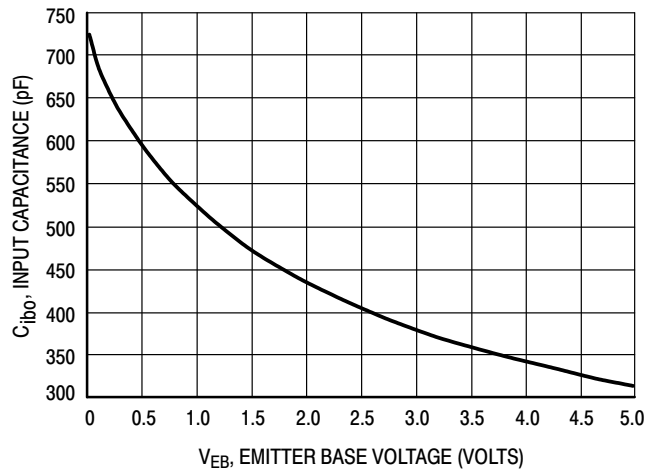

Figure 6. Input Capacitance

MBT35200MT1

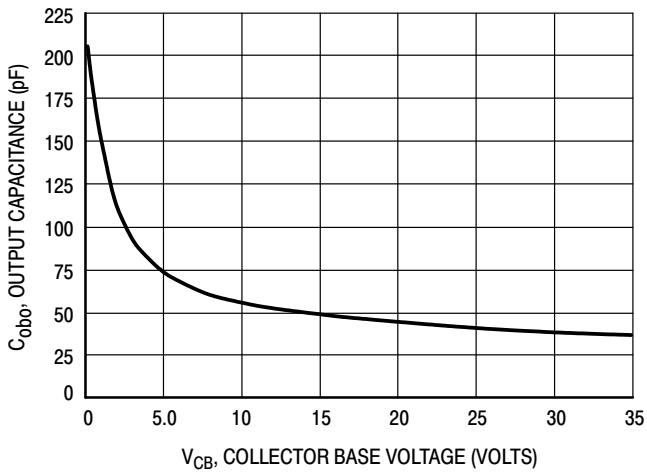

Figure 7. Output Capacitance

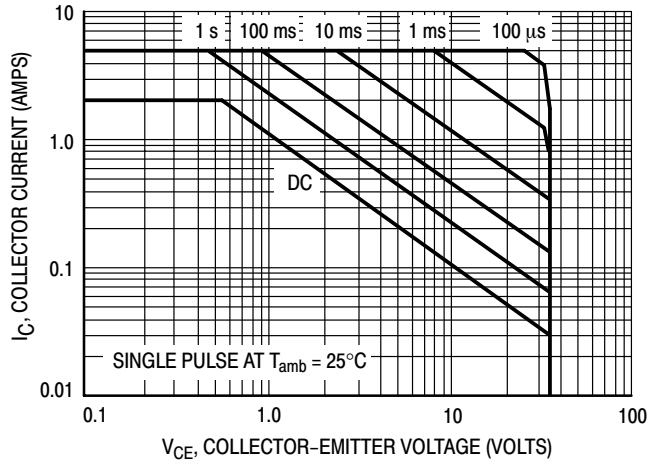

Figure 8. Safe Operating Area

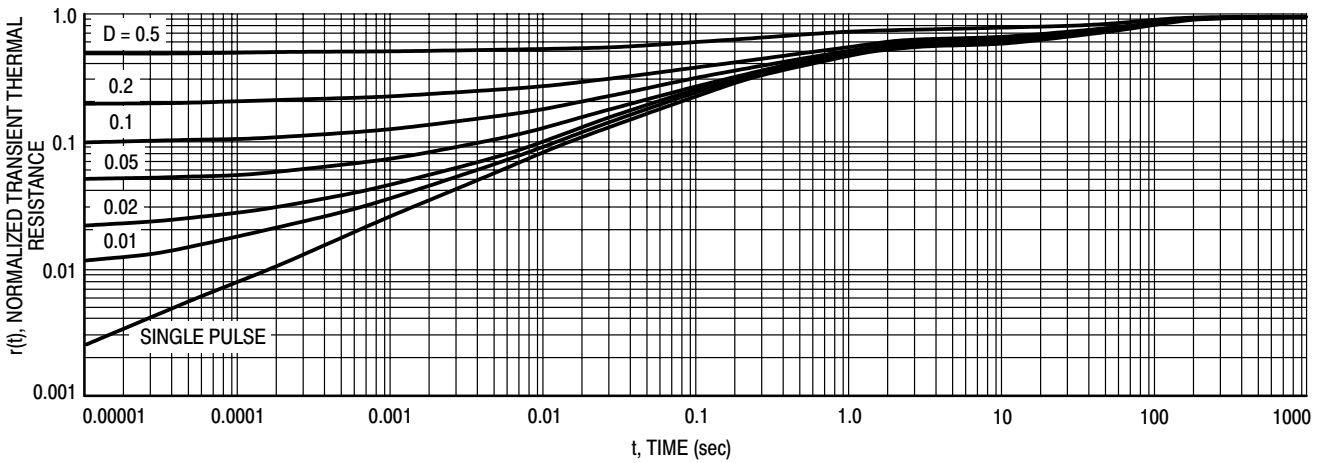

Figure 9. Normalized Thermal Response

INFORMATION FOR USING THE TSOP-6 SURFACE MOUNT PACKAGE

MINIMUM RECOMMENDED FOOTPRINT FOR SURFACE MOUNTED APPLICATIONS

Surface mount board layout is a critical portion of the total design. The footprint for the semiconductor packages must be the correct size to insure proper solder connection

interface between the board and the package. With the correct pad geometry, the packages will self align when subjected to a solder reflow process.

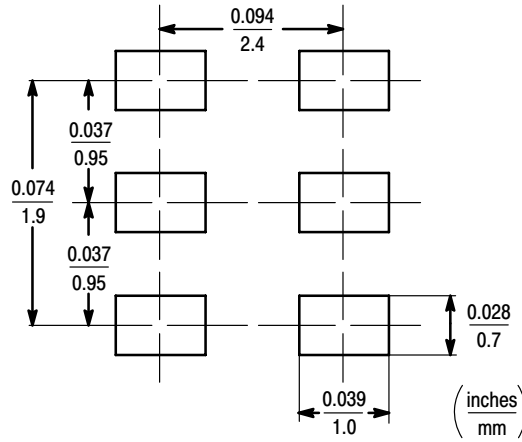

TSOP-6

TSOP-6 POWER DISSIPATION

The power dissipation of the TSOP-6 is a function of the drain pad size. This can vary from the minimum pad size for soldering to a pad size given for maximum power dissipation. Power dissipation for a surface mount device is determined by $T_{J(max)}$, the maximum rated junction temperature of the die, $R_{\theta JA}$, the thermal resistance from the device junction to ambient, and the operating temperature, T_A . Using the values provided on the data sheet for the TSOP-6 package, P_D can be calculated as follows:

$$P_D = \frac{T_{J(max)} - T_A}{R_{\theta JA}}$$

The values for the equation are found in the maximum ratings table on the data sheet. Substituting these values into the equation for an ambient temperature T_A of 25°C, one can calculate the power dissipation of the device which in this case is 625 milliwatts.

$$P_D = \frac{150^\circ\text{C} - 25^\circ\text{C}}{200^\circ\text{C/W}} = 625 \text{ milliwatts}$$

The 200°C/W for the TSOP-6 package assumes the use of the recommended footprint on a glass epoxy printed circuit board to achieve a power dissipation of 625 milliwatts. There are other alternatives to achieving higher power dissipation from the TSOP-6 package. Another alternative would be to use a ceramic substrate or an aluminum core board such as Thermal Clad™. Using a board material such as Thermal Clad, an aluminum core board, the power dissipation can be doubled using the same footprint.

SOLDERING PRECAUTIONS

The melting temperature of solder is higher than the rated temperature of the device. When the entire device is heated to a high temperature, failure to complete soldering within a short time could result in device failure. Therefore, the following items should always be observed in order to minimize the thermal stress to which the devices are subjected.

- Always preheat the device.
- The delta temperature between the preheat and soldering should be 100°C or less.*
- When preheating and soldering, the temperature of the leads and the case must not exceed the maximum temperature ratings as shown on the data sheet. When using infrared heating with the reflow soldering method, the difference shall be a maximum of 10°C.
- The soldering temperature and time shall not exceed 260°C for more than 10 seconds.
- When shifting from preheating to soldering, the maximum temperature gradient shall be 5°C or less.
- After soldering has been completed, the device should be allowed to cool naturally for at least three minutes. Gradual cooling should be used as the use of forced cooling will increase the temperature gradient and result in latent failure due to mechanical stress.
- Mechanical stress or shock should not be applied during cooling.

* Soldering a device without preheating can cause excessive thermal shock and stress which can result in damage to the device.

MBT35200MT1

PACKAGE DIMENSIONS

CASE 318G-02
ISSUE G

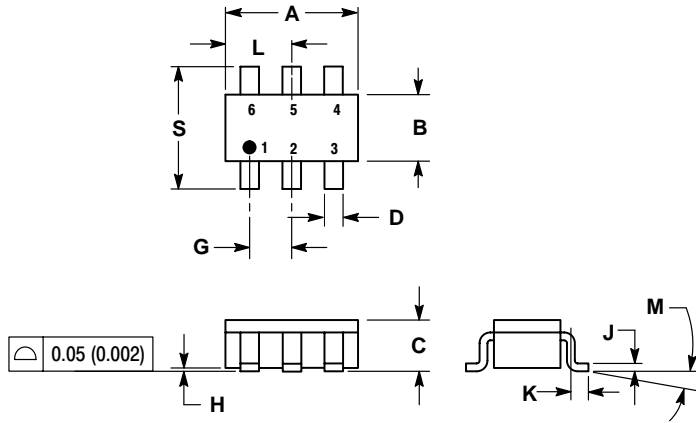

NOTES:

1. DIMENSIONING AND TOLERANCING PER ANSI Y14.5M, 1982.
2. CONTROLLING DIMENSION: MILLIMETER.
3. MAXIMUM LEAD THICKNESS INCLUDES LEAD FINISH THICKNESS. MINIMUM LEAD THICKNESS IS THE MINIMUM THICKNESS OF BASE MATERIAL.

DIM	MILLIMETERS		INCHES	
	MIN	MAX	MIN	MAX
A	2.90	3.10	0.1142	0.1220
B	1.30	1.70	0.0512	0.0669
C	0.90	1.10	0.0354	0.0433
D	0.25	0.50	0.0098	0.0197
G	0.85	1.05	0.0335	0.0413
H	0.013	0.100	0.0005	0.0040
J	0.10	0.26	0.0040	0.0102
K	0.20	0.60	0.0079	0.0236
L	1.25	1.55	0.0493	0.0610
M	0°	10°	0°	10°
S	2.50	3.00	0.0985	0.1181

STYLE 6:

- PIN 1. COLLECTOR
2. COLLECTOR
3. BASE
4. EMITTER
5. COLLECTOR
6. COLLECTOR

Notes

ON Semiconductor and  are trademarks of Semiconductor Components Industries, LLC (SCILLC). SCILLC reserves the right to make changes without further notice to any products herein. SCILLC makes no warranty, representation or guarantee regarding the suitability of its products for any particular purpose, nor does SCILLC assume any liability arising out of the application or use of any product or circuit, and specifically disclaims any and all liability, including without limitation special, consequential or incidental damages. "Typical" parameters which may be provided in SCILLC data sheets and/or specifications can and do vary in different applications and actual performance may vary over time. All operating parameters, including "Typicals" must be validated for each customer application by customer's technical experts. SCILLC does not convey any license under its patent rights nor the rights of others. SCILLC products are not designed, intended, or authorized for use as components in systems intended for surgical implant into the body, or other applications intended to support or sustain life, or for any other application in which the failure of the SCILLC product could create a situation where personal injury or death may occur. Should Buyer purchase or use SCILLC products for any such unintended or unauthorized application, Buyer shall indemnify and hold SCILLC and its officers, employees, subsidiaries, affiliates, and distributors harmless against all claims, costs, damages, and expenses, and reasonable attorney fees arising out of, directly or indirectly, any claim of personal injury or death associated with such unintended or unauthorized use, even if such claim alleges that SCILLC was negligent regarding the design or manufacture of the part. SCILLC is an Equal Opportunity/Affirmative Action Employer.

PUBLICATION ORDERING INFORMATION

NORTH AMERICA Literature Fulfillment:

Literature Distribution Center for ON Semiconductor
P.O. Box 5163, Denver, Colorado 80217 USA
Phone: 303-675-2175 or 800-344-3860 Toll Free USA/Canada
Fax: 303-675-2176 or 800-344-3867 Toll Free USA/Canada
Email: ONlit@hibbertco.com
Fax Response Line: 303-675-2167 or 800-344-3810 Toll Free USA/Canada

N. American Technical Support: 800-282-9855 Toll Free USA/Canada

EUROPE: LDC for ON Semiconductor – European Support

German Phone: (+1) 303-308-7140 (Mon-Fri 2:30pm to 7:00pm CET)
Email: ONlit-german@hibbertco.com
French Phone: (+1) 303-308-7141 (Mon-Fri 2:00pm to 7:00pm CET)
Email: ONlit-french@hibbertco.com
English Phone: (+1) 303-308-7142 (Mon-Fri 12:00pm to 5:00pm GMT)
Email: ONlit@hibbertco.com

EUROPEAN TOLL-FREE ACCESS*: 00-800-4422-3781

*Available from Germany, France, Italy, UK, Ireland

CENTRAL/SOUTH AMERICA:

Spanish Phone: 303-308-7143 (Mon-Fri 8:00am to 5:00pm MST)
Email: ONlit-spanish@hibbertco.com

ASIA/PACIFIC: LDC for ON Semiconductor – Asia Support

Phone: 303-675-2121 (Tue-Fri 9:00am to 1:00pm, Hong Kong Time)
Toll Free from Hong Kong & Singapore:
001-800-4422-3781
Email: ONlit-asia@hibbertco.com

JAPAN: ON Semiconductor, Japan Customer Focus Center
4-32-1 Nishi-Gotanda, Shinagawa-ku, Tokyo, Japan 141-0031

Phone: 81-3-5740-2700
Email: r14525@onsemi.com

ON Semiconductor Website: <http://onsemi.com>

For additional information, please contact your local Sales Representative.