

Product Preview

Low-Voltage 1:20 Differential ECL/PECL Clock Driver

The MC100EP221 is a low skew 1-to-20 differential driver, designed with clock distribution in mind. It accepts two clock sources into an input multiplexer. The input signals can be either differential or single-ended if the V_{BB} output is used. The selected signal is fanned out to 20 identical differential outputs.

- 150ps Part-to-Part Skew
- 50ps Output-to-Output Skew
- Differential Design
- V_{BB} Output
- Voltage and Temperature Compensated Outputs
- Low Voltage V_{EE} Range of -2.375 to -3.8V
- 75k Ω Input Pulldown Resistors

The EP221 is specifically designed, modeled and produced with low skew as the key goal. Optimal design and layout serve to minimize gate-to-gate skew within a device, and empirical modeling is used to determine process control limits that ensure consistent t_{pd} distributions from lot to lot. The net result is a dependable, guaranteed low skew device.

To ensure that the tight skew specification is met it is necessary that both sides of the differential output are terminated into 50 Ω , even if only one side is being used. In most applications, all ten differential pairs will be used and therefore terminated. In the case where fewer than ten pairs are used, it is necessary to terminate at least the output pairs on the same package side as the pair(s) being used on that side, in order to maintain minimum skew. Failure to do this will result in small degradations of propagation delay (on the order of 10-20ps) of the output(s) being used which, while not being catastrophic to most designs, will mean a loss of skew margin.

The MC100EP221, as with most other ECL devices, can be operated from a positive V_{CC} supply in PECL mode. This allows the EP221 to be used for high performance clock distribution in +3.3V or +2.5V systems. Designers can take advantage of the EP221's performance to distribute low skew clocks across the backplane. In a PECL environment, series or Thevenin line terminations are typically used as they require no additional power supplies. For more information on using PECL, designers should refer to Motorola Application Note AN1406/D.

MC100EP221

**LOW-VOLTAGE
1:20 DIFFERENTIAL
ECL/PECL CLOCK DRIVER**

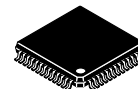

FA SUFFIX
52-LEAD TQFP PACKAGE
CASE 848D-03



Pinout: 52-Lead TQFP
(Top View)

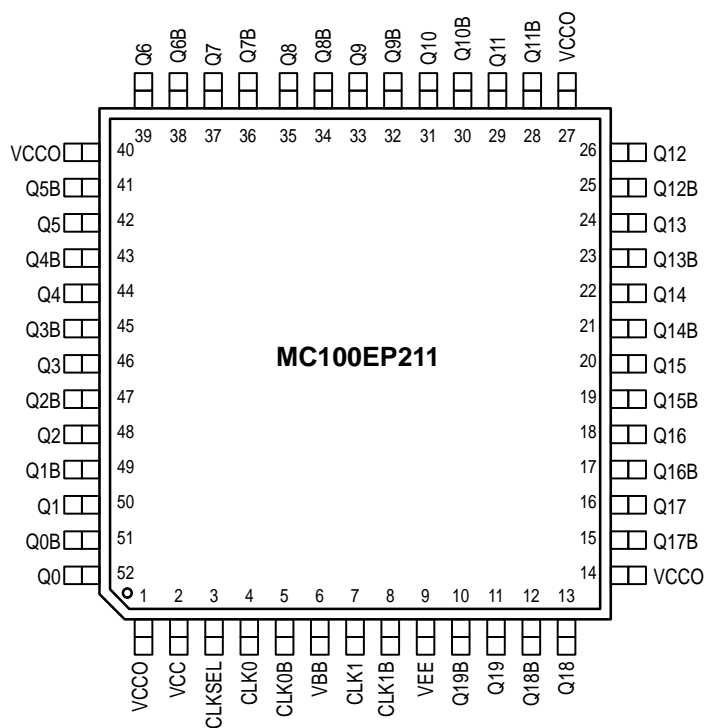

PIN NAMES

Pins	Function
CLKn, $\overline{\text{CLKn}}$	Differential Input Pairs
Q0:19, $\overline{\text{Q0:19}}$	Differential Outputs
CLK_SEL	Active Clock Select Input
VBB	V _{BB} Output

FUNCTION

CLK_SEL	Active Input
0	CLK0, $\overline{\text{CLK0}}$
1	CLK1, $\overline{\text{CLK1}}$

LOGIC SYMBOL

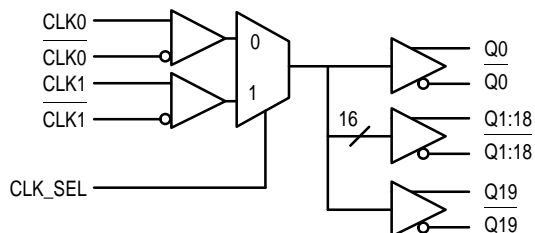

ECL DC CHARACTERISTICS

Symbol	Characteristic	-40°C			0°C			25°C			85°C			Unit
		Min	Typ	Max	Min	Typ	Max	Min	Typ	Max	Min	Typ	Max	
V _{OH}	Output HIGH Voltage	-1.025	-0.955	-0.880	-1.025	-0.955	-0.880	-1.025	-0.955	-0.880	-1.025	-0.955	-0.880	V
V _{OL}	Output LOW Voltage	-1.810	-1.705	-1.620	-1.810	-1.705	-1.620	-1.810	-1.705	-1.620	-1.810	-1.705	-1.620	V
V _{IH}	Input HIGH Voltage	-1.165		-0.880	-1.165		-0.880	-1.165		-0.880	-1.165		-0.880	V
V _{IL}	Input LOW Voltage	-1.810		-1.475	-1.810		-1.475	-1.810		-1.475	-1.810		-1.475	V
V _{BB}	Output Reference Voltage	-1.38		-1.26	-1.38		-1.26	-1.38		-1.26	-1.38		-1.26	V
V _{EE}	Power Supply Voltage	-2.375		-3.8	-2.375		-3.8	-2.375		-3.8	-2.375		-3.8	V
I _{IH}	Input HIGH Current			150			150			150			150	μA
I _{EE}	Power Supply Current													mA

PECL DC CHARACTERISTICS

Symbol	Characteristic	-40°C			0°C			25°C			85°C			Unit
		Min	Typ	Max	Min	Typ	Max	Min	Typ	Max	Min	Typ	Max	
V _{OH}	Output HIGH Voltage (NO TAG)	2.275	2.345	2.420	2.275	2.345	2.420	2.275	2.345	2.420	2.275	2.345	2.420	V
V _{OL}	Output LOW Voltage (NO TAG)	1.490	1.595	1.680	1.490	1.595	1.680	1.490	1.595	1.680	1.490	1.595	1.680	V
V _{IH}	Input HIGH Voltage (NO TAG)	2.135		2.420	2.135		2.420	2.135		2.420	2.135		2.420	V
V _{IL}	Input LOW Voltage (NO TAG)	1.490		1.825	1.490		1.825	1.490		1.825	1.490		1.825	V
V _{BB}	Output Reference Voltage (Note NO TAG)	1.92		2.04	1.92		2.04	1.92		2.04	1.92		2.04	V
V _{CC}	Power Supply Voltage	2.375		3.8	2.375		3.8	2.375		3.8	2.375		3.8	V
I _{IH}	Input HIGH Current			150			150			150			150	μA
I _{EE}	Power Supply Current													mA

1. These values are for V_{CC} = 3.3V. Level Specifications will vary 1:1 with V_{CC}.

AC CHARACTERISTICS (V_{EE} = V_{EE} (min) to V_{EE} (max); V_{CC} = V_{CCO} = GND)

Symbol	Characteristic	-40°C			0°C			25°C			85°C			Unit	Condition
		Min	Typ	Max	Min	Typ	Max	Min	Typ	Max	Min	Typ	Max		
t _{PLH} t _{PHL}	Propagation Delay to Output IN (differential) IN (single-ended)								500 500					ps	
t _{skew}	Within-Device Skew Part-to-Part Skew (Diff)		50 150			50 150			50 150			50 150		ps	
f _{max}	Maximum Input Frequency		1.5			1.5			1.5			1.5		GHz	
V _{PP}	Minimum Input Swing	500			500			500			500			mV	
V _{CMR}	Common Mode Range													V	
t _r /t _f	Output Rise/Fall Time		200			200			200			200		ps	20%–80%

OUTLINE DIMENSIONS

FA SUFFIX
PLASTIC TQFP PACKAGE
CASE 848D-03
ISSUE C

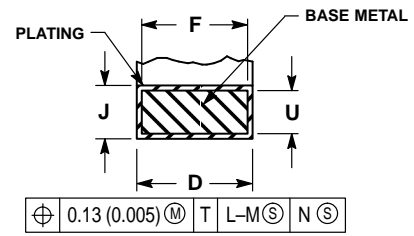
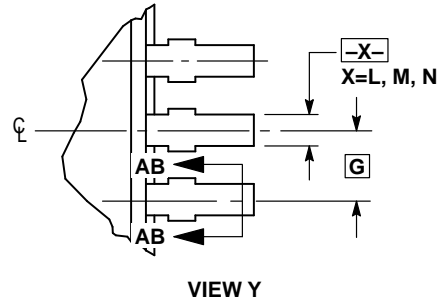
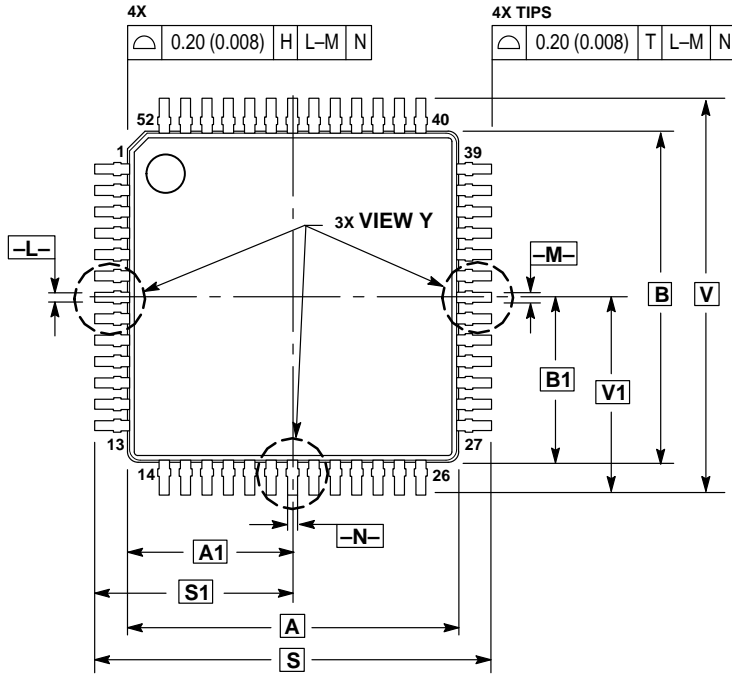

NOTES:

1. DIMENSIONING AND TOLERANCING PER ANSI Y14.5M, 1982.
2. CONTROLLING DIMENSION: MILLIMETER.
3. DATUM PLANE -H- IS LOCATED AT BOTTOM OF LEAD AND IS COINCIDENT WITH THE LEAD WHERE THE LEAD EXITS THE PLASTIC BODY AT THE BOTTOM OF THE PARTING LINE.
4. DATUMS -L-, -M- AND -N- TO BE DETERMINED AT DATUM PLANE -H-.
5. DIMENSIONS S AND V TO BE DETERMINED AT SEATING PLANE -T-.
6. DIMENSIONS A AND B DO NOT INCLUDE MOLD PROTRUSION. ALLOWABLE PROTRUSION IS 0.25 (0.010) PER SIDE. DIMENSIONS A AND B DO INCLUDE MOLD MISMATCH AND ARE DETERMINED AT DATUM PLANE -H-.
7. DIMENSION D DOES NOT INCLUDE DAMBAR PROTRUSION. DAMBAR PROTRUSION SHALL NOT CAUSE THE LEAD WIDTH TO EXCEED 0.46 (0.018). MINIMUM SPACE BETWEEN PROTRUSION AND ADJACENT LEAD OR PROTRUSION 0.07 (0.003).

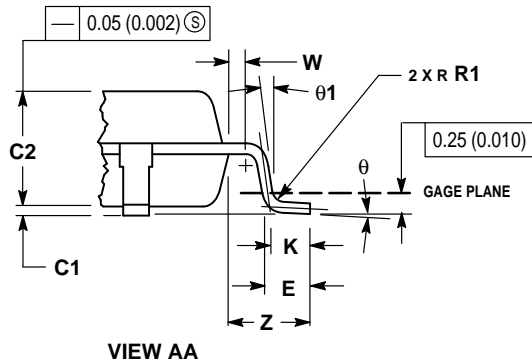
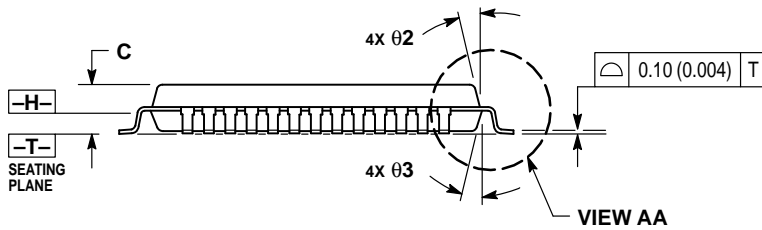

DIM	MILLIMETERS		INCHES	
	MIN	MAX	MIN	MAX
A	10.00 BSC	—	0.394 BSC	—
A1	5.00 BSC	—	0.197 BSC	—
B	10.00 BSC	—	0.394 BSC	—
B1	5.00 BSC	—	0.197 BSC	—
C	—	1.70	—	0.067
C1	0.05	0.20	0.002	0.008
C2	1.30	1.50	0.051	0.059
D	0.20	0.40	0.008	0.016
E	0.45	0.75	0.018	0.030
F	0.22	0.35	0.009	0.014
G	0.65 BSC	—	0.026 BSC	—
J	0.07	0.20	0.003	0.008
K	0.50 REF	—	0.020 REF	—
R1	0.08	0.20	0.003	0.008
S	12.00 BSC	—	0.472 BSC	—
S1	6.00 BSC	—	0.236 BSC	—
U	0.09	0.16	0.004	0.006
V	12.00 BSC	—	0.472 BSC	—
V1	6.00 BSC	—	0.236 BSC	—
W	0.20 REF	—	0.008 REF	—
Z	1.00 REF	—	0.039 REF	—
θ	0°	7°	0°	7°
Ø1	0°	—	0°	—
Ø2	12° REF	—	12° REF	—
Ø3	5°	13°	5°	13°

Motorola reserves the right to make changes without further notice to any products herein. Motorola makes no warranty, representation or guarantee regarding the suitability of its products for any particular purpose, nor does Motorola assume any liability arising out of the application or use of any product or circuit, and specifically disclaims any and all liability, including without limitation consequential or incidental damages. "Typical" parameters which may be provided in Motorola data sheets and/or specifications can and do vary in different applications and actual performance may vary over time. All operating parameters, including "Typicals" must be validated for each customer application by customer's technical experts. Motorola does not convey any license under its patent rights nor the rights of others. Motorola products are not designed, intended, or authorized for use as components in systems intended for surgical implant into the body, or other applications intended to support or sustain life, or for any other application in which the failure of the Motorola product could create a situation where personal injury or death may occur. Should Buyer purchase or use Motorola products for any such unintended or unauthorized application, Buyer shall indemnify and hold Motorola and its officers, employees, subsidiaries, affiliates, and distributors harmless against all claims, costs, damages, and expenses, and reasonable attorney fees arising out of, directly or indirectly, any claim of personal injury or death associated with such unintended or unauthorized use, even if such claim alleges that Motorola was negligent regarding the design or manufacture of the part. Motorola and  are registered trademarks of Motorola, Inc. Motorola, Inc. is an Equal Opportunity/Affirmative Action Employer.

How to reach us:

USA/EUROPE/Locations Not Listed: Motorola Literature Distribution;
P.O. Box 5405; Denver, Colorado 80217. 303-675-2140 or 1-800-441-2447

Mfax™: RMFAX0@email.sps.mot.com – TOUCHTONE 602-244-6609
INTERNET: <http://www.mot.com/sps/>

JAPAN: Nippon Motorola Ltd.; Tatsumi-SPD-JLDC, 6F Seibu-Butsuryu-Center,
3-14-2 Tatsumi Koto-Ku, Tokyo 135, Japan. 81-3-3521-8315

ASIA/PACIFIC: Motorola Semiconductors H.K. Ltd.; 8B Tai Ping Industrial Park,
51 Ting Kok Road, Tai Po, N.T., Hong Kong. 852-26629298

