

MOTOROLA SEMICONDUCTOR TECHNICAL DATA

**MC1411,B
MC1412,B
MC1413,B
MC1416,B**

**HIGH VOLTAGE, HIGH CURRENT
DARLINGTON TRANSISTOR ARRAYS**

The seven NPN Darlington connected transistors in these arrays are well suited for driving lamps, relays, or printer hammers in a variety of industrial and consumer applications. Their high breakdown voltage and internal suppression diodes insure freedom from problems associated with inductive loads. Peak inrush currents to 600 mA permit them to drive incandescent lamps.

The MC1411,B device is a general purpose array for use with DTL, TTL, PMOS, or CMOS Logic. The MC1412,B contains a zener diode and resistor in series with the input to limit input current for use with 14 to 25 Volt PMOS Logic. The MC1413,B with a 2.7 kΩ series input resistor is well suited for systems utilizing a 5 Volt TTL or CMOS Logic. The MC1416,B uses a series 10.5 kΩ resistor and is useful in 8 to 18 Volt MOS systems.

**PERIPHERAL
DRIVER ARRAYS
SILICON MONOLITHIC
INTEGRATED CIRCUITS**

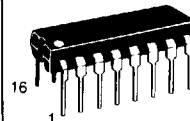

**P SUFFIX
PLASTIC PACKAGE
CASE 648**

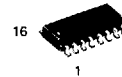

**D SUFFIX
PLASTIC PACKAGE
CASE 751B
(SO-16)**

7

MAXIMUM RATINGS (T_A = 25°C and rating apply to any one device in the package unless otherwise noted)

Rating	Symbol	Value	Unit
Output Voltage	V _O	50	V
Input Voltage (Except MC1411)	V _I	30	V
Collector Current — Continuous	I _C	500	mA
Base Current — Continuous	I _B	25	mA
Operating Ambient Temperature Range MC1411-16 MC1411B-16B	T _A	-20 to +85 -40 to +85	°C
Storage Temperature Range	T _{stg}	-55 to +150	°C
Junction Temperature	T _J	150	°C
Thermal Resistance — Junction-to-Ambient Case 648, P Suffix Case 751B, D Suffix	θ _{JA}	67 100	°C/W

ORDERING INFORMATION

Plastic DIP	SOIC	Ambient Temperature Range
MC1411P (ULN2001A) MC1412P (ULN2002A) MC1413P (ULN2003A) MC1416P (ULN2004A)	MC1411D MC1412D MC1413D MC1416D	-20° to +85°C
MC1411BP MC1412BP MC1413BP MC1416BP	MC1411BD MC1412BD MC1413BD MC1416BD	-40° to +85°C

PIN CONNECTIONS

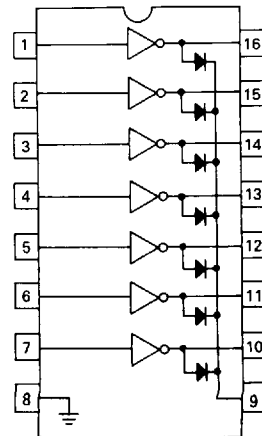

MC1411,B, MC1412,B, MC1413,B, MC1416,B

ELECTRICAL CHARACTERISTICS (T_A = 25°C unless otherwise noted)

Characteristic	Symbol	Min	Typ	Max	Unit
Output Leakage Current (V _O = 50 V, T _A = +85°C) (V _O = 50 V, T _A = +25°C) (V _O = 50 V, T _A = +85°C, V _I = 6.0 V) (V _O = 50 V, T _A = +85°C, V _I = 1.0 V)	I _{CEX} All Types All Types MC1412,B MC1416,B	— — — —	— — — —	100 50 500 500	μA
Collector-Emitter Saturation Voltage (I _C = 350 mA, I _B = 500 μA) (I _C = 200 mA, I _B = 350 μA) (I _C = 100 mA, I _B = 250 μA)	V _{CE(sat)} All Types All Types All Types	— — —	1.1 0.95 0.85	1.6 1.3 1.1	V
Input Current — On Condition (V _I = 17 V) (V _I = 3.85 V) (V _I = 5.0 V) (V _I = 12 V)	I _{I(on)} MC1412,B MC1413,B MC1416,B MC1416,B	— — — —	0.85 0.93 0.35 1.0	1.3 1.35 0.5 1.45	mA
Input Voltage — On Condition (V _{CE} = 2.0 V, I _C = 300 mA) (V _{CE} = 2.0 V, I _C = 200 mA) (V _{CE} = 2.0 V, I _C = 250 mA) (V _{CE} = 2.0 V, I _C = 300 mA) (V _{CE} = 2.0 V, I _C = 125 mA) (V _{CE} = 2.0 V, I _C = 200 mA) (V _{CE} = 2.0 V, I _C = 275 mA) (V _{CE} = 2.0 V, I _C = 350 mA)	V _{I(on)} MC1412,B MC1413,B MC1413,B MC1413,B MC1416,B MC1416,B MC1416,B MC1416,B	— — — — — — — —	— — — — — — — —	13 2.4 2.7 3.0 5.0 6.0 7.0 8.0	V
Input Current — Off Condition (I _C = 500 μA, T _A = +85°C)	I _{I(off)} All Types	50	100	—	μA
DC Current Gain (V _{CE} = 2.0 V, I _C = 350 mA)	h _{FE} MC1411,B	1000	—	—	—
Input Capacitance	C _i	—	15	30	pF
Turn-On Delay Time (50% E _I to 50% E _O)	t _{on}	—	0.25	1.0	μs
Turn-Off Delay Time (50% E _I to 50% E _O)	t _{off}	—	0.25	1.0	μs
Clamp Diode Leakage Current (V _R = 50 V)	I _R T _A = +25°C T _A = +85°C	— —	— —	50 100	μA
Clamp Diode Forward Voltage (I _F = 350 mA)	V _F	—	1.5	2.0	V

TYPICAL PERFORMANCE CURVES — T_A = 25°C

FIGURE 1 — OUTPUT CURRENT versus INPUT VOLTAGE

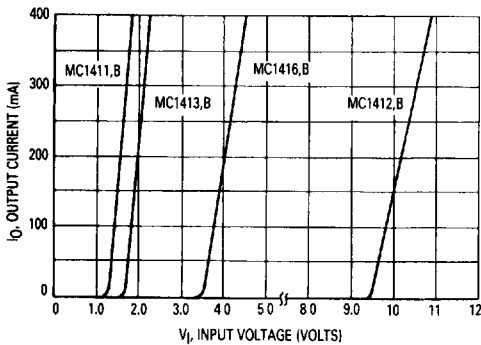
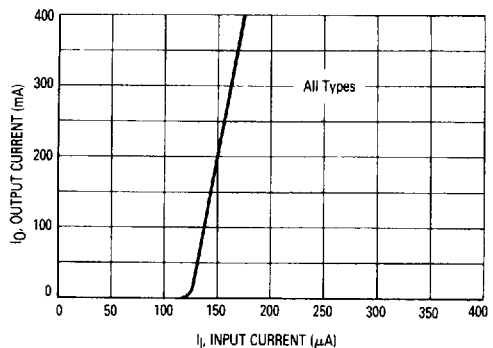

FIGURE 2 — OUTPUT CURRENT versus INPUT CURRENT



MC1411,B, MC1412,B, MC1413,B, MC1416,B

TYPICAL CHARACTERISTIC CURVES - $T_A = 25^\circ\text{C}$ (continued)

FIGURE 3 — TYPICAL OUTPUT CHARACTERISTICS

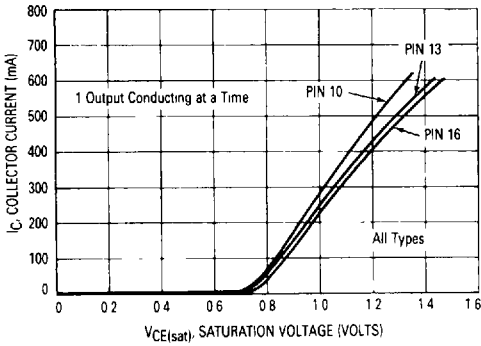

FIGURE 4 — INPUT CHARACTERISTICS — MC1412,B

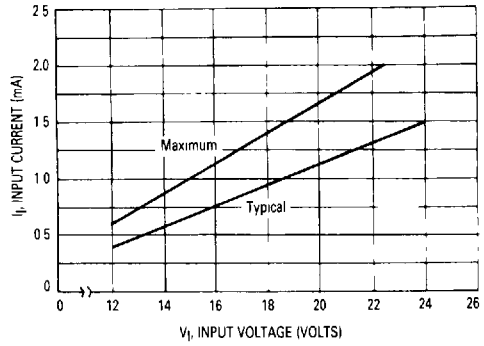

FIGURE 5 — INPUT CHARACTERISTICS — MC1413,B

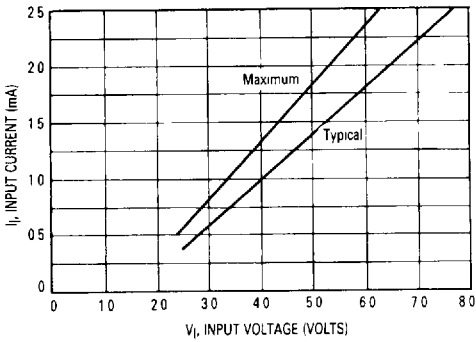

FIGURE 6 — INPUT CHARACTERISTICS — MC1416,B

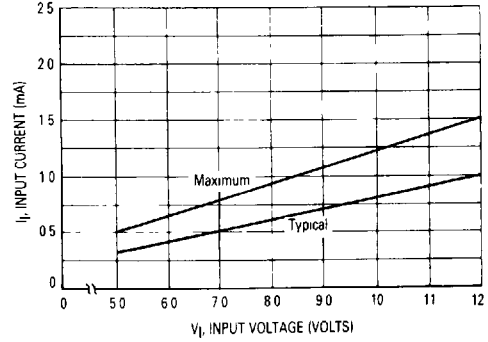
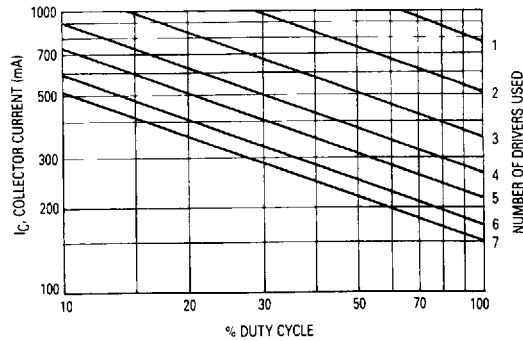
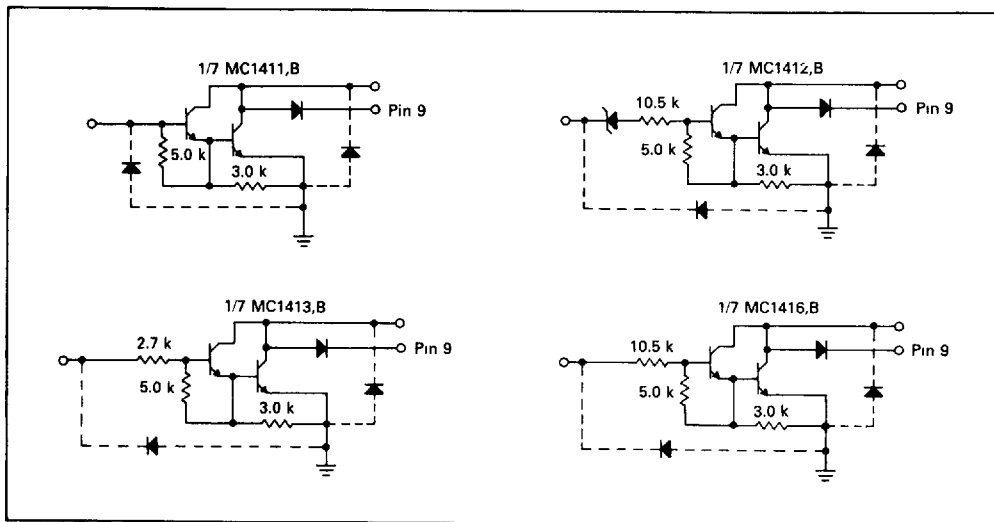

FIGURE 7 — MAXIMUM COLLECTOR CURRENT versus DUTY CYCLE (AND NUMBER OF DRIVERS IN USE)



MC1411,B, MC1412,B, MC1413,B, MC1416,B

FIGURE 8 — REPRESENTATIVE CIRCUIT SCHEMATICS



7