

MC141540

Monitor On-Screen Display CMOS

The MC141540 is a high performance HCMOS device designed to interface with a microcontroller unit to allow colored symbols or characters to be displayed on a color monitor. The on-chip PLL allows both multi-system operation and self-generation of system timing. It also minimizes the MCU's burden through its built-in 273 bytes display/control RAM. By storing a full screen of data and control information, this device has a capability to carry out 'screen-refresh' without MCU supervision.

Since there is no spacing between characters, special graphics-oriented characters can be generated by combining two or more character blocks. Special functions such as character bordering or shadowing, multi-level windows, double height and double width, and programmable vertical length of character can also be incorporated. Furthermore, neither massive information update nor extremely high data transmission rate are expected for normal on-screen display operation, and serial protocols are implemented in lieu of any parallel formats to achieve minimum pin count.

- Fixed Resolution: 320 (CGA) Dots per Line
- Fully Programmable Character Array of 10 Rows by 24 Columns
- 273 Bytes Direct Mapping Display RAM Architecture
- Internal PLL Generates a Wide-Ranged System Clock
- For High-End Monitor Application, Maximum Horizontal Frequency is 100 kHz (32 MHz Dot Clock)
- Programmable Vertical Height of Character to Meet Multi-Sync Requirement
- Programmable Vertical and Horizontal Positioning for Display Center
- 128 Characters and Graphic Symbols ROM
- 10 x 16 Dot Matrix Character
- Character-by-Character Color Selection
- A Maximum of Four Selectable Colors per Row
- Double Character Height and Double Character Width
- Character Bordering or Shadowing
- Three Fully Programmable Background Windows with Overlapping Capability
- Single Positive 5 V Supply
- MC141540P4 is a Replacement for XC141540P with Two Symbols Added in ROM Addresses '5C' and '5E'

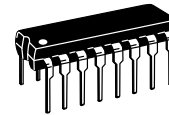

P SUFFIX
PLASTIC DIP
CASE 648

ORDERING INFORMATION

MC141540P4 Plastic DIP

PIN ASSIGNMENT

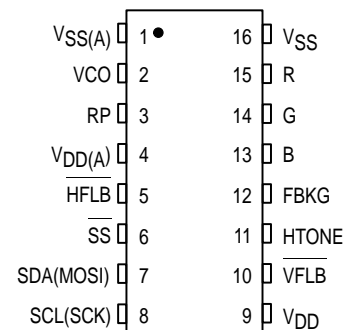

BLOCK DIAGRAM

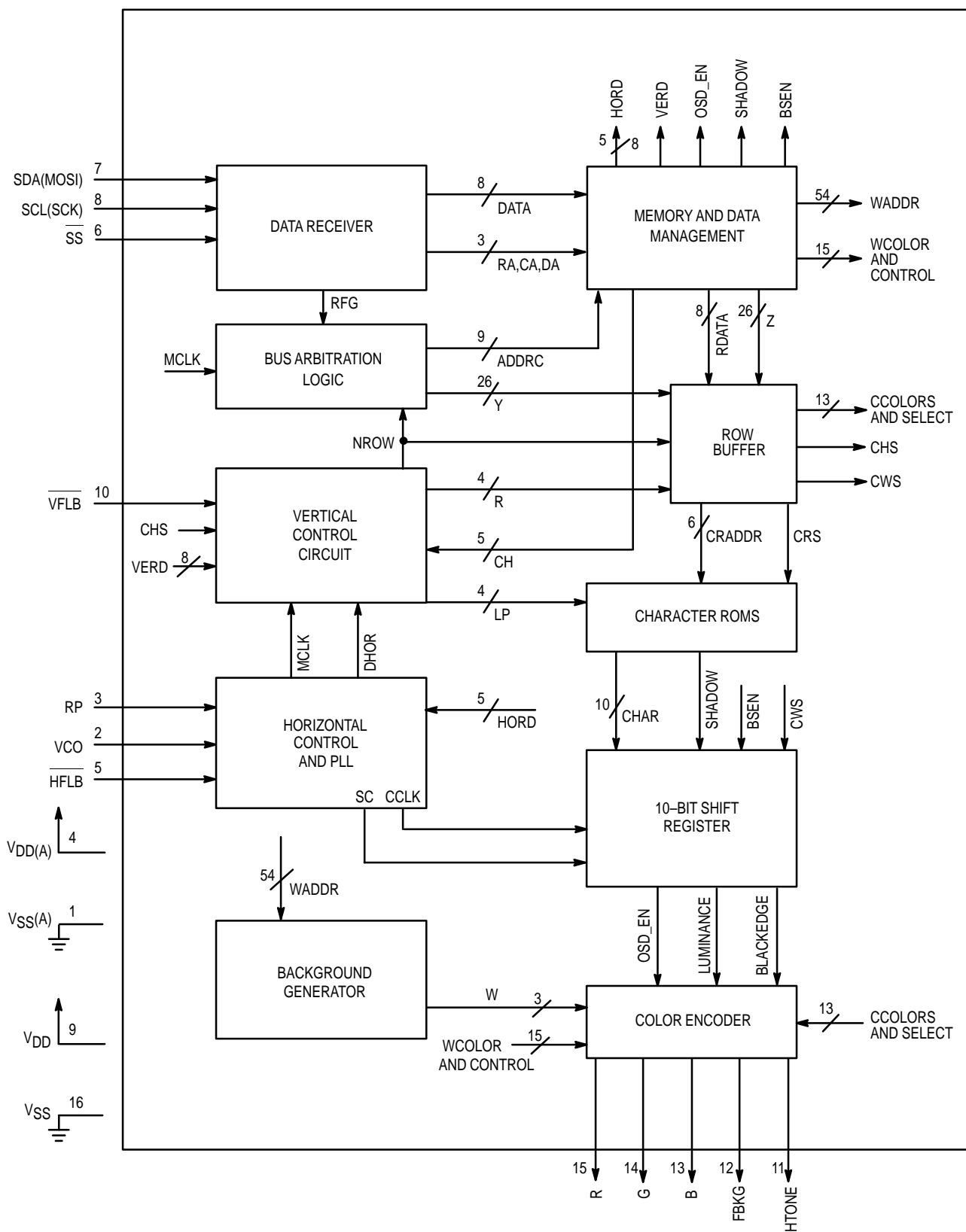

ABSOLUTE MAXIMUM RATINGS Voltage Referenced to V_{SS}

Symbol	Characteristic	Value	Unit
V _{DD}	Supply Voltage	- 0.3 to + 7.0	V
V _{in}	Input Voltage	V _{SS} - 0.3 to V _{DD} + 0.3	V
I _d	Current Drain per Pin Excluding V _{DD} and V _{SS}	25	mA
T _a	Operating Temperature Range	0 to 85	°C
T _{stg}	Storage Temperature Range	- 65 to + 150	°C

NOTE: Maximum Ratings are those values beyond which damage to the device may occur. Functional operation should be restricted to the limits in the Electrical Characteristics tables or Pin Description section.

This device contains circuitry to protect the inputs against damage due to high static voltages or electric fields; however, it is advised that normal precautions be taken to avoid applications of any voltage higher than the maximum rated voltages to this high impedance circuit.

For proper operation it is recommended that V_{in} and V_{out} be constrained to the range V_{SS} ≤ (V_{in} or V_{out}) ≤ V_{DD}. Unused inputs must always be tied to an appropriate logic voltage level (e.g., either V_{SS} or V_{DD}). Unused outputs must be left open.

AC ELECTRICAL CHARACTERISTICS (V_{DD} = V_{DD(A)} = 5.0 V, V_{SS} = V_{SS(A)} = 0 V, T_A = 25°C, Voltage Referenced to V_{SS})

Symbol	Characteristic	Min	Typ	Max	Unit
t _r	Output Signal (R, G, B, FBKG and HTONE) C _{load} = 30 pF, see Figure 1	—	—	10	ns
t _f	Rise Time	—	—	10	ns
F _{HFLB}	HFLB Input Frequency	—	—	100	kHz

DC CHARACTERISTICS V_{DD} = V_{DD(A)} = 5.0 V ± 10%, V_{SS} = V_{SS(A)} = 0 V, T_A = 25°C, Voltage Referenced to V_{SS}

Symbol	Characteristic	Min	Typ	Max	Unit
V _{OH}	High Level Output Voltage I _{out} = - 5 mA	V _{DD} - 0.8	—	—	V
V _{OL}	Low Level Output Voltage I _{out} = 5 mA	—	—	V _{SS} + 0.4	V
V _{IL}	Digital Input Voltage (Not Including SDA and SCL) Logic Low	—	—	0.3 V _{DD}	V
V _{IH}	Logic High	0.7 V _{DD}	—	—	V
V _{IL}	Input Voltage of Pin SDA and SCL in SPI Mode Logic Low	—	—	0.3 V _{DD}	V
V _{IH}	Logic High	0.7 V _{DD}	—	—	V
I _{II}	High-Z Leakage Current (R, G, B and FBKG)	- 10	—	+ 10	μA
I _I	Input Current (Not Including RP, VCO, R, G, B, FBKG and HTONE)	- 10	—	+ 10	μA
I _{DD}	Supply Current (No Load on Any Output)	—	9*	—	mA

* Not a guaranteed limit.

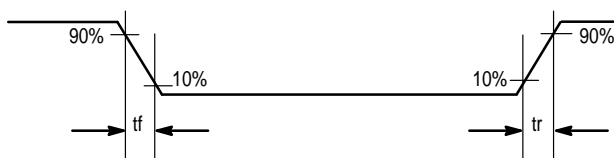

Figure 1. Switching Characteristics

PIN DESCRIPTIONS

VSS(A) (Pin 1)

This pin provides the signal ground to the PLL circuitry. Analog ground for PLL operation is separated from digital ground for optimal performance.

VCO (Pin 2)

Pin 2 is a control voltage input to regulate an internal oscillator frequency. See the Application Diagram for the application values used.

RP (Pin 3)

An external RC network is used to bias an internal VCO to resonate at the specific dot frequency. The value of the resistor for this pin should be adjusted in order to set the pin voltage to around half V_{DD} . See the Application Diagram for the application values used.

VDD(A) (Pin 4)

Pin 4 is a positive 5 V supply for PLL circuitry. Analog power for PLL is separated from digital power for optimal performance.

HFLB (Pin 5)

This pin inputs a negative polarity horizontal synchronize signal pulse to phase lock an internal system clock generated by the on-chip VCO circuit.

SS (Pin 6)

This input pin is part of the SPI serial interface. An active low signal generated by the master device enables this slave device to accept data. This pin should be pulled high to terminate the SPI communication.

SDA (MOSI) (Pin 7)

Data and control messages are being transmitted to this chip from a host MCU via this wire, which is configured as a uni-directional data line. (Detailed description of these two protocols will be discussed in the SPI section).

SCL (SCK) (Pin 8)

A separate synchronizing clock input from the transmitter is required for either protocol. Data is read at the rising edge of each clock signal.

VDD (Pin 9)

This is the power pin for the digital logic of the chip.

VFLB (Pin 10)

Similar to Pin 5, this pin inputs a negative polarity vertical synchronize signal pulse.

HTONE (Pin 11)

This pin outputs a logic high during windowing except when graphics or characters are being displayed. It is used to lower the external R, G, and B amplifiers' gain to achieve a transparent windowing effect.

FBKG (Pin 12)

This pin outputs a logic high while displaying characters or windows when the FBKGC bit in the frame control register is 0, and output a logic high only while displaying characters when the FBKGC bit is 1. It is defaulted to high-impedance state after power-on, or when there is no output. An external 10 k Ω resistor pulled low is recommended to avoid level toggling caused by hand effect when there is no output.

B,G,R (Pins 13,14,15)

MOSD color output is TTL level RGB to the host monitor. These three signals are active high output pins that are in a high-impedance state when MOSD is disabled.

VSS (Pin 16)

This is the ground pin for the digital logic of the chip.

SYSTEM DESCRIPTION

MC141540 is a full-screen memory architecture. Refresh is performed by the built-in circuitry after a screenful of display data has been loaded through the serial bus. Only changes to the display data need to be input afterward.

Serial data, which includes screen mapping address, display information, and control messages, are transmitted via the SPI bus. Figure 2 contains the SPI protocol operating procedure.

Data is received from the serial port and stored by the memory management circuit. Line data is stored in a row buffer for display and refreshing. During this storing and retrieving cycle, bus arbitration logic patrols the internal traffic to make sure that no crashes occur between the slower serial bus receiver and the fast 'screen-refresh' circuitry. After the full-screen display data is received through one of the serial communication interfaces, the link can be terminated if a change of the display is not required.

The bottom half of the block diagram contains the hardware functions for the entire system. It performs all the MOSD functions such as programmable vertical length (from 16 lines to 63 lines), display clock generation (which is phase locked to the incoming horizontal sync signal at Pin 5 HFLB), bordering or shadowing, and multiple windowing.

COMMUNICATION PROTOCOLS

Serial Peripheral Interface (SPI)

SPI is a three-wire serial communication link that requires separate clock (SCK) and data (MOSI) lines. In addition, an SS slave select pin is controlled by the master transmitter to initiate the receiver.

Operating Procedure

To initiate SPI transmission, the SS pin is pulled low by the master device to enable MC141540 to accept data. The SS input line must be a logic low prior to the occurrence of SCK, and remain low until and after the last (eighth) SCK cycle. After all data has been sent, the SS pin is then pulled high by the master to terminate the transmission. No slave address is needed for SPI. Hence, row and column address information and display data can be sent immediately after the SPI is initiated.

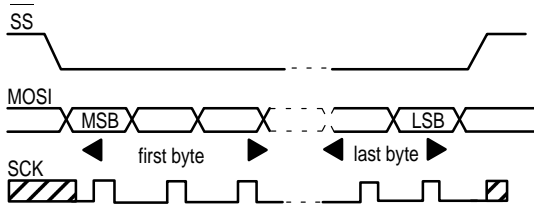

Figure 2. SPI Protocol

DATA TRANSMISSION FORMATS

After the proper identification by the receiving device, a data train of arbitrary length is transmitted from the master. There are three transmission formats from (a) to (c) as stated below. The data train in each sequence consists of row address (R), column address (C), and display information (I), as shown in Figure 3. In format (a), display information data must be preceded with the corresponding row address and column address. This format is particularly suitable for updating small amounts of data between different rows. However, if the current information byte has the same row address as the one before, format (b) is recommended.

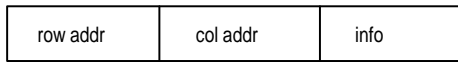

Figure 3. Data Packet

For a full-screen pattern change that requires a massive information update, or during power-up, most of the row and column addresses of either (a) or (b) formats will be consecutive. Therefore, a more efficient data transmission format (c) should be applied. This sends the RAM starting row and column addresses once only, and then treats all subsequent data as display information. The row and column addresses will be automatically incremented internally for each display information data from the starting location. Because Columns 24 through 29 are unused, it is recommended that these locations are filled with dummy data while using format (c) to transmit.

The data transmission formats are:

- (a) R → C → I → R → C → I →
- (b) R → C → I → C → I → C → I
- (c) R → C → I → I → I →

To differentiate the row and column addresses when transferring data from master, the MSB (most significant bit) is set, as in Figure 4: '1' to represent row, and '0' for column address. Furthermore, to distinguish the column address between formats (a), (b), and (c), the sixth bit of the column address is set to '1' which represents format (c), and '0' for format (a) or (b). However, there is some limitation on using mixed formats during a single transmission. It is permissible to change the format from (a) to (b), or from (a) to (c), or from (b) to (a), but not from (c) back to (a) or (b).

ADDRESS	BIT							FORMAT	
	7	6	5	4	3	2	1		0
ROW	1	X	X	X	D	D	D	D	a, b, c
COLUMN	0	0	X	D	D	D	D	D	a, b
COLUMN	0	1	X	D	D	D	D	D	c

X: don't care D: valid data

Figure 4. Row & Column Address Bit Patterns

MEMORY MANAGEMENT

Internal RAM is addressed with row and column (coln) numbers in sequence. The spaces between Row 0 and Coln 0 to Row 9 and Coln 23 are called display registers, and each contains a character ROM address corresponding to a display location on the monitor screen. Every data row is associated with two control registers, which are located at Coln 30 and 31 of their respective rows, to control the character display format of that row. In addition, three window control registers for each of the three windows, together with three frame control registers, occupy the first 13 columns of Row 10.

The user should handle the internal RAM address location with care, especially those rows with double length alphanumeric symbols. For example, if Row n is destined to be double height on the memory map, the data displayed on screen Rows n and n+1 will be represented by the data contained in the memory address of Row n only. The data of the next Row n+1 on the memory map will appear on the screen as n+2 and n+3 row space, and so on. Hence, it is not necessary to load a row of blank data to compensate for the double row. The user should minimize excessive rows of data in memory in order to avoid overrunning the limited amount of row space on the screen.

For rows with double width alphanumeric symbols, only the data contained in the even numbered columns of the memory map are shown. Odd numbered columns are treated in the same manner as double height rows.

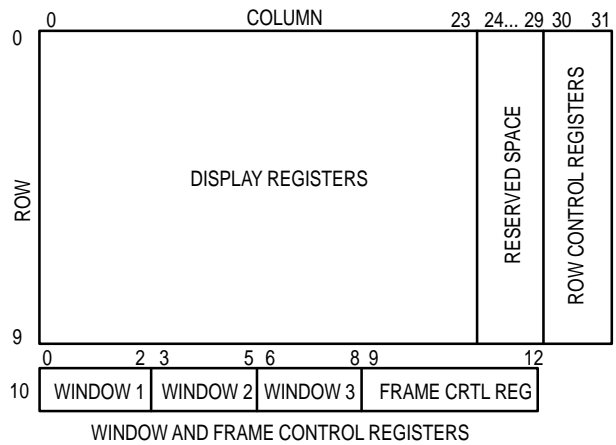
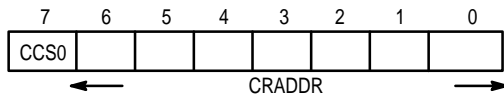

Figure 5. Memory Map

REGISTERS

Display Register



Bit 7 CCS0 — This bit defines a specific character color out of the two preset colors. Color 1 is selected if this bit is cleared, and Color 2 otherwise.

Bit 6–0 CRADDR — These seven bits address the 128 characters or symbols residing in the character ROM.

Row Control Registers

Coln 30

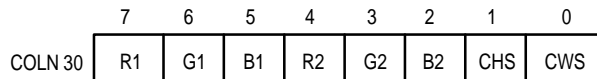

Bits 7–2 — Color 1 is determined by R1, G1, and B1; Color 2 by R2, G2, and B2.

Bit 1 CHS — This bit determines the height of a display symbol. When it is set, the symbol is displayed in double height.

Bit 0 CWS — Bit 0 is similar to Bit 1; when this bit is set, the character is displayed in double width.

Coln 31

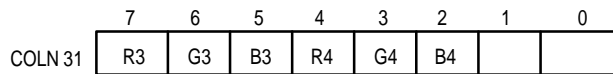

Bits 7–2 — Color 3 is determined by R3, G3, and B3; Color 4 by R4, G4, and B4.

Window 1 Registers

Row 10 Coln 0, 3, or 6

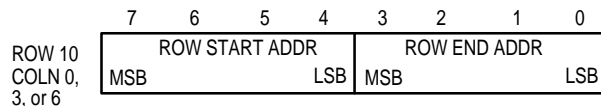

Row 10 Coln 1, 4, or 7

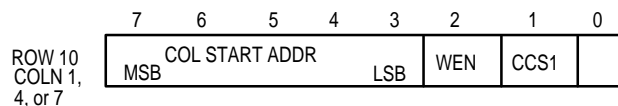

Bit 2 WEN — This bit enables the background Window 1 generation when it is set.

Bit 1 CCS1 — This additional color select bit provides the characters residing within Window 1 with two extra color selections, making a total of four selections for that row.

Row 10 Coln 2, 5, or 8

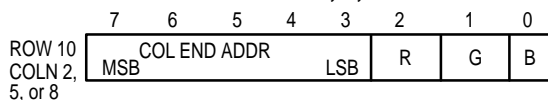

Window 1 occupies Columns 0–2 of Row 10; Window 2 occupies Columns 3–5; and Window 3 occupies Columns 6–8. Window 1 has the highest priority, and Window 3 the least. If window overlapping occurs, the higher priority window will cover the lower one, and the higher priority color will take over on the overlap window area. If the start address is greater than the end address, this window will not be displayed.

Frame Control Registers

Coln 9

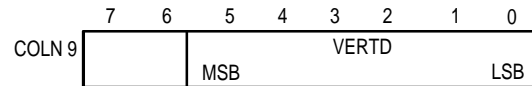

Bit 7–0 VERTD — These six bits define the vertical starting position. There are a total of 64 steps, with an increment of four horizontal lines per step for each field. The value cannot be zero anytime, and the default value is 4.

Coln 10

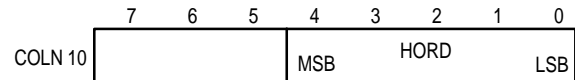

Bit 6–0 HORD — These bits define the horizontal starting position for character display. Five bits give a total of 32 steps and each increment represents a five-dot shift to the right on the monitor screen. The value cannot be zero anytime, and the default value is 5.

Coln 11

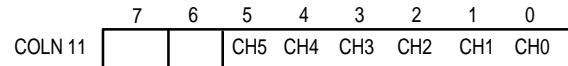

Bit 5–0 CH5–CH0 — These six bits determine the displayed character height. It is possible to have a proper character height by setting a value greater than or equal to 16 on a different horizontal frequency monitor. Setting a value below 16 will not have a predictable result. Figure 6 illustrates how this chip expands the built-in character font to the desired height.

Coln 12

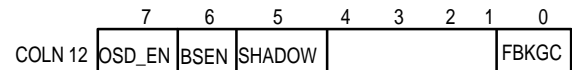

Bit 7 OSD_EN — The OSD circuit is activated when this bit is set.

Bit 6 BSEN — This bit enables the character bordering or shadowing function when it is set.

Bit 5 SHADOW — Characters with black-edge shadowing are selected if this bit is set; otherwise bordering prevails.

Bit 0 FBKGC — Bit 0 determines the configuration of the FBKG output pin. When it is clear, the FBKG pin outputs high while displaying characters or windows; otherwise, the FBKG pin outputs high only while displaying characters.

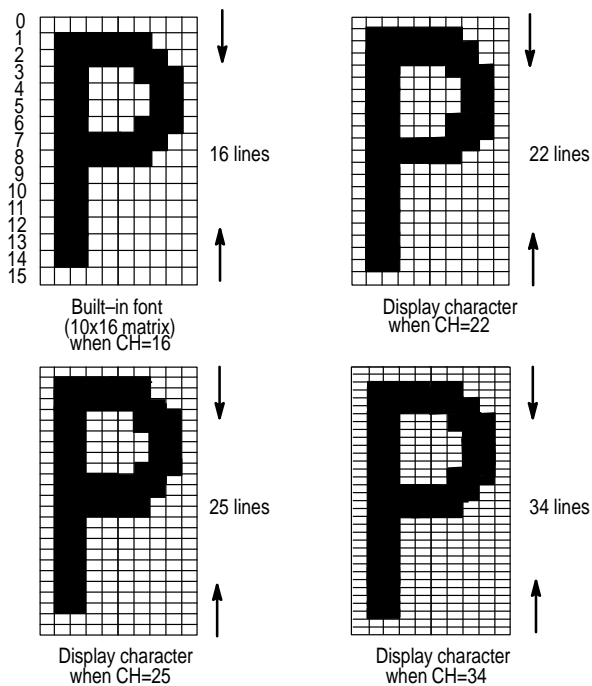

Figure 6. Variable Character Height

An IBM PC program called “MOSD Font Editor” (Rev. 2.0) was written for MC141540 editing purposes. This program generates a set of S-Record or Binary record for the desired display patterns to be masked onto the character ROM of the MC141540.

In order to have better character display within windows, it is suggested that the designed character font be placed in the center of the 10 x 16 matrix with equal space on all four sides. The character \$00 is predefined for blank characters, and the character \$7F is predefined for full-filled characters.

In order to avoid submersion of displayed symbols or characters into a background of comparable colors, a feature of bordering which encircles all four sides, or shadowing which encircles only the right and bottom sides of an individual display character, are provided. Figure 7 shows how a character is jacketed differently. To make sure that a character is bordered or shadowed correctly, at least one blank dot should be reserved on each side of the character font.

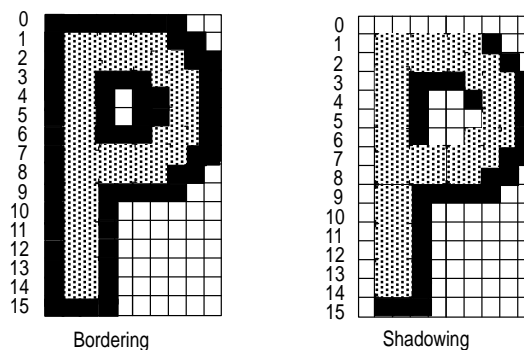

Figure 7. Character Bordering and Shadowing

Frame Format and Timing

Figure 8 illustrates the positions of all display characters on the screen relative to the leading edge of horizontal and vertical flyback signals. The shaded area indicates the area outside the “safe viewing area” for the display characters. Notice that there are two components in the equations stated in Figure 8 for horizontal and vertical delays: fixed delays from the leading edge of HFLB and VFLB signals, regardless of the values of HORD and VERTD (47 dots + phase detection pulse width) and one H scan line for horizontal and vertical delays, respectively; and variable delays determined by the values of HORD and VERTD. Refer to **Frame Control Registers Coln 9 and 10** for the definitions of VERTD and HORD.

Phase detection pulse width is a function of the external charge-up resistor, which is the 330 kΩ resistor in a series with 2 kΩ to VCO pin in the Application Diagram. Dot frequency is determined by the equation $H \text{ freq} \times 320$. For example, dot frequency is 10.24 MHz if H freq is 32 kHz. Hence, a dot equals 1/10.24 μs.

When double character width is selected for a row, only the even-numbered characters will be displayed, as shown in Row 2. Notice that the total number of horizontal scan lines in the display frame is variable, depending on the chosen character height of each row. Care should be taken while configuring each row character height so that the last horizontal scan line in the display frame always comes out before the leading edge of VFLB of the next frame, to avoid wrapping display characters of the last few rows in the current frame into the next frame. The number of display dots in a horizontal scan line is always fixed at 240, regardless of row character width.

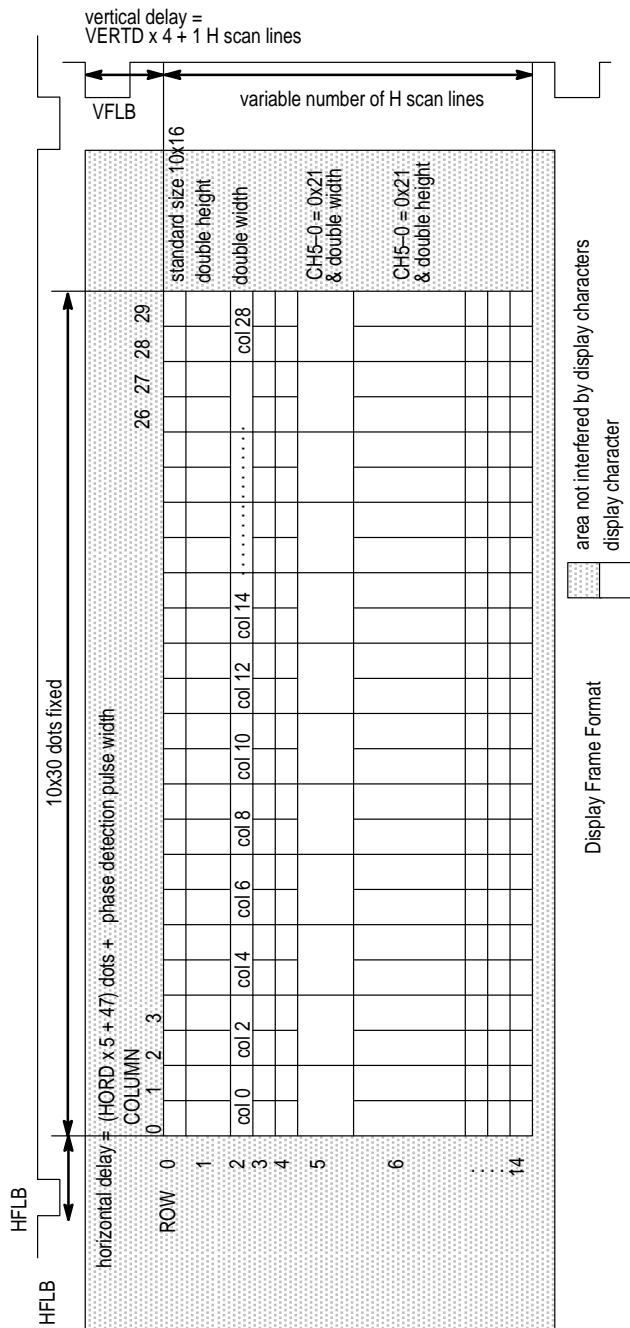

Figure 8. Display Frame Format

Figure 9 illustrates the timing of all output signals as a function of window and fast-blanking features. Line 3 of all three characters is used to illustrate the timing signals. The shaded area depicts the window area. The characters on the left and right appear identical except for the FBKGC bit. The middle character does not have a window as its background.

Notice that signal HTONE is active only in the window area. Timing of the signal FBKG depends on the configuration of the FBKGC bit. The configuration of the FBKGC bit affects only the FBKG signal timing; it has no effect on the timing of HTONE. Waveform 'R, G, or B', which is the actual waveform at R, G, or B pin, is the logical OR of waveform 'character R, G, or B' and waveform 'window R, G, or B'. 'Character R, G, or B' and 'window R, G, or B' are internal signals for illustration purpose only. Also notice that HTONE has exactly the same waveform as 'window R, G, or B'.

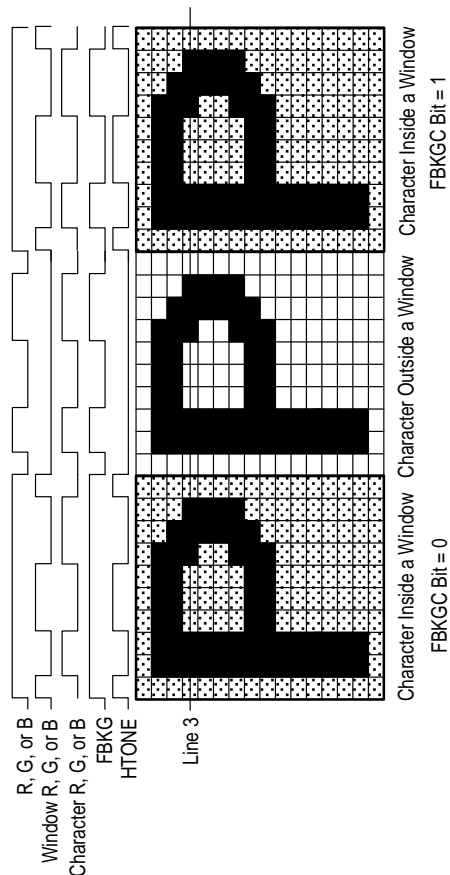

Figure 9. Timing of Output Signals as a Function of Window and FBKGC Bit Features

FONT

Icon Combination

MC141540 contains 128-character ROM. The user can create an on-screen menu based on those characters and icons. Addresses \$00 and \$7F are predefined characters. They cannot be modified in any MOSDs.

ROM CONTENT

Figures 10 – 13 show the ROM content of MC141540. Mask ROM is optional for custom parts.

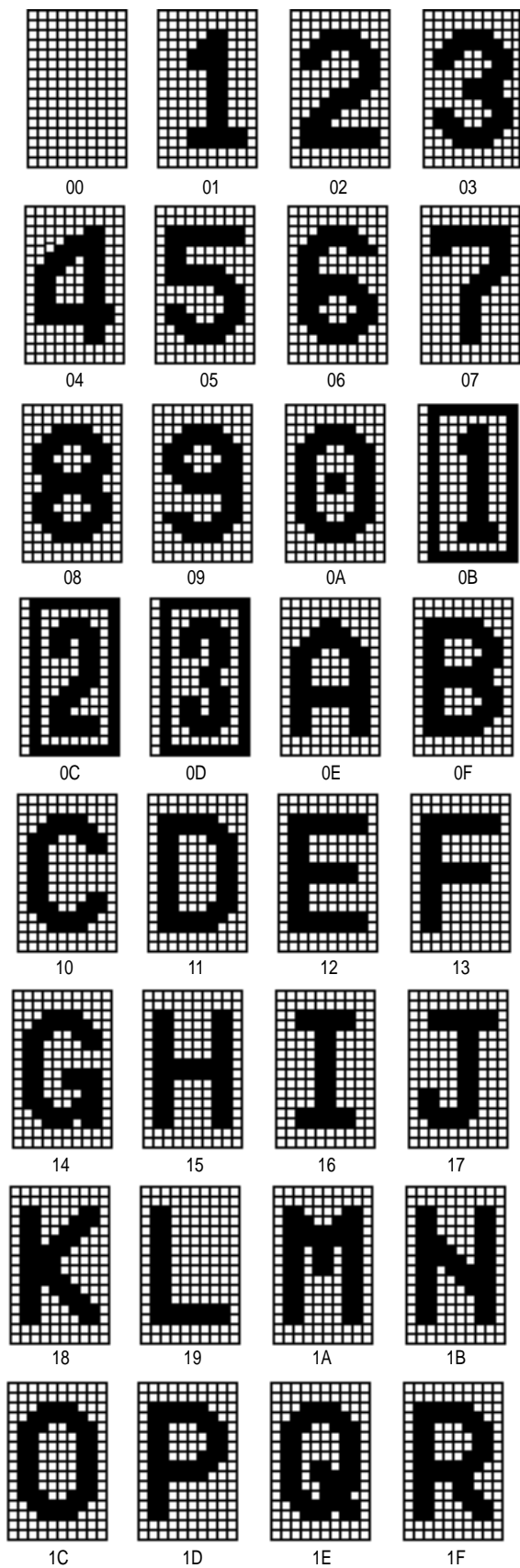

Figure 10. ROM Address (\$00 – \$1F)

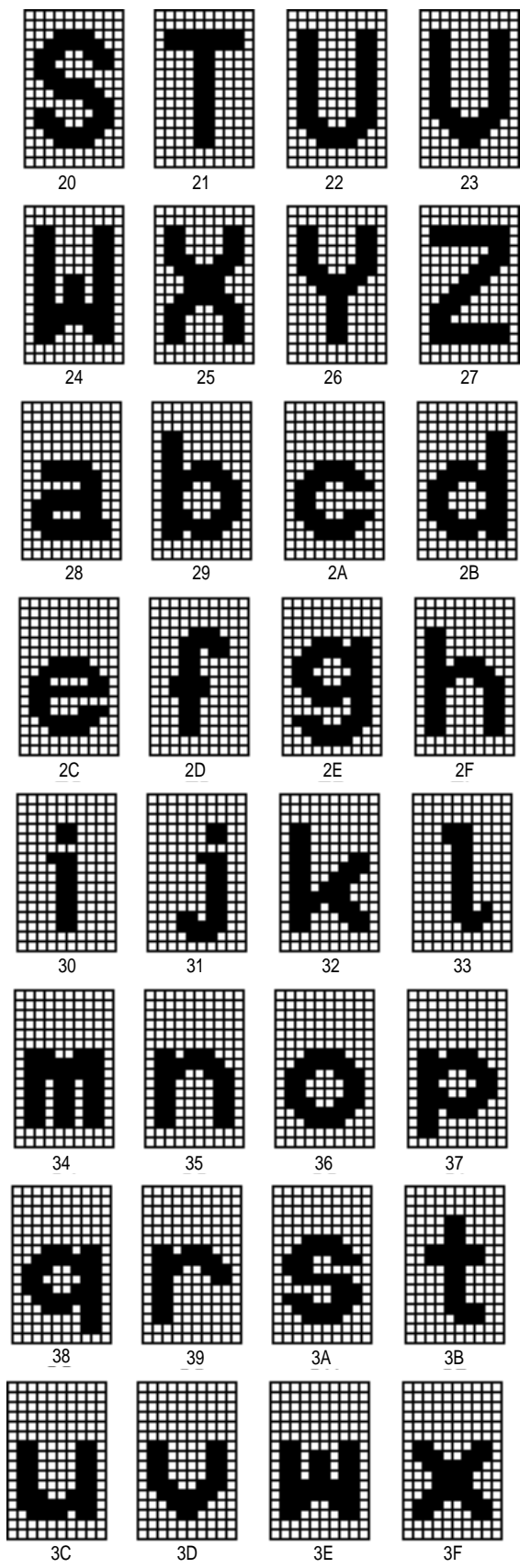

Figure 11. ROM Address (\$20 – \$3F)

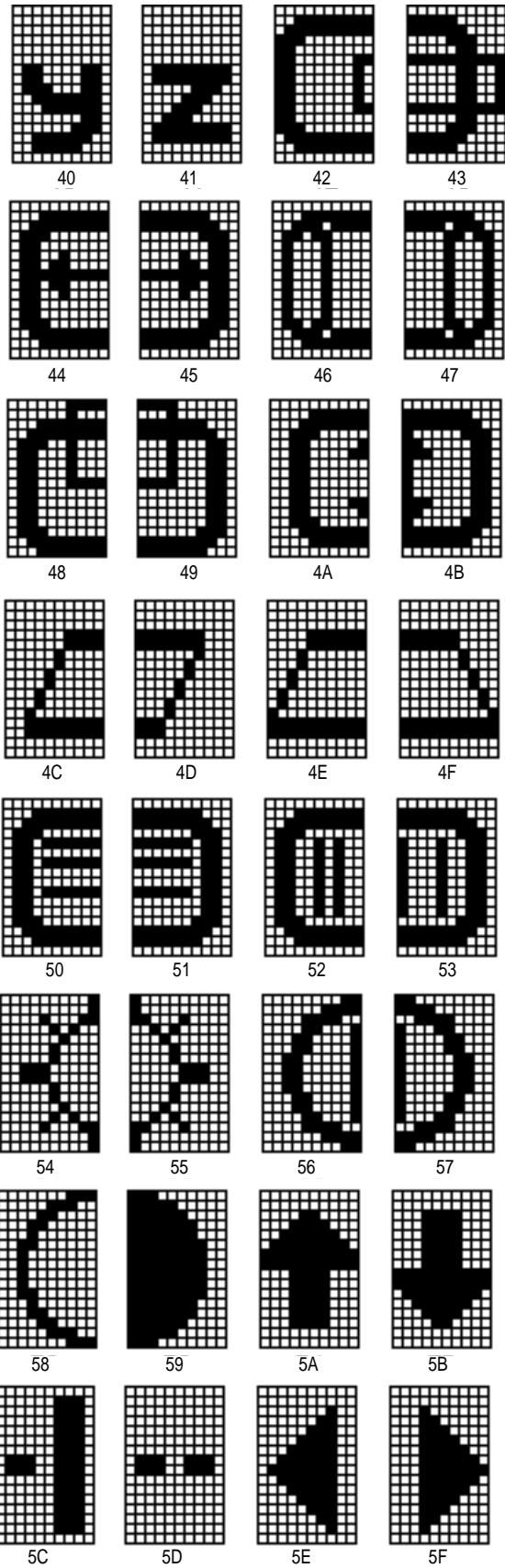

Figure 12. ROM Address (\$40 – \$5F)

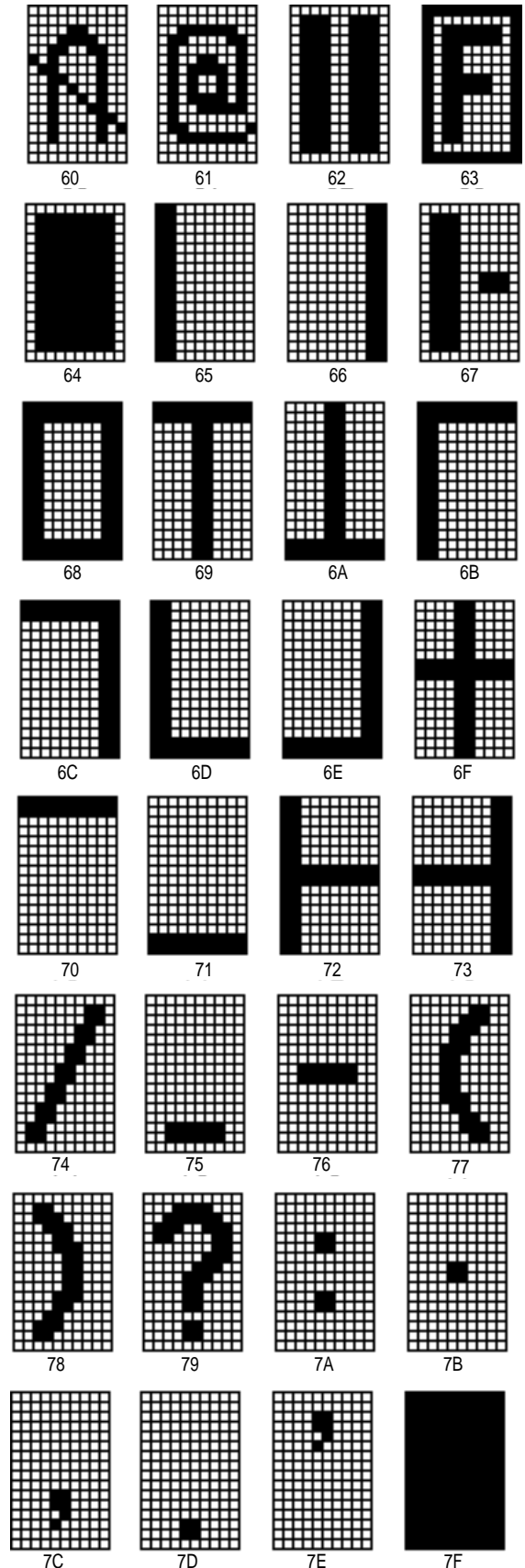

Figure 13. ROM Address (\$60 – \$7F)

DESIGN CONSIDERATIONS

Distortion

Motorola's MC141540 has a built-in PLL for multi-system application. Pin 2 voltage is dc-biased for the internal VCO in the PLL. When the input frequency (HFLB) to Pin 5 increases, the VCO frequency will increase accordingly. This forces the PLL to a higher locked frequency output. The frequency should be equal to $320 \times \text{HFLB}$. This is the pixel dot clock.

Display distortion is caused by noise on Pin 2. Positive noise increases the VCO frequency above normal. The corresponding scan line will be shorter accordingly. In contrast, negative noise causes the scan line to be longer. The net result will be distortion on the display, especially on the right hand side of the display window.

In order to have distortion-free display, the following recommendations should be considered:

- Only analog part grounds (Pin 2 to Pin 4) can be connected to Pin 1 ($V_{SS(A)}$). V_{SS} and other grounds should be connected to PCB common ground. The $V_{SS(A)}$ and V_{SS} grounds should be totally separated (i.e. $V_{SS(A)}$ is floating). Refer to the Application Diagram for the ground connections.

- The dc supply path for Pin 9 (V_{DD}) should be separated from other switching devices.
- The LC filter should be connected between Pin 9 and Pin 4. Refer to the values used in the Application Diagram.
- Biasing and filter networks should be connected to Pin 2 and Pin 3. Refer to the recommended networks in the Application Diagram.
- Two small capacitors can be connected between Pins 2 and 3, and between Pins 3 and 4.

Jittering

Most display jittering is caused by HFLB jittering on Pin 5. Care must be taken if the HFLB signal comes from the fly-back transformer. A short path and shielded cable are recommended for a clean signal. A small capacitor can be added between Pin 5 and Pin 16 to smooth the signal. Refer to the value used in the Application Diagram.

Display Dancing

Most display dancing is caused by interference of the serial bus. It can be avoided by adding series resistors to the serial bus.

APPLICATION DIAGRAM

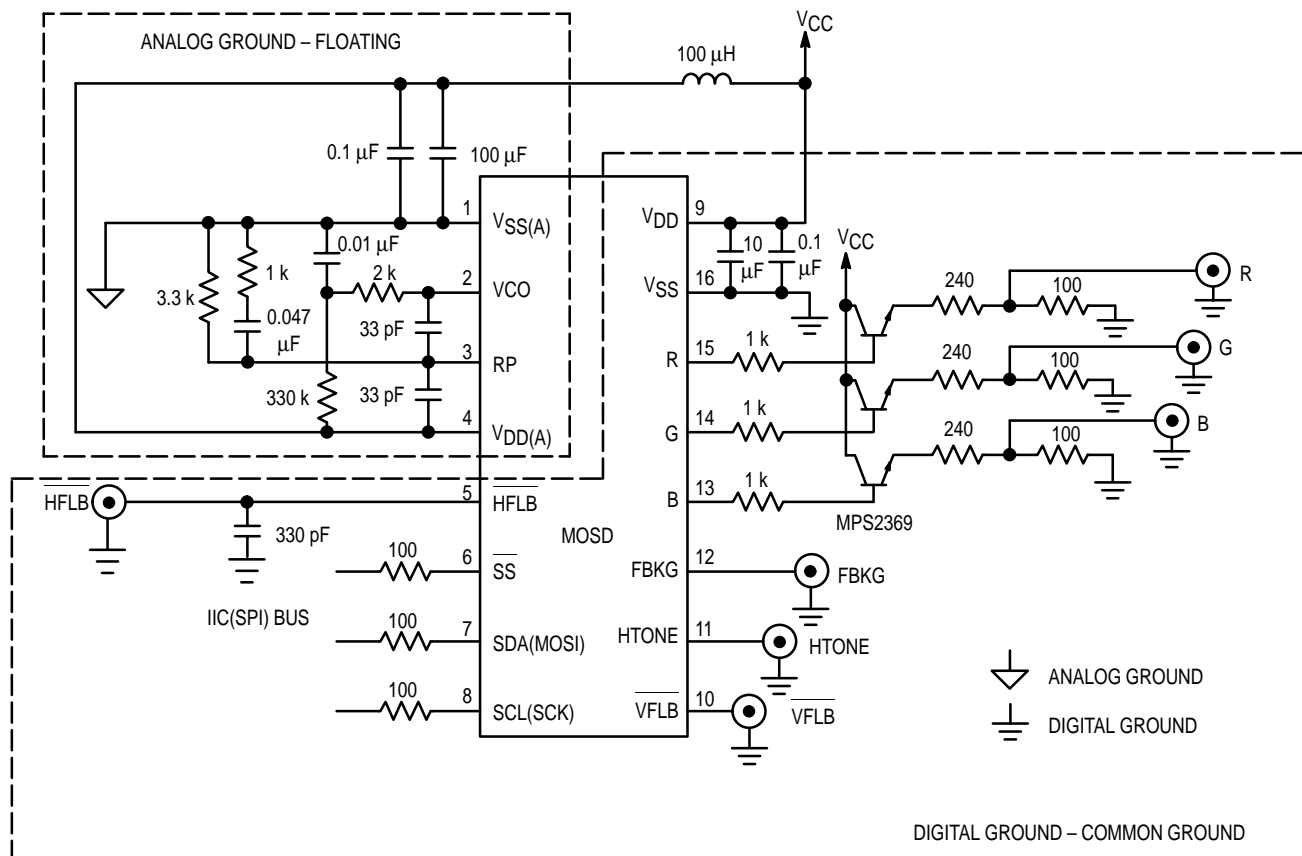

PACKAGE DIMENSIONS

P SUFFIX PLASTIC DIP CASE 648-08

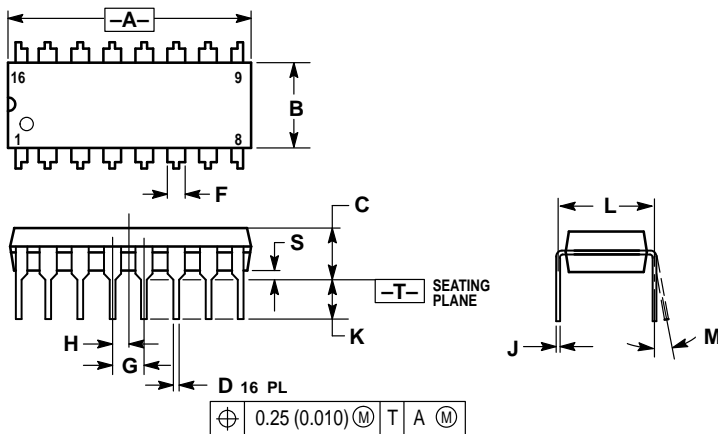

NOTES:

1. DIMENSIONING AND TOLERANCING PER ANSI Y14.5M, 1982.
2. CONTROLLING DIMENSION: INCH.
3. DIMENSION L TO CENTER OF LEADS WHEN FORMED PARALLEL.
4. DIMENSION B DOES NOT INCLUDE MOLD FLASH.
5. ROUNDED CORNERS OPTIONAL.

DIM	INCHES		MILLIMETERS	
	MIN	MAX	MIN	MAX
A	0.740	0.770	18.80	19.55
B	0.250	0.270	6.35	6.85
C	0.145	0.175	3.69	4.44
D	0.015	0.021	0.39	0.53
F	0.040	0.70	1.02	1.77
G	0.100 BSC		2.54 BSC	
H	0.050 BSC		1.27 BSC	
J	0.008	0.015	0.21	0.38
K	0.110	0.130	2.80	3.30
L	0.295	0.305	7.50	7.74
M	0°	10°	0°	10°
S	0.020	0.040	0.51	1.01

Motorola reserves the right to make changes without further notice to any products herein. Motorola makes no warranty, representation or guarantee regarding the suitability of its products for any particular purpose, nor does Motorola assume any liability arising out of the application or use of any product or circuit, and specifically disclaims any and all liability, including without limitation consequential or incidental damages. "Typical" parameters which may be provided in Motorola data sheets and/or specifications can and do vary in different applications and actual performance may vary over time. All operating parameters, including "Typicals" must be validated for each customer application by customer's technical experts. Motorola does not convey any license under its patent rights nor the rights of others. Motorola products are not designed, intended, or authorized for use as components in systems intended for surgical implant into the body, or other applications intended to support or sustain life, or for any other application in which the failure of the Motorola product could create a situation where personal injury or death may occur. Should Buyer purchase or use Motorola products for any such unintended or unauthorized application, Buyer shall indemnify and hold Motorola and its officers, employees, subsidiaries, affiliates, and distributors harmless against all claims, costs, damages, and expenses, and reasonable attorney fees arising out of, directly or indirectly, any claim of personal injury or death associated with such unintended or unauthorized use, even if such claim alleges that Motorola was negligent regarding the design or manufacture of the part. Motorola and  are registered trademarks of Motorola, Inc. Motorola, Inc. is an Equal Opportunity/Affirmative Action Employer.

Mfax is a trademark of Motorola, Inc.

How to reach us:

USA/EUROPE/Locations Not Listed: Motorola Literature Distribution;
P.O. Box 5405, Denver, Colorado 80217. 303-675-2140 or 1-800-441-2447

JAPAN: Nippon Motorola Ltd.; Tatsumi-SPD-JLDC, 6F Seibu-Butsuryu-Center,
3-14-2 Tatsumi Koto-Ku, Tokyo 135, Japan. 81-3-3521-8315

Mfax™: RMFAX0@email.sps.mot.com – TOUCHTONE 602-244-6609
– US & Canada ONLY 1-800-774-1848

ASIA/PACIFIC: Motorola Semiconductors H.K. Ltd.; 8B Tai Ping Industrial Park,
51 Ting Kok Road, Tai Po, N.T., Hong Kong. 852-26629298

INTERNET: <http://www.mot.com/SPS/>



MC141540/D