

ORDERING INFORMATION

Device	Temperature Range	Package
MC1438R	0°C to +70°C	Metal Power
MC1538R	-55°C to +125°C	Metal Power

MC1438R MC1538R

POWER BOOSTER

The MC1538/MC1438 is designed as a high current gain amplifier (70 dB), with unity voltage gain that can deliver load currents up to ± 300 mA dc. This device is ideally suited to follow an operational amplifier (such as MC1556/MC1456) for driving low impedance loads and improving the overall circuit performance.

- High Input Impedance – 0.4 Meg-Ohm typ – when driving the MC1538/MC1438, the gain of an operational amplifier will approach the unloaded open-loop gain. Internal power dissipation of the operational amplifier will be independent of output voltage and therefore thermal drift will be reduced.
- Large Power Bandwidth – 1.5 MHz typ – considerably better than present operational amplifiers. Bandwidth and slew rate will be limited by the operational amplifier, not the MC1538/MC1438.
- Low Output Impedance – 10 Ohms typ – allows the MC1538/MC1438 to drive a capacitive load with greatly reduced phase shift compared with an operational amplifier. Output voltage swing capability is much increased when driving small load impedances.
- Adjustable Current Limit – ± 5.0 mA dc to ± 300 mA dc
- Excellent Power-Supply Rejection – 1.0 mV/V typ
- Current Gain – 3000 typ

OPERATIONAL AMPLIFIERS POWER BOOSTER

SILICON MONOLITHIC
INTEGRATED CIRCUIT



R SUFFIX
CASE 614

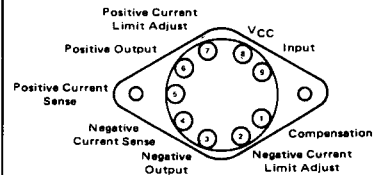

TYPICAL APPLICATIONS

6

OPERATIONAL AMPLIFIER BOOST CIRCUIT

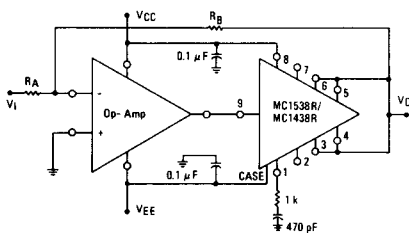

DIGITAL OR ANALOG LINE DRIVER

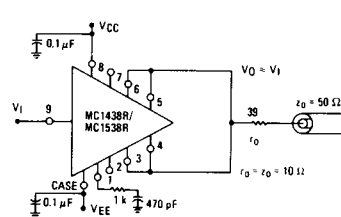

POWER SUPPLY SPLITTER

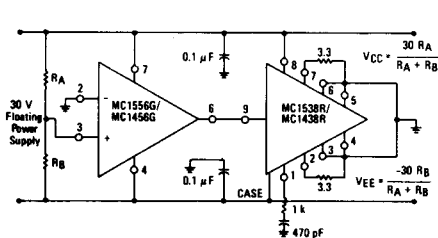

SERVO/POWER AMPLIFIER

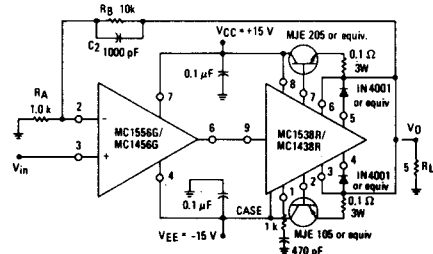

Under some conditions of circuit layout and loading, the MC1538R/MC1438R will oscillate when driven into current limiting. Oscillation during positive current limiting can usually be suppressed by placing a 0.02 μ F capacitor between Pins 7 and 5. Oscillations during negative current limit can usually be suppressed by placing a 0.02 μ F capacitor between Pins 1 and 2. 100 Ohms in series with this capacitor will reduce any cross-over distortion occurring when driving extremely low impedance loads.

MC1438R, MC1538R

MAXIMUM RATINGS (T_C = +25°C unless otherwise noted.)

Rating	Symbol	MC1538R	MC1438R	Unit
Power Supply Voltage	V _{CC} V _{EE}	+22 -22	+18 -18	Vdc
Input Voltage Swing	V _{in}	V _{CC} or V _{EE}		Vdc
Load Current	I _L	350		mAdc
Power Dissipation @ T _A = +25°C Derate above T _A = +25°C	P _D 1/R _{θJA}	3.0 24		Watts mW/°C
Power Dissipation @ T _C = +25°C Derate above T _C = +25°C	P _D 1/R _{θJC}	17.5 140		Watts mW/°C
Operating Ambient Temperature Range MC1438R MC1538R	T _A	0 to +70 -55 to +125		°C
Operating and Storage Junction Temperature Range	T _J , T _{stg}	-65 to +150		°C

THERMAL CHARACTERISTICS

Characteristic	Symbol	Max	Unit
Thermal Resistance, Junction to Ambient	R _{θJA}	41.6	°C/W
Thermal Resistance, Junction to Case	R _{θJC}	7.15	°C/W

ELECTRICAL CHARACTERISTICS

(R_L = 300 ohms, T_C = +25°C unless otherwise noted.)

Characteristic (Linear Operation)	Fig	Note	Symbol	MC1538R			MC1438R			Unit
				5.0 V < V _{CC} = V _{EE} < 20 V			V _{CC} = +15 V, V _{EE} = -15 V			
				Min	Typ	Max	Min	Typ	Max	
Voltage Gain (f = 1.0 kHz)	1	—	A _V	0.9	0.95	1.0	0.85	0.95	1.0	V/V
Current Gain (A _I = ΔI _O /ΔI _I)	1	—	A _I	—	3000	—	—	3000	—	A/A
Output Impedance (f = 1.0 kHz)	1	—	z _o	—	10	—	—	10	—	Ohms
Input Impedance (f = 1.0 kHz)	1	—	z _i	—	400	—	—	400	—	k ohms
Output Voltage Swing (See Note 3)	1	3	V _O	±12	±13	—	±11	±12	—	Vdc
Input Bias Current	2	—	I _{IB}	—	60	200	—	60	300	μAdc
Output Offset Voltage	2	1	V _{OO}	—	25	150	—	25	200	mVdc
Small Signal Bandwidth (R _L = 300 ohms) (V _I = 0 Vdc, V _I = 100 mV[rms])	1	—	BW	—	8.0	—	—	8.0	—	MHz
Power Bandwidth (See Note 3) (V _O = 20 V _{p-p} , THD = 5%)	1	—	BW _p	—	1.5	—	—	1.5	—	MHz
Total Harmonic Distortion (Note 3) (f = 1.0 kHz, V _O = 20 V _{p-p})	1	—	THD	—	0.5	—	—	0.5	—	%
Output Short-Circuit Current (R ₁ = R ₂ = ∞) (R ₁ = R ₂ = 3.3 ohms) Adjustable Range	3 3 4,5	2	I _{OS}	75 — —	95 300 5.0 to 300	125 — —	65 — —	95 300 5.0 to 300	140 — —	mAdc
Power Supply Sensitivity (V _{EE} constant) (V _{CC} constant)	2	—	PSRR	— —	1.0 1.0	— —	— —	1.0 1.0	— —	mV/V
Power Supply Current (R _L ∞, V _I = 0)	2	—	I _{CC} I _{EE}	4.5	6.0	10	2.5	6.0	15	mAdc
Power Dissipation (See Note 3) (R _L ∞, V _I = 0)	2	3	P _C	150	180	300	75	180	450	mW

Note 1. Output offset Voltage is the quiescent dc output voltage with the input grounded.

Note 2. Short-Circuit Current, I_{SC}, is adjustable by varying R₁, R₂, R₃ and R₄. The positive current limit is set by R₁ or R₃, and the negative current limit is set by R₂ or R₄. See Figures 4 and 5 for curves of short-circuit current versus R₁, R₂, R₃ and R₄.

Note 3. V_{CC} = +15 V, V_{EE} = -15 V.

6

MC1438R, MC1538R

FIGURE 1

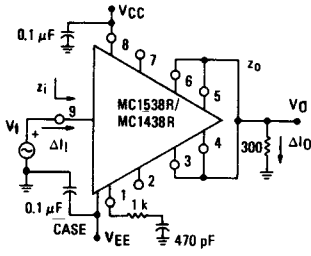

TEST CIRCUITS

FIGURE 2

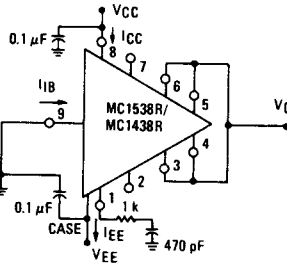
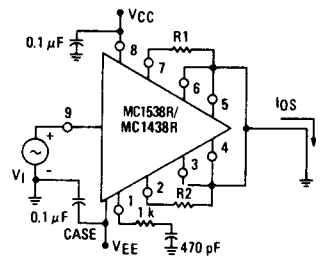
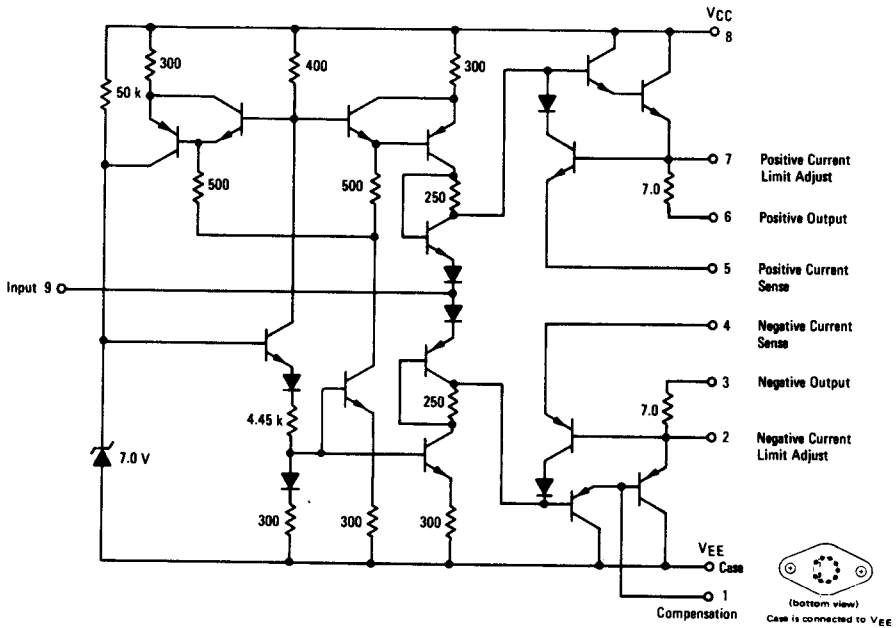

FIGURE 3



CIRCUIT SCHEMATIC



TYPICAL CHARACTERISTICS

($V_{CC} = +15 \text{ Vdc}$, $V_{EE} = -15 \text{ Vdc}$, $T_A = +25^\circ\text{C}$ unless otherwise noted.)

FIGURE 4 – SHORT-CIRCUIT CURRENT versus R1 OR R2
(100 mA to 300 mA)

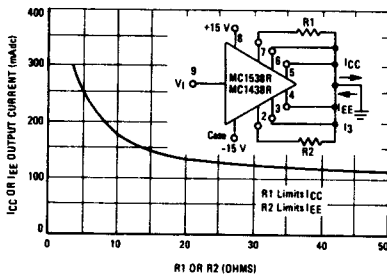
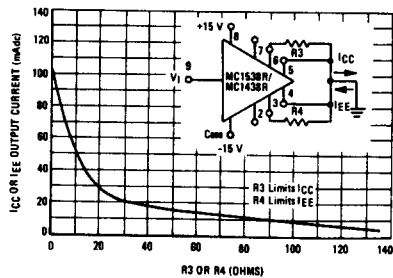

FIGURE 5 – SHORT-CIRCUIT CURRENT versus R3 OR R4
(5.0 mA to 100 mA)



TYPICAL CHARACTERISTICS (continued)

FIGURE 6 — POWER SUPPLY CURRENT versus SHUNT RESISTANCE

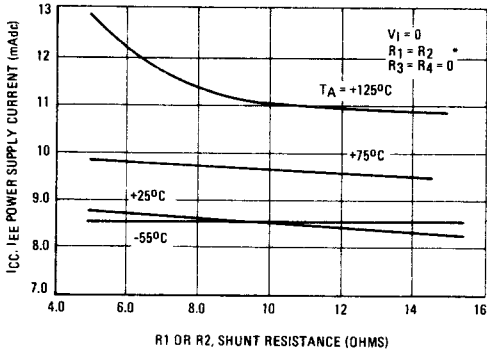

FIGURE 7 — SMALL SIGNAL GAIN AND PHASE RESPONSE

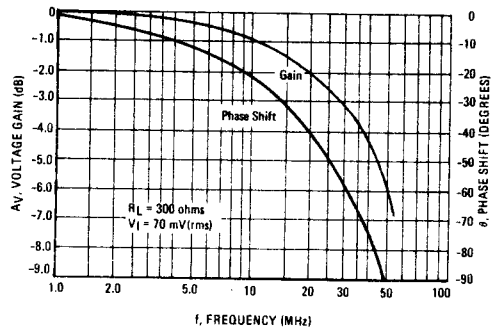

FIGURE 8 — POSITIVE OUTPUT VOLTAGE SWING versus LOAD CURRENT

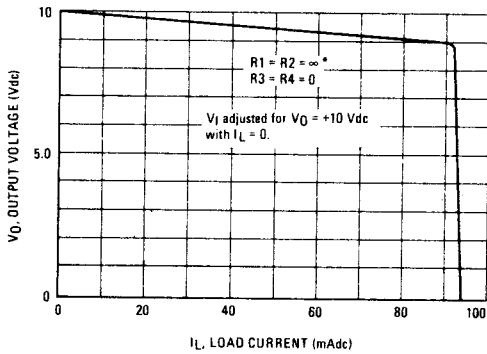

FIGURE 9 — NEGATIVE OUTPUT VOLTAGE SWING versus LOAD CURRENT

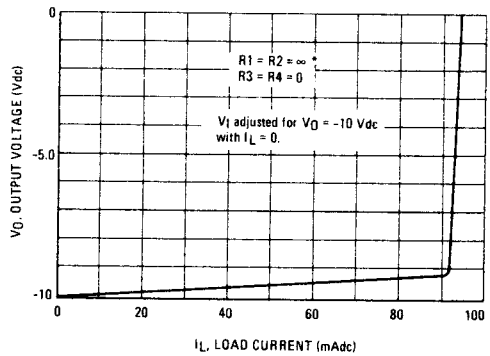

FIGURE 10 — OUTPUT OFFSET VOLTAGE versus TEMPERATURE

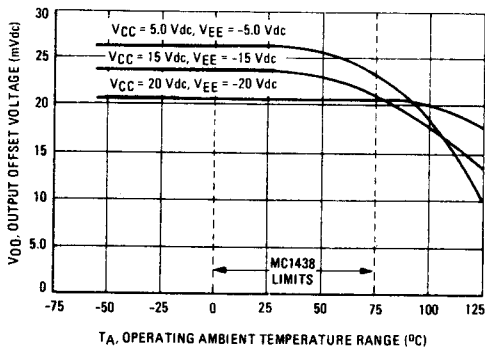
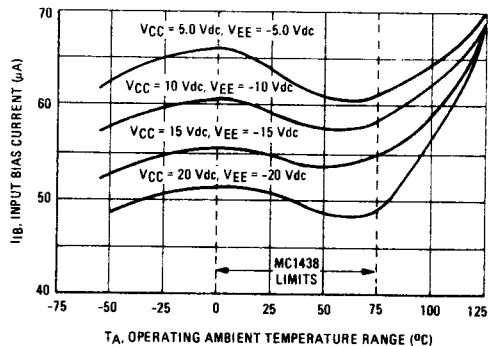

FIGURE 11 — INPUT BIAS CURRENT versus TEMPERATURE



*See figures 4 and 5 for definition of R_1 , R_2 , R_3 , and R_4 .

MC1438R, MC1538R

TYPICAL CHARACTERISTICS (continued)
 ($V_{CC} = +15$ Vdc, $V_{EE} = -15$ Vdc, $T_A = +25^\circ\text{C}$ unless otherwise noted.)

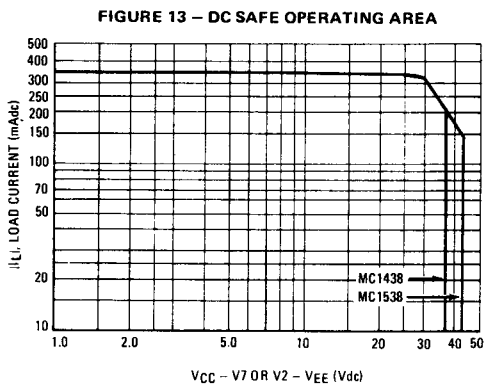
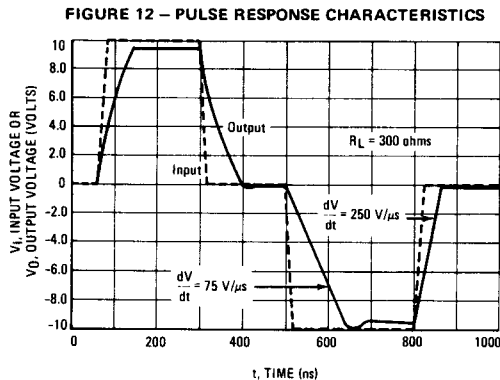

TYPICAL APPLICATIONS

FIGURE 14 – NON-INVERTING AC POWER AMPLIFIER

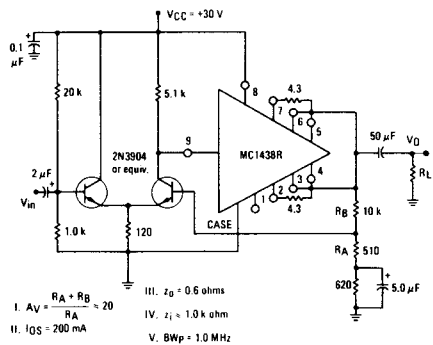

FIGURE 15 – NON-INVERTING POWER AMPLIFIER

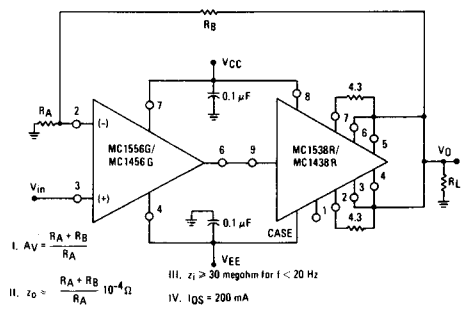

FIGURE 16 – NON-INVERTING VOLTAGE FOLLOWER

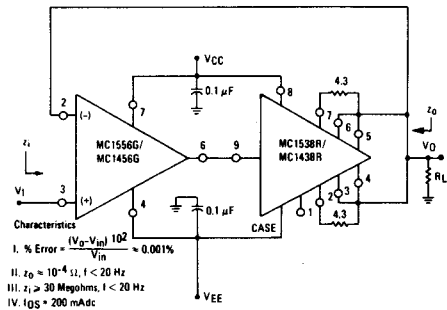
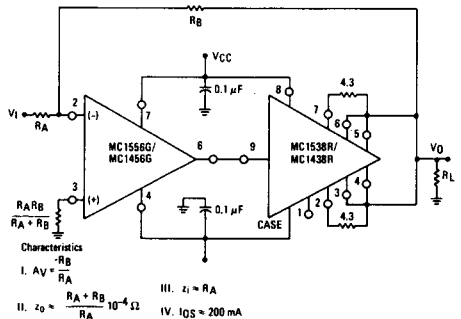

FIGURE 17 – INVERTING POWER AMPLIFIER



6

MC1438R, MC1438R

TYPICAL APPLICATIONS (continued)

FIGURE 18 – PROGRAMMABLE VOLTAGE SOURCE

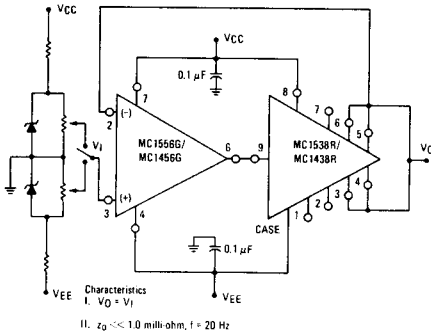

FIGURE 19 – CONSTANT CURRENT SOURCE OR TRANSCONDUCTANCE AMPLIFIER

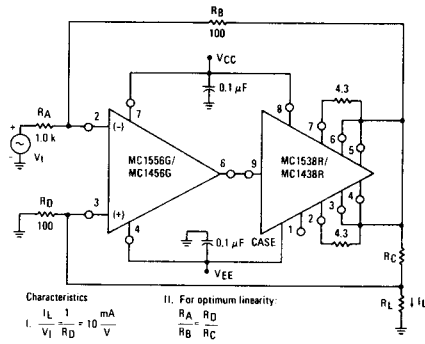

FIGURE 20 – SIGNAL DISTRIBUTION

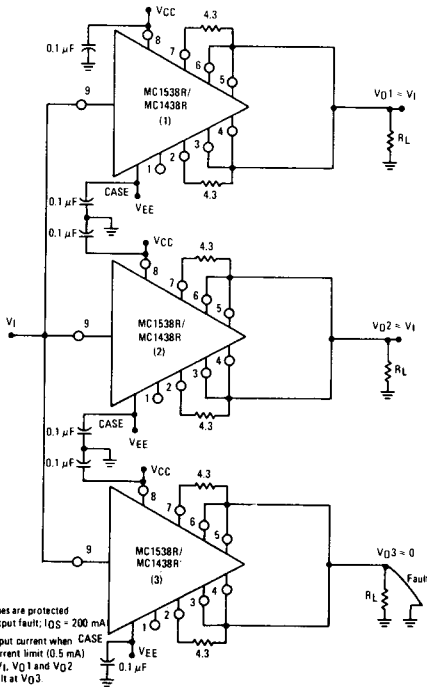

FIGURE 21 – ASTABLE MULTIVIBRATOR

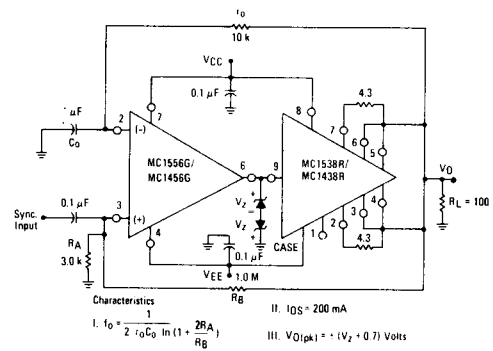

FIGURE 22 – WIEN BRIDGE OSCILLATOR

