

*Advance Information*

**Low-Power Comparators plus  
 Alarm-Driver Circuitry  
 CMOS**

The MC14471 contains both digital and analog components for use as an alarm driver. The device consists of three comparators: one for the detection of an alarm condition, one to detect a low battery, and one to track the voltage of the alarm-detect input, without loading that input down. An on-chip oscillator is provided, which requires two external passive components. The part also contains circuitry to drive an external piezoelectric horn and a visible LED.

This device is used in any equipment that requires a battery-operated audible and/or visual alarm. The MC14471 operates in one of four possible environmental conditions: (1) no alarm condition/no low battery, (2) alarm condition/no low battery, (3) no alarm condition/low battery, and (4) alarm condition/low battery. While in the no alarm/no low battery condition, the status of the detect inputs are checked every 1.67 seconds. If an alarm/good battery condition exists, the detect inputs are sampled every 40 ms and the alarm is sounded. In this mode, the horn is repeatedly on for 160 ms and off for 80 ms and the LED flashes every 0.96 second until the alarm status goes away. If a no alarm/low battery condition is present, the detect inputs again are checked every 1.67 seconds and the horn and LED outputs are activated every 40 seconds with an on time of 10 ms. Lastly, during the alarm/low battery condition, the detect inputs are sampled every 40 ms, the horn sounds, and the LED flashes once per 0.96 second.

The trip point for the alarm input is typically 50% of  $V_{DD}$ , while the trip point of the low-battery input is established by an on-chip zener diode. These thresholds can be altered over a limited range with the use of external resistors connected to either  $V_{SS}$  or  $V_{DD}$ .

Applications for the MC14471 include liquid level detectors, soil moisture-content detectors, and virtually any situation in which an alarm is needed.

- Piezoelectric Horn Driver
- Guard Outputs on Both Sides of Alarm Detect Input
- Comparator Outputs for Alarm Detect and Low Battery
- Internal Reverse Battery Protection
- Electrostatic Discharge (ESD) and Latch-Up Protection Circuitry on All Pins
- Pin-for-Pin Compatible with the MC14467P1, without  $\pm 1.0$  pA Leakage Testing or UL217 Compatibility
- Operating Voltage Range: 6 to 12 V
- Average Supply Current: 12  $\mu$ A
- Operating Temperature Range: -10 to 60°C
- Chip Complexity: 239 FETs

**MC14471**

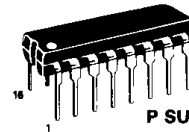

P SUFFIX  
 PLASTIC  
 CASE 648

**ORDERING INFORMATION**

MC14471P PDIP

**PIN ASSIGNMENT**

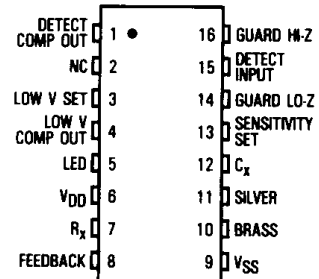

This document contains information on a new product. Specifications and information herein are subject to change without notice.

BLOCK DIAGRAM

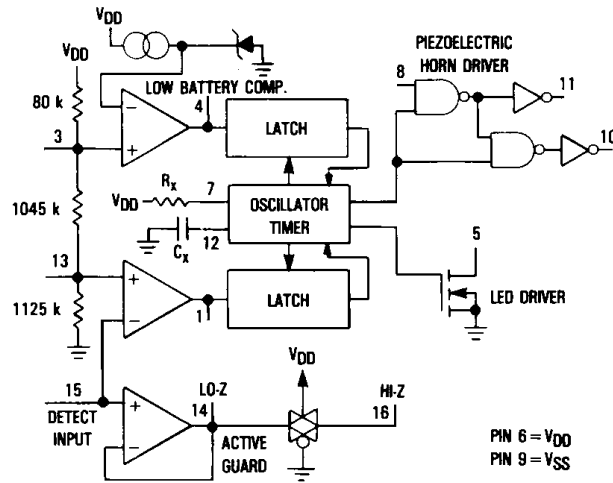

4

MAXIMUM RATINGS\* (Voltages Referenced to VSS)

| Symbol           | Parameter                                       | Value                           | Unit |
|------------------|---|---------------------------------|------|
| V <sub>DD</sub>  | DC Supply Voltage                               | -0.5 to +15                     | V    |
| V <sub>in</sub>  | DC Input Voltage, All Inputs Except Pin 8       | -0.25 to V <sub>DD</sub> + 0.25 | V    |
| i <sub>in</sub>  | DC Input Current, per Pin, Except Pin 15 = 1 mA | ± 10                            | mA   |
| i <sub>out</sub> | DC Output Current, per Pin                      | ± 30                            | mA   |
| T <sub>stg</sub> | Storage Temperature                             | -55 to +125                     | °C   |
| T <sub>L</sub>   | Lead Temperature, 1 mm from Case for 10 Seconds | 260                             | °C   |
| t <sub>RB</sub>  | Reverse Battery Time                            | 5.0                             | s    |

This device contains protection circuitry to guard against damage due to high static voltages or electric fields. However, precautions must be taken to avoid applications of any voltage higher than maximum rated voltages to this high-impedance circuit. For proper operation, V<sub>in</sub> and V<sub>out</sub> should be constrained to the range V<sub>SS</sub> ≤ (V<sub>in</sub> or V<sub>out</sub>) ≤ V<sub>DD</sub> except for pin 8, which can exceed V<sub>DD</sub>.  
 Unused inputs must always be tied to an appropriate logic voltage level (e.g., either V<sub>SS</sub> or V<sub>DD</sub>). Unused outputs must be left open.

\*Maximum Ratings are those values beyond which damage to the device may occur. Functional operation should be restricted to the limits in the Electrical Characteristics tables.

RECOMMENDED OPERATING CONDITIONS (Voltages Referenced to VSS)

| Symbol          | Parameter                                       | Value      | Unit |
|-----------------|---|------------|------|
| V <sub>DD</sub> | DC Supply Voltage                               | 9.0        | V    |
| C <sub>x</sub>  | Timing Capacitor (Can Use Up to ±20% Tolerance) | 0.1        | μF   |
| R <sub>x</sub>  | Timing Resistor (Can Use Up to ±20% Tolerance)  | 8.2        | MΩ   |
| I <sub>ld</sub> | Battery Load (Resistor or LED)                  | 10         | mA   |
| T <sub>A</sub>  | Operating Temperature                           | -10 to +60 | °C   |

**ELECTRICAL CHARACTERISTICS** ( $T_A = 25^\circ\text{C}$ , Voltages Referenced to  $V_{SS}$ )

| Symbol    | Parameter                                  | Test Condition   | $V_{DD}$<br>V | Min        | Max                   | Unit          |
|-----------|--|--|---------------|------------|-----------------------|---------------|
| $V_{DD}$  | Power Supply Voltage Range                 |  | —             | 6.0        | 12                    | V             |
| $I_{DD}$  | Average Operating Supply Current           | $R_x = 8.20\text{ M}\Omega$  | 9.0<br>12.0   | —<br>—     | 9.0<br>12.0           | $\mu\text{A}$ |
| $V_{in}$  | Input Voltage Range, Pin 8                 |  | —             | -10        | $V_{DD} + 10$         | V             |
| $V_{th}$  | Supply Threshold Voltage, Low-Supply Alarm |  | —             | 7.2        | 7.8                   | V             |
| $V_{ref}$ | Smoke Comparator Reference Voltage         |  | —             | 47         | 53                    | % $V_{DD}$    |
| $V_{hys}$ | Hysteresis Voltage                         | Alarm Condition, Pin 13  | 9.0           | 75         | 150                   | mV            |
| $V_{CM}$  | Common Mode Voltage Range, Pin 15          |  | —             | 0.6        | $V_{DD} - 2$          | V             |
| $V_{OS}$  | Offset Voltage                             | Active Guard<br>Detect Comparator<br>$V_{in} = V_{DD}/2$   | 9.0<br>9.0    | —<br>—     | $\pm 100$<br>$\pm 50$ | mV            |
| $I_{in}$  | Input Current, Detect Input                | $V_{in} = V_{SS}$ or $V_{DD}$  | 9.0           | —          | $\pm 40$              | nA            |
| $C_{in}$  | Input Capacitance                          |  | —             | —          | TBD                   | pF            |
| $V_{OH}$  | High-Level Output Voltage                  | Piezoelectric Horn Drivers<br>Comparators<br>$I_{out} = -16\text{ mA}$<br>$I_{out} = -30\text{ }\mu\text{A}$ | 7.2<br>9.0    | 6.3<br>8.5 | —<br>—                | V             |
| $V_{OL}$  | Low-Level Output Voltage                   | Piezoelectric Horn Drivers<br>Comparators<br>$I_{out} = 16\text{ mA}$<br>$I_{out} = 30\text{ }\mu\text{A}$   | 7.2<br>9.0    | —<br>—     | 0.9<br>0.5            | V             |
| $V_{OL}$  | Low-Level Output Voltage                   | LED Driver<br>$I_{out} = 10\text{ mA}$   | 7.2           | —          | 3.0                   | V             |
| $Z_{out}$ | Output Impedance, Active Guard             | Lo-Z, Pin 14<br>Hi-Z, Pin 16   | 9.0<br>9.0    | —<br>—     | 10<br>1000            | k $\Omega$    |

**AC ELECTRICAL CHARACTERISTICS** ( $T_A = 25^\circ\text{C}$ ,  $V_{DD} = 9.0\text{ V}$ ,  $C_x = 0.10\text{ }\mu\text{F}$ ,  $R_x = 8.20\text{ M}\Omega$ , See Figure 4)

| Symbol             | Parameter            | Test Condition                              | Min                  | Typ        | Max       | Unit       |         |
|--------------------|----------------------|---|----------------------|------------|-----------|------------|---------|
| $1/f_{osc}$        | Oscillator Period    | Free-Running Sawtooth<br>Measured at Pin 12 | 1.34<br>32           | 1.67<br>40 | 2.0<br>48 | s<br>ms    |         |
| $t_r$              | Oscillator Rise Time |   | 8                    | 10         | 12        | ms         |         |
| $t_w(\text{Horn})$ | Horn Pulse Width     | During Alarm Condition                      | On<br>Off            | 120<br>60  | 160<br>80 | 208<br>104 | ms      |
| $t_w(\text{LED})$  | LED Pulse Width      | Between Pulses                              | On                   | 32         | 40        | 48         | s<br>ms |
| $t_w(\text{Horn})$ | Horn Pulse Width     | During Low Battery                          | On<br>Between Pulses | 8<br>32    | 10<br>40  | 12<br>48   | ms<br>s |

**DEVICE OPERATION****TIMING**

The internal oscillator of the MC14471 operates with a period of 1.67 seconds during no-alarm conditions. Each 1.67 seconds, internal power is applied to the entire IC and a check is made for an alarm state, except during LED pulse, Low Battery Alarm Chirp, or Horn Modulation (in alarm condition). Every 24 clock cycles a check is made for low battery by comparing  $V_{DD}$  to an internal zener voltage.

The oscillator capacitor should be of a low-leakage type because of the low-current oscillator employed. Lastly, the tolerance of the external timing components must be no greater than  $\pm 20\%$ .

**DETECT CIRCUITRY**

If an alarm is detected, the oscillator period becomes 40 ms and the piezoelectric horn oscillator circuit is enabled. The horn output is modulated 160 ms on, 80 ms off. During the off time, the alarm condition is again checked and inhibits further horn output if an alarm condition is not sensed. During the alarm condition the low battery alarm is inhibited, but the LED pulses at a 1.0 Hz rate.

An active guard is provided on both pins adjacent to the detect input. The voltage at these pins is within 100 mV of the input signal. This keeps surface leakage currents to a minimum and provides a method of measuring the input voltage without loading the detect input pin. The active guard op amp is not power strobed and thus gives constant protection from surface leakage currents. The Detect Input has internal diode protection against static damage.

**SENSITIVITY/LOW BATTERY THRESHOLDS**

Both the sensitivity threshold and the low battery voltage levels are set internally by a common voltage divider connected between  $V_{DD}$  and  $V_{SS}$ . These voltages can be altered by external resistors connected from pins 3 or 13 to either  $V_{DD}$  or  $V_{SS}$ . Due to the common voltage divider network, there is a slight interaction between the thresholds.

**TEST MODE**

Because the internal op amps and comparators are power strobed, adjustments for sensitivity or low battery level may be difficult and time consuming. By forcing pin 12 to  $V_{SS}$ ,

the power strobing is bypassed and the outputs, Pins 1 and 4, constantly show alarm/no alarm and good battery/low battery, respectively. Pin 1 =  $V_{DD}$  for smoke and Pin 4 =  $V_{DD}$  for low battery. In this mode and during the 10 ms power strobe, chip current rises to approximately 50  $\mu A$ .

**LED PULSE**

The 9-volt battery level is checked every 40 seconds during the LED pulse. The battery is loaded via a 10 mA pulse for

10 ms. If the LED is not used, it should be replaced with an equivalent resistor such that the battery loading remains at 10 mA.

**HYSTERESIS**

When an alarm is detected, the resistor/divider network that sets sensitivity is altered to increase sensitivity. This yields approximately 100 mV of hysteresis and reduces intermittent triggering.

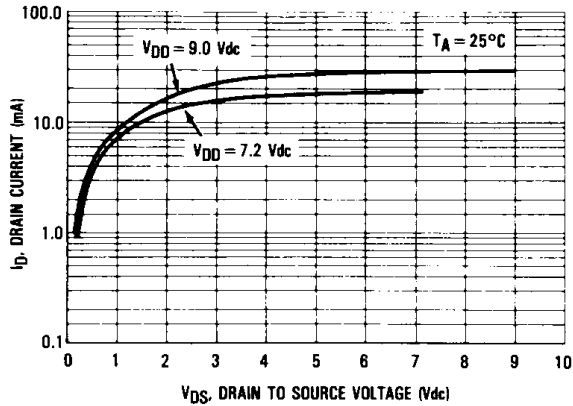

Figure 1. Typical LED Output I-V Characteristic

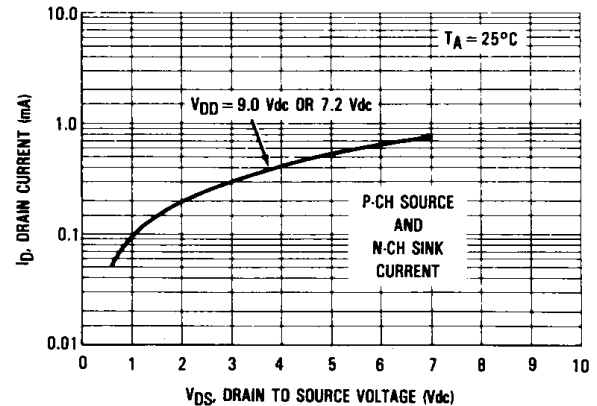

Figure 2. Typical Comparator Output I-V Characteristic

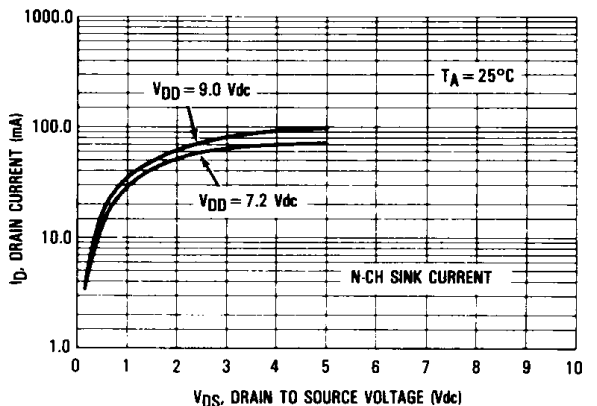
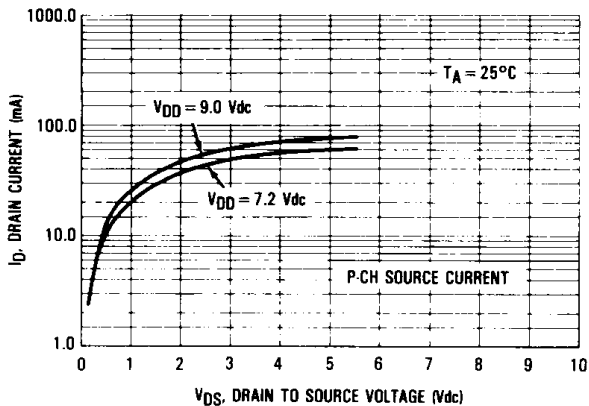
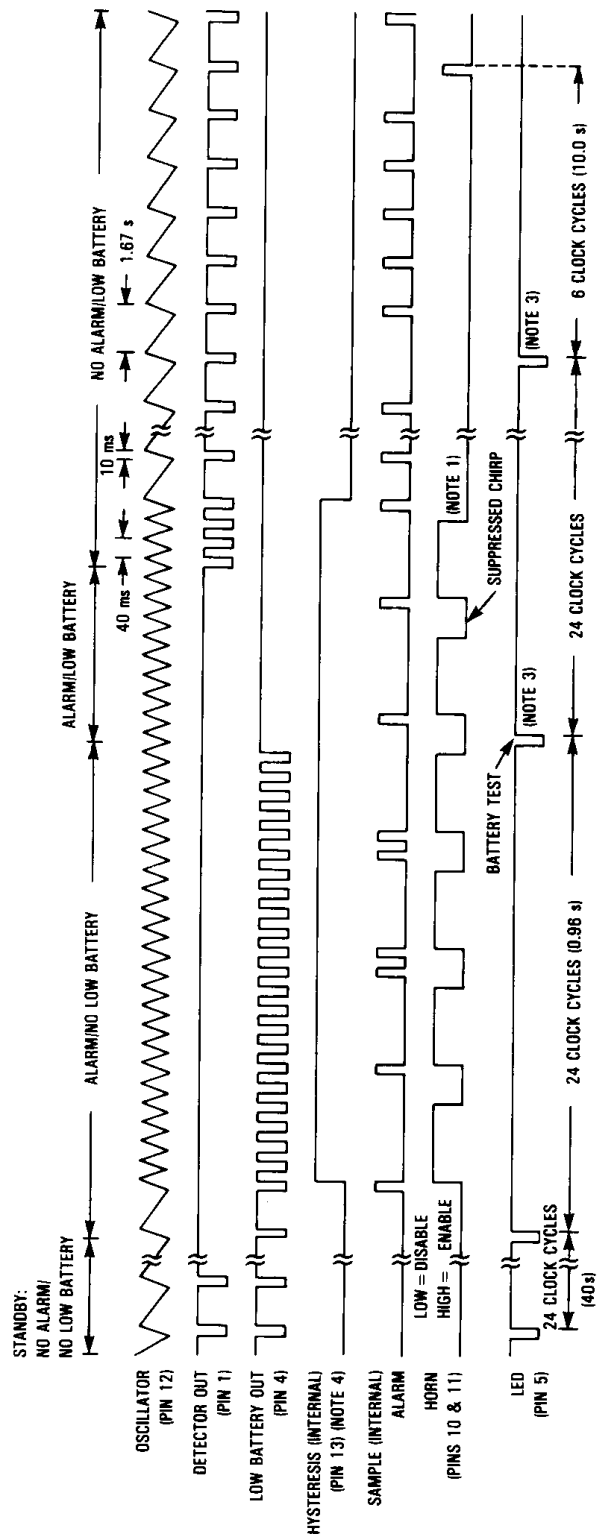

Figure 3. Typical P Horn Driver Output I-V Characteristic



- NOTES:
1. Horn modulation is self-completing. When going from alarm to no alarm, the alarm condition will terminate only when horn is off.
  2. Comparators are strobed on once per clock cycle (1.67 s for no alarm, 40 ms for alarm).
  3. Low battery comparator information is latched only during LED pulse.
  4. ~ 100 mVp-p swing.

Figure 4. Timing Diagram