

MC1456
MC1456C
MC1556

INTERNALLY COMPENSATED, HIGH PERFORMANCE OPERATIONAL AMPLIFIER

... designed for use as a summing amplifier, integrator, or amplifier with operating characteristics as a function of the external feedback components.

- Low Input Bias Current — 15 nA max
- Low Input Offset Current — 2.0 nA max
- Low Input Offset Voltage — 4.0 mV max
- Fast Slew Rate — 2.5 V/ μ s typ
- Large Power Bandwidth — 40 kHz typ
- Low Power Consumption — 45 mW max
- Offset Voltage Null Capability
- Output Short-Circuit Protection
- Input Over-Voltage Protection

TYPICAL INPUT BIAS CURRENT AND INPUT OFFSET CURRENT versus TEMPERATURE for MC1556

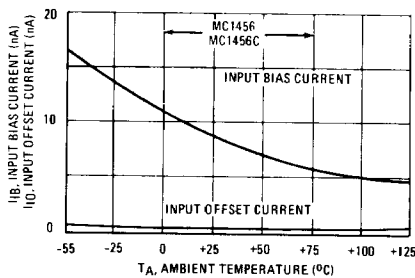

REPRESENTATIVE CIRCUIT SCHEMATIC

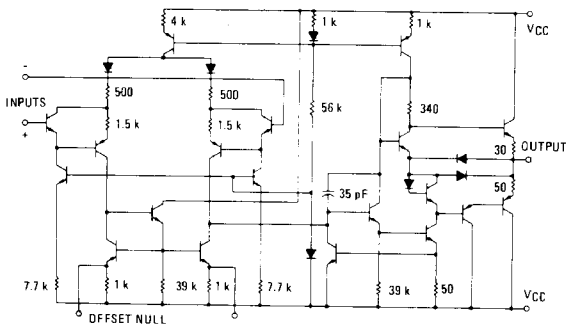

OPERATIONAL AMPLIFIER

SILICON MONOLITHIC INTEGRATED CIRCUIT

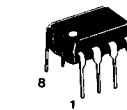
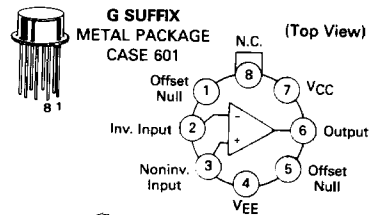

P1 SUFFIX
 PLASTIC PACKAGE
 CASE 626

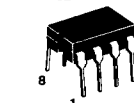

U SUFFIX
 CERAMIC PACKAGE
 CASE 693

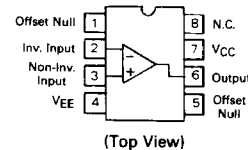

ORDERING INFORMATION

Device	Temperature Range	Package
MC1456G,CG MC1456CP1,P1	0°C to +70°C	Metal Can Plastic DIP
MC1556G MC1556U	-55°C to +125°C	Metal Can Ceramic DIP

VOLTAGE-FOLLOWER PULSE RESPONSE

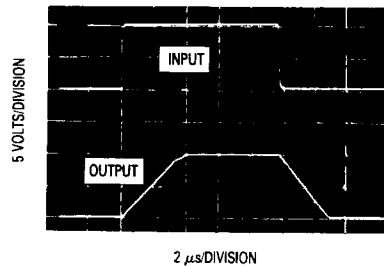

MC1456, MC1456C, MC1556

MAXIMUM RATINGS (T_A = +25°C unless otherwise noted)

Rating	Symbol	MC1456		Unit
		MC1556	MC1456C	
Power Supply Voltage	V _{CC} V _{EE}	+22 -22	+18 -18	Vdc
Differential Input Voltage Range	V _{IDR}	±V _{CC}		Volts
Common-Mode Voltage Range	V _{ICR}	±V _{CC}		Volts
Load Current	I _L	20		mA
Output Short Circuit Duration	t _S	Continuous		
Power Dissipation (Package Limitation) Derate above T _A = +25°C	P _D	680 4.6		mW mW/°C
Operating Temperature Range	T _A	-55 to +125	0 to +70	°C
Storage Temperature Range	T _{stg}	-65 to +150	-65 to +150	°C

ELECTRICAL CHARACTERISTICS (V_{CC} = +15 Vdc, V_{EE} = -15 Vdc, T_A = +25°C unless otherwise noted).

Characteristic	Fig.	Symbol	MC1556			MC1456			MC1456C			Unit
			Min	Typ	Max	Min	Typ	Max	Min	Typ	Max	
Input Bias Current T _A = +25°C T _A = T _{low} to T _{high} (See Note 1)		I _{IB}	-	8.0	15	-	15	30	-	15	90	nAdc
Input Offset Current T _A = +25°C T _A = +25°C to T _{high} T _A = T _{low} to +25°C		I _{IO}	-	1.0	2.0	-	5.0	10	-	5.0	30	nAdc
Input Offset Voltage T _A = +25°C T _A = T _{low} to T _{high}		V _{IO}	-	2.0	4.0	-	5.0	10	-	5.0	12	mVdc
Differential Input Impedance (Open-Loop, f = 20 Hz) Parallel Input Resistance Parallel Input Capacitance		r _p C _p	-	5.0 6.0	-	-	3.0 6.0	-	-	3.0 6.0	-	Megohms pF
Common-Mode Input Impedance (f = 20 Hz)		z _i	-	250	-	-	250	-	-	250	-	Megohms
Common-Mode Input Voltage Range	1	V _{ICR}	±12	±13	-	+11	±12	-	±10.5	±12	-	V _{pk}
Equivalent Input Noise Voltage (A _V = 100, R _S = 10 k ohms, f = 1.0 kHz, BW = 1.0 Hz)	2	e _n	-	45	-	-	45	-	-	45	-	nV/(Hz) ^{1/2}
Common-Mode Rejection Ratio (f = 100 Hz)	3	CMRR	80	110	-	70	110	-	-	110	-	dB
Open-Loop Voltage Gain, (V _O = ±10 V, R _L = 2.0 k ohms) T _A = +25°C T _A = T _{low} to T _{high}	4,5,6	A _{VOL}	100,000 40,000	200,000	-	70,000 40,000	100,000	-	25,000	100,000	-	V/V
Power Bandwidth (A _V = 1, R _L = 2.0 k ohms, THD ≤ 5%, V _O = 20 Vp-p)	9	BW _p	-	40	-	-	40	-	-	40	-	kHz
Unity Gain Crossover Frequency (open-loop)	5	BW	-	1.0	-	-	1.0	-	-	1.0	-	MHz
Phase Margin (open-loop, unity gain)	5,7		-	70	-	-	70	-	-	70	-	degrees
Gain Margin	5,7		-	18	-	-	18	-	-	18	-	dB
Slew Rate (Unity Gain)		SR	-	2.5	-	-	2.5	-	-	2.5	-	V/μs
Output Impedance (f = 20 Hz)		z _o	-	1.0	2.0	-	1.0	2.5	-	1.0	-	kohms
Short-Circuit Output Current	8	I _{OS}	-	-17, +9.0	-	-	-17, +9.0	-	-	-17, +9.0	-	mAde
Output Voltage Swing (R _L = 2.0 k ohms)	10	V _{OR}	±12	±13	-	+11	±12	-	±10	±12	-	V _{pk}
Power Supply Rejection Ratio V _{CC} = constant, R _S ≤ 10 k ohms V _{EE} = constant, R _S ≤ 10 k ohms		PSRR+ PSRR-	-	50 50	100	-	75 75	200 200	-	75 75	-	μV/V
Power Supply Current		I _{CC} I _{EE}	-	1.0 1.0	1.5	-	1.3 1.3	3.0 3.0	-	1.3 1.3	4.0 4.0	mAde
DC Quiescent Power Dissipation (V _O = 0)	11	P _D	-	30	45	-	40	90	-	40	120	mW

Note 1: T_{low}: 0° for MC1456 and MC1456C
-55°C for MC1556
T_{high}: +70°C for MC1456 and MC1456C
+125°C for MC1556

MC1456, MC1456C, MC1556

TYPICAL CHARACTERISTICS

($V_{CC} = +15\text{ Vdc}$, $V_{EE} = -15\text{ Vdc}$, $T_A = +25^\circ\text{C}$ unless otherwise noted).

FIGURE 1 – INPUT COMMON-MODE SWING versus POWER SUPPLY VOLTAGE

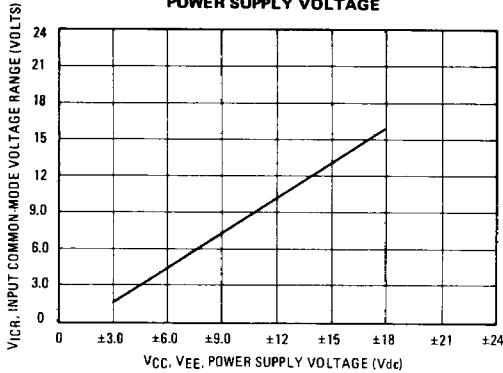

FIGURE 2 – SPECTRAL NOISE DENSITY

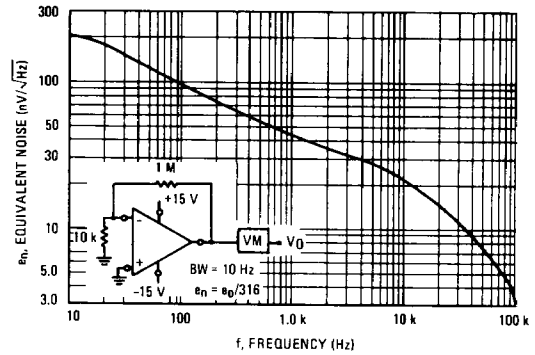

FIGURE 3 – COMMON-MODE REJECTION RATIO versus FREQUENCY

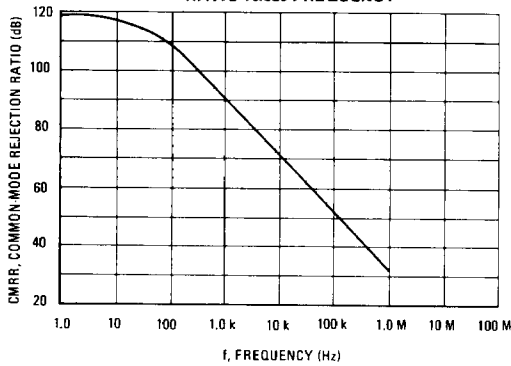

FIGURE 4 – OPEN-LOOP VOLTAGE GAIN versus TEMPERATURE

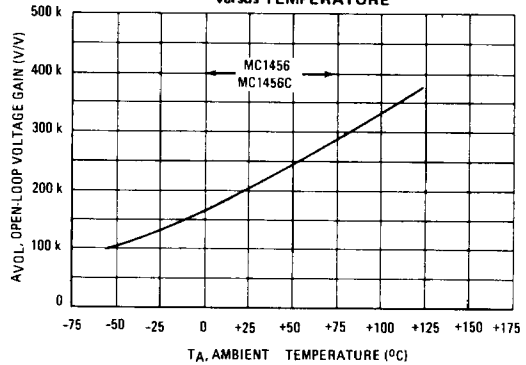

FIGURE 5 – OPEN-LOOP FREQUENCY RESPONSE

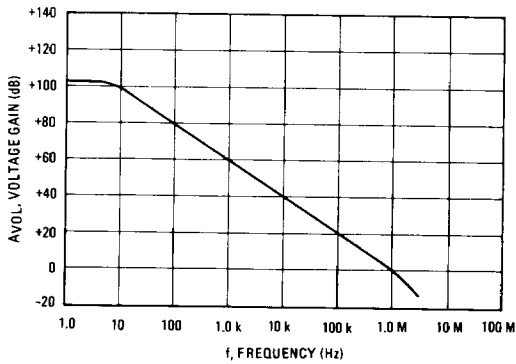
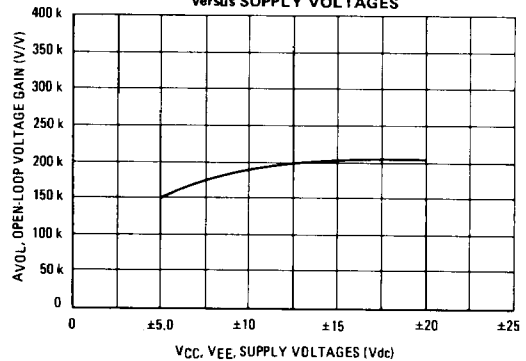

FIGURE 6 – OPEN-LOOP VOLTAGE GAIN versus SUPPLY VOLTAGES



MC1456, MC1456C, MC1556

TYPICAL CHARACTERISTICS (continued)

FIGURE 7 – OPEN-LOOP PHASE SHIFT

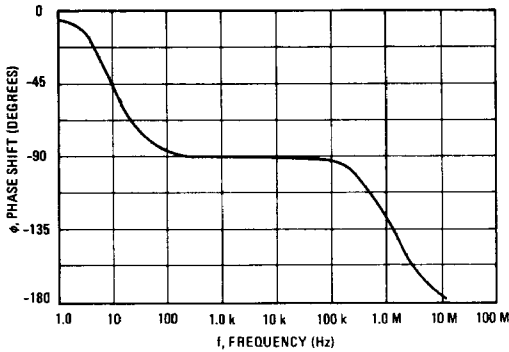

FIGURE 8 – OUTPUT SHORT-CIRCUIT CURRENT versus TEMPERATURE

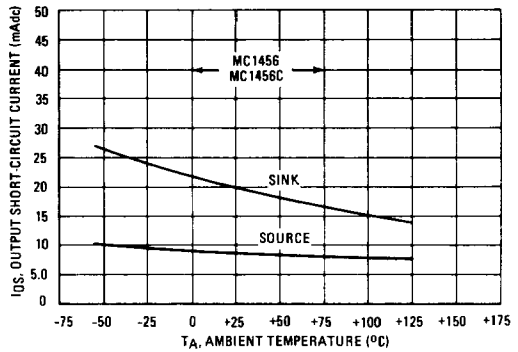

FIGURE 9 – POWER BANDWIDTH

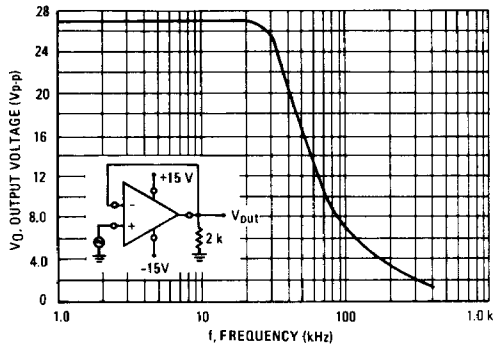

FIGURE 10 – OUTPUT VOLTAGE SWING versus LOAD RESISTANCE

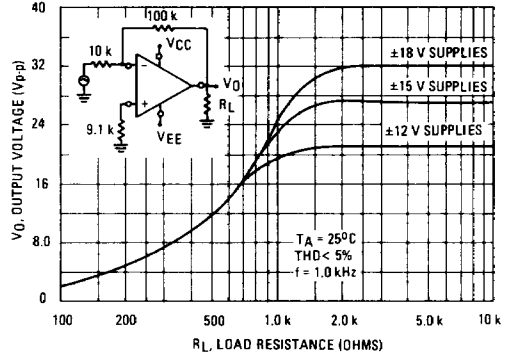
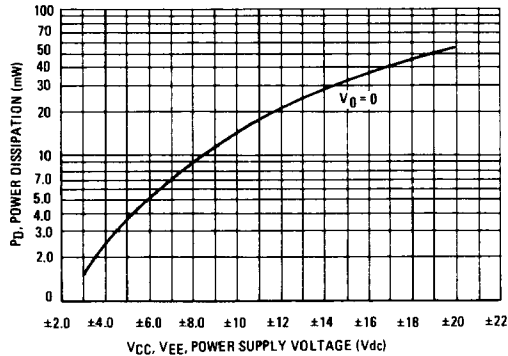

FIGURE 11 – POWER DISSIPATION versus POWER SUPPLY VOLTAGE



MC1456, MC1456C, MC1556

TYPICAL APPLICATIONS

Where values are not given for external components they must be selected by the designer to fit the requirements of the system.

FIGURE 12 — INVERTING FEEDBACK MODEL

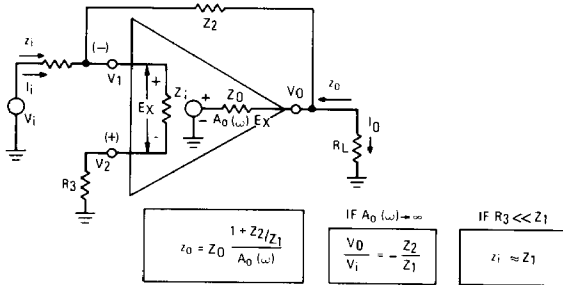

FIGURE 13 — NONINVERTING FEEDBACK MODEL

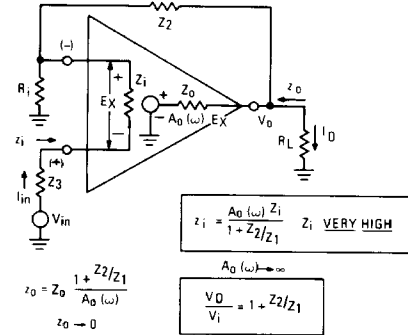

FIGURE 14 — LOW-DRIFT SAMPLE AND HOLD

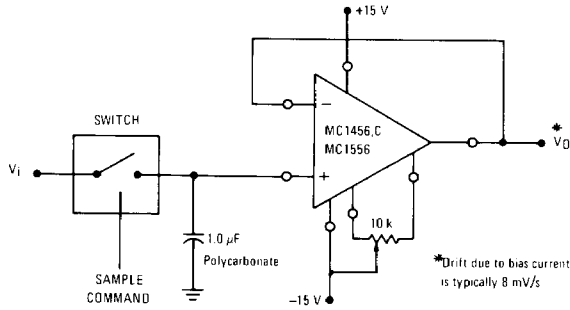
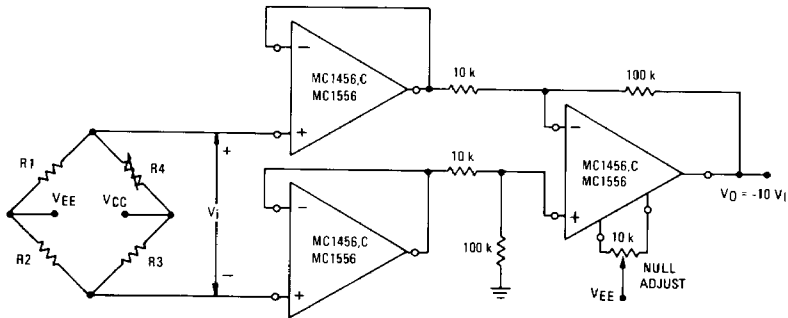

FIGURE 15 — HIGH IMPEDANCE BRIDGE AMPLIFIER



TYPICAL APPLICATIONS (continued)

FIGURE 16 – LOGARITHMIC AMPLIFIER

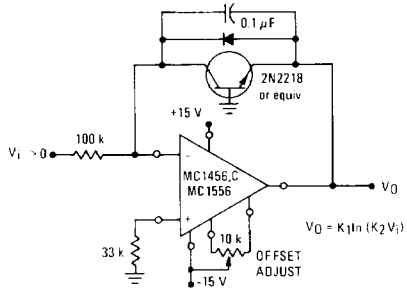

FIGURE 17 – VOLTAGE OFFSET NULL CIRCUIT

