

HIGH PERFORMANCE OPERATIONAL AMPLIFIER

MC1456/1556

DESCRIPTION

The MC1456/1556 is an internally compensated precision monolithic operational amplifier featuring extremely low offset and bias currents and offset null capability. The MC1456/1556 is short circuit protected and its high common mode and differential input voltage range provides exceptional performance when used as an integrator, summing amplifier, and voltage follower.

FEATURES

- Low input bias current—15nA maximum
- Low input offset current—2.0nA maximum
- Low input offset voltage—4.0mV maximum
- High slew rate—2.5V/ μ s typical
- Large power bandwidth—40kHz typical
- Low power consumption—45mW maximum
- Offset voltage null capability
- Output short circuit protection
- Input over-voltage protection
- MIL-STD-883A,B,C available

PIN CONFIGURATION

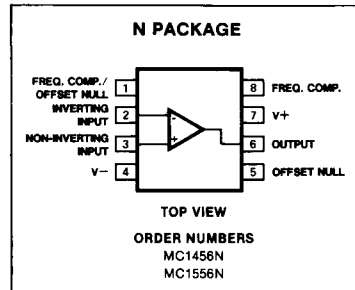

3

ABSOLUTE MAXIMUM RATINGS

PARAMETER	RATING	UNIT
Power supply voltage MC1556	± 22	V
MC1456	± 18	V
Differential input voltage	$\pm V_{CC}$	V
Common mode input voltage	$\pm V_{CC}$	V
Load current	20	mA
Output short circuit duration	Continuous	
Power dissipation	680	mW
Derate above $T_A = 25^\circ\text{C}$	4.6	mW/ $^\circ\text{C}$
Operating temperature range		
MC1556	-55 to +125	$^\circ\text{C}$
MC1456	0 to +70	$^\circ\text{C}$
Storage temperature range	-65 to +150	$^\circ\text{C}$

OFFSET ADJUST CIRCUIT

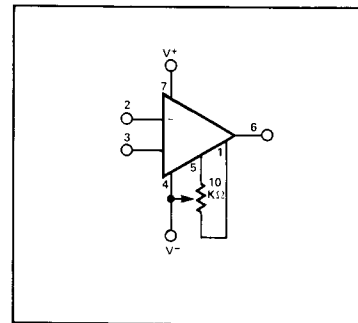

EQUIVALENT SCHEMATIC

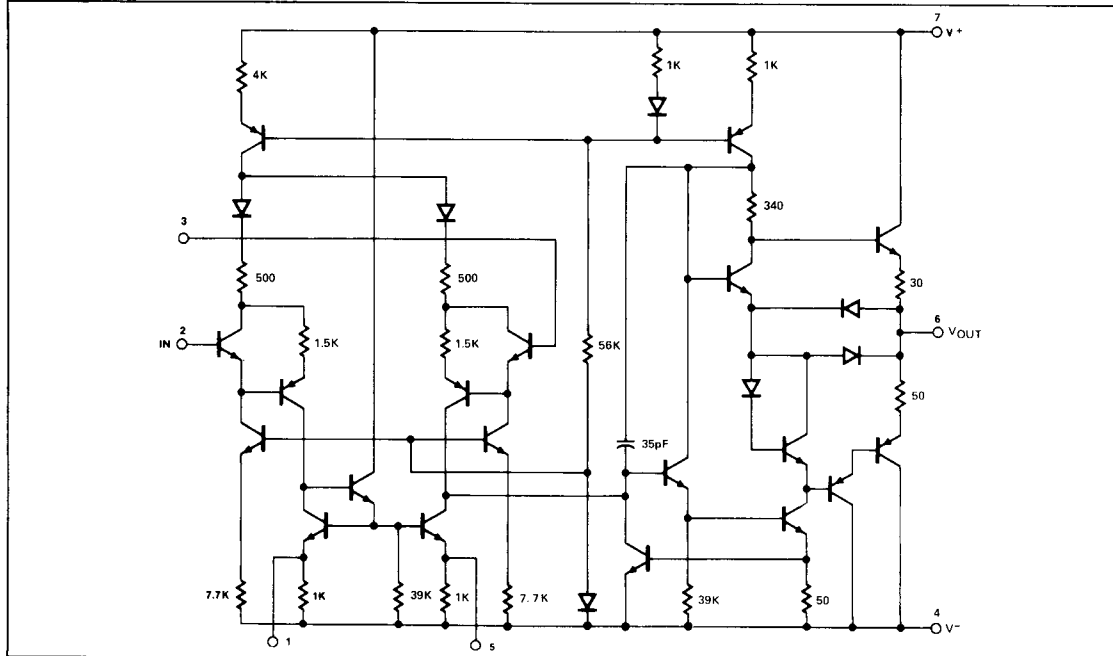

HIGH PERFORMANCE OPERATIONAL AMPLIFIER

MC1456/1556

DC ELECTRICAL CHARACTERISTICS $T_A = 25^\circ\text{C}$, $V_S = \pm 15\text{V}$ unless otherwise specified

PARAMETER	TEST CONDITIONS	MC1556			MC1456			UNIT
		Min	Typ	Max	Min	Typ	Max	
V_{OS} Offset voltage	Over temperature		2.0	4.0 6.0		5.0	10.0 14.0	mVdc mVdc
I_{OS} Offset current	$0^\circ\text{C} \leq T_A \leq 70^\circ\text{C}$ $25^\circ\text{C} \leq T_A \leq 125^\circ\text{C}$ $-55^\circ\text{C} \leq T_A \leq 25^\circ\text{C}$		1.0	2.0 3.0 5.0		5.0	10.0 14	nA nA nA nA
I_{BIAS} Input current	Over temperature		8.0	15 30		15.0	30.0 40	nA nA
V_{CM} Common mode voltage range	$R_S \leq 10\text{k}\Omega$, $T_A = 25^\circ\text{C}$, $f = 100\text{Hz}$	± 12	± 13		± 11	± 12		V
CMRR Common mode rejection ratio		80	110		70	110		dB
Z_{IN} Common mode input impedance		$f = 20\text{Hz}$		250			250	
V_{OUT} Output voltage swing	$R_L = 2\text{k}\Omega$	± 12	± 13		± 11	± 12		V
I_{CC} Supply current			1.0	1.5		1.3	3.0	mA
P_D DC quiescent power dissipation ($V_O = 0$)			30	45		40	90	mW
PSRR Supply voltage rejection ratio	$R_S \leq 10\text{k}\Omega$		50	100		75	200	$\mu\text{V/V}$
Large signal voltage gain	$R_L \leq 2\text{k}\Omega$, $V_{OUT} = \pm 10\text{V}$, $T_A = 25^\circ\text{C}$ Over temperature	100 40	200		70 40	100		V/mV V/mV

AC ELECTRICAL CHARACTERISTICS $T_A = 25^\circ\text{C}$, $V_S = \pm 15\text{V}$ unless otherwise specified.

PARAMETER	TEST CONDITIONS	MC1556			MC1456			UNIT
		Min	Typ	Max	Min	Typ	Max	
C_p Differential input impedance	Open loop $f = 20\text{Hz}$		6.0			6.0		pF
r_p Parallel input capacitance			5			3		M Ω
e_n Parallel input resistance				45			45	$\text{nV}/\sqrt{\text{Hz}}$
e_n Equivalent input noise voltage	$A_V = 100$, $R_S = 10\text{k}\Omega$, $f = 1.0\text{kHz}$, $BW = 1.0\text{kHz}$		45			45		$\text{nV}/\sqrt{\text{Hz}}$
BW_p Power bandwidth	$A_V = 1$, $R_L = 2\text{k}\Omega$, THD $\leq 5\%$ $V_{OUT} = \pm 10\text{V}$		40			40		kHz
Phase margin (open loop, unity gain)			70			70		degrees
Gain margin			18			18		dB
SR Slew rate (unity gain)			2.5			2.5		V/ μsec
Z_{OUT} Output impedance	$f = 20\text{Hz}$		1.0	2.0		1.0	2.5	k Ω
BW Unity gain crossover frequency (open loop)				1.0			1.0	MHz

HIGH PERFORMANCE OPERATIONAL AMPLIFIER

MC1456/1556

TYPICAL PERFORMANCE CHARACTERISTICS

**POWER DISSIPATION vs
POWER SUPPLY VOLTAGE**

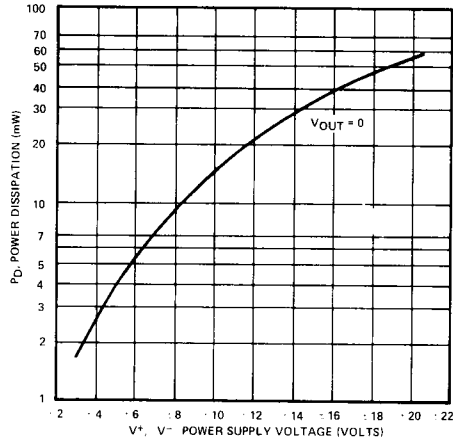

**POWER
BANDWIDTH**

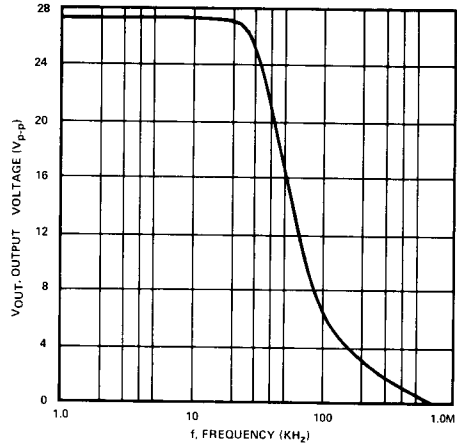

**TYPICAL INPUT BIAS CURRENT AND
INPUT OFFSET CURRENT vs
TEMPERATURE FOR MC1556**

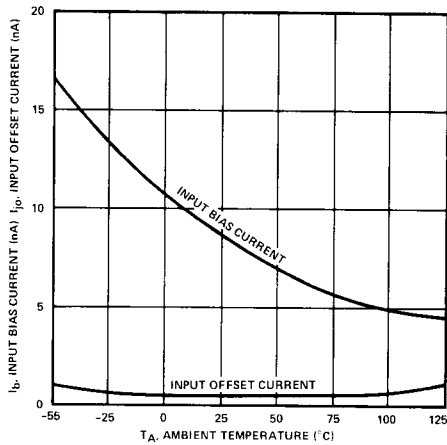

**VOLTAGE FOLLOWER
PULSE RESPONSE**

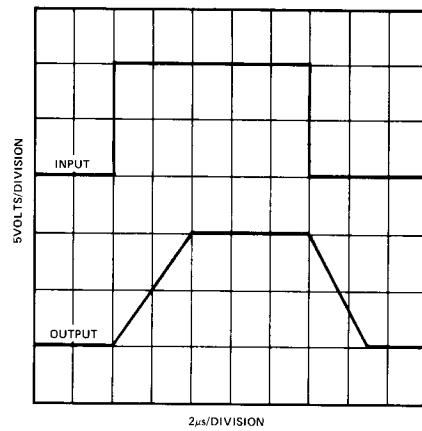

3