

MC830 Series (0 to +75°C)
MC930 Series (-55 to +125°C)

ISSUE A

MAXIMUM RATINGS

Rating	Value	Unit
Supply Voltage –		Vdc
Operating	4.5 to 5.5	
Continuous	8.0	
Pulsed, < 1 second	12	
Output Current (Into Outputs with Outputs Low)		mAdc
Buffers, Power Gates – Continuous	100	
Pulsed, < 30 ms	300	
All other types – Continuous	30	
Pulsed, < 30 ms	90	
Input Forward Current –		mAdc
Continuous	-10	
Pulsed, < 30 ms	-30	
or		Vdc
Negative Voltage at Input –		
Continuous	-0.5	
Pulsed, < 30 ms	-1.5	
Input Reverse Current	1.0	mAdc
or		Vdc
Positive Voltage at Diode Input	5.5	
Operating Temperature Range		°C
MC930 Series	-55 to +125	
MC830 Series	0 to +75	
Storage Temperature Range		°C
Metal Can, Ceramic Package	-65 to +150	
Plastic Package	-55 to +125	
Maximum Junction Temperature		°C
MC930 Series	175	
MC830 Series	150	

MDTL integrated circuits provide an excellent balance of speed, power dissipation, and noise immunity for general purpose digital applications. The line includes many multifunction types. Additional logic power is provided by the "wired OR" capability of the basic MDTL gate.

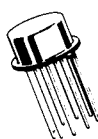

G SUFFIX
METAL PACKAGE
CASE 603-02
TO-100

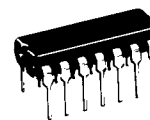

P SUFFIX
PLASTIC PACKAGE
CASE 646



F SUFFIX
CERAMIC PACKAGE
CASE 607

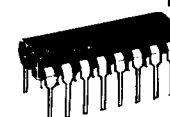

P SUFFIX
PLASTIC PACKAGE
CASE 648

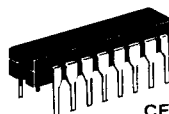

L SUFFIX
CERAMIC PACKAGE
CASE 620

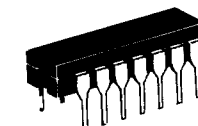

L SUFFIX
CERAMIC PACKAGE
CASE 632
TO-116

FUNCTIONS AND CHARACTERISTICS (V_{CC} = 5.0 Vdc, T_A = 25°C)

Function	Type ① 0 to +75°C	Case	Type ① -55 to +125°C	Case	Loading Factor Each Output	Propaga- tion Delay ns typ	Power Dissipation mW typ/pkg
Expandable Dual 4-Input NAND Gate	MC830	607,632,646	MC930	607,632	8	30	22
Expandable Dual 3-2-Input NAND Gate	MC830	603	MC930	603	8	30	22
Expandable Dual 4-Input Buffer	MC832	607,632,646	MC932	607,632	25	35	85
Expandable Dual 3-2-Input Buffer	MC832	603	MC932	603	25	35	85
Dual 4-Input Expander	MC833	607,632,646	MC933	607,632	–	–	–
Dual 4-3-Input Expander	MC833	603	MC933	603	–	–	–
Hex Inverter	MC834	607,632,646	MC934	607,632	8	30	66
Hex Inverter (without output resistors)	MC835	607,632,646	MC935	607,632	8	30	42
Hex Inverter	MC836	607,632,646	MC936	607,632	8	30	66
Hex Inverter	MC837	607,632,646	MC937	607,632	7	25	90
Decade Counter	MC838	607,632,646	MC938	607,632	8	30 MHz ③	150
Divide-by-Sixteen Counter	MC839	607,632,646	MC939	607,632	8	30 MHz ③	150
Hex Inverter (without input diodes)	MC840	607,632,646	MC940	607,632	8	30	66
Hex Inverter (without output resistors and input diodes)	MC841	607,632,646	MC941	607,632	8	30	42
Expandable Dual 4-Input Power Gate	MC844	607,632,646	MC944	607,632	27	30	65
Expandable Dual 3-2-Input Power Gate	MC844	603	MC944	603	27	30	65
Clocked Flip-Flop	MC845	603,607,632,646	MC945	603,607,632	12/10 ②	40	60
Quad 2-Input NAND Gate	MC846	607,632,646	MC946	607,632	8	30	44
Quad Inverter	MC846	603	MC946	603	8	30	44
Quad 2-Input Gate Expander	MC847	607,632,646	MC947	607,632	–	–	–
Clocked Flip-Flop	MC848	603,607,632,646	MC948	603,607,632	11/9 ②	40	70
Quad 2-Input NAND Gate (2 k pullup resistor)	MC849	607,632,646	MC949	607,632	7	25	66
Quad Inverter (2 k pullup resistor)	MC849	603	MC949	603	7	25	60
Pulse Triggered Binary Monostable Multivibrator	MC850	603,607,632,646	MC950	603,607,632	10/8 ②	15	50
Dual J-K Flip-Flop (common clock and C _D , separate S _D)	MC851	603,607,632,646	MC951	603,607,632	10	40	30
Dual J-K Flip-Flop (separate clock and S _D , no C _D)	MC852	607,632,646	MC952	607,632	12/10 ②	40	120
	MC853	607,632,646	MC953	607,632	12/10 ②	40	120

① F suffix denotes Ceramic Flat Package, G suffix denotes Metal Can, L suffix denotes Dual In-Line Ceramic Package, P suffix denotes Dual In-Line Plastic Package. (i.e., MC830G = Metal Can, MC830F = Flat Package, MC830L = Dual In-Line Ceramic Package, MC830P = Plastic Package)

② Fan-out for MC830 series type / Fan-out for MC930 series type.

③ Counting frequency.

continued

MDTL (continued)

Function	Type ① 0 to +75°C	Case	Type ① -55 to +125°C	Case	Loading Factor Each Output	Propaga- tion Delay ns typ	Power Dissipation mW typ/pkg
Dual J-K Flip-Flop (common clock and C _D , separate S _D , 2 k pullup resistor)	MC855	607,632,646	MC955	607,632	11/9 ②	40	140
Dual J-K Flip-Flop (separate clock and S _D , no C _D , 2 k pullup resistor)	MC856	607,632,646	MC956	607,632	11/9 ②	40	140
Quad 2-Input Buffer	MC857	607,632,646	MC957	607,632	25	35	170
Quad 2-Input NAND Power Gate	MC858	607,632,646	MC958	607,632	27	30	130
Expandable Dual 4-Input NAND Gate (2 k pullup resistor)	MC861	607,632,646	MC961	607,632	7	25	33
Expandable Dual 3-2 Input NAND Gate (2 k pullup resistor)	MC861	603	MC961	603	7	25	33
Triple 3-Input NAND Gate	MC862	607,632,646	MC962	607,632	8	30	33
Dual 2-Input NAND Gate plus Inverter	MC862	603	MC962	603	8	30	30
Triple 3-Input NAND Gate (2 k pullup resistor)	MC863	607,632,646	MC963	607,632	7	25	50
Dual 2-Input NAND Gate plus Inverter (2 k pullup resistor)	MC863	603	MC963	603	7	25	45
Dual 5-Input NAND Gate (6K pullup resistor)	MC1800	607,632,646	MC1900	607,632	8	30	22
Dual 5-Input NAND Gate (2k pullup resistor)	MC1801	607,632,646	MC1901	607,632	7	25	33
Expandable 8-Input NAND Gate	MC1802	607,632,646	MC1902	607,632	8	30	11
Expandable 8-Input NAND Gate (2 k pullup resistor)	MC1803	607,632,646	MC1903	607,632	7	25	16.5
10-Input NAND Gate	MC1804	607,632,646	MC1904	607,632	8	30	11
10-Input NAND Gate (2k pullup resistor)	MC1805	607,632,646	MC1905	607,632	7	25	16.5
Quad 2-Input AND Gate	MC1806	607,632,646	MC1906	607,632	8	35	72
Quad 2-Input AND Gate (2k pullup resistor)	MC1807	607,632,646	MC1907	607,632	7	30	85
Quad 2-Input OR Gate	MC1808	607,632,646	MC1908	607,632	8	35	97
Quad 2-Input OR Gate (2k pullup resistor)	MC1809	607,632,646	MC1909	607,632	7	30	115
Quad 2-Input NOR Gate	MC1810	607,632,646	MC1910	607,632	8	30	60
Quad 2-Input NOR Gate (2k pullup resistor)	MC1811	607,632,646	MC1911	607,632	7	25	72
Quad 2-Input Exclusive OR Gate	MC1812	607,632,646	MC1912	607,632	8	40	120
Quad Latch	MC1813	620,648	—	—	7	35	220
Quad Latch	MC1814	607,632,646	MC1914	607,632	7	35	220
Parallel Gated Clocked Flip-Flop	MC1815	607,632,646	MC1915	607,632	12/10 ②	40	65
Parallel Gated Clocked Flip-Flop	MC1816	607,632,646	MC1916	607,632	11/9 ②	40	75
Quad 2-Input NAND Gate (without output resistor)	MC1818	607,632,646	MC1918	607,632	8	30	32
High Voltage Hex Inverter	MC1820	632,646	—	—	7	40	42

① F suffix denotes Ceramic Flat Package, G suffix denotes Metal Can, L suffix denotes Dual In-Line Ceramic Package, P suffix denotes Dual In-Line Plastic Package. (i.e., MC830G = Metal Can, MC830F = Flat Package, MC830L = Dual In-Line Ceramic Package, MC830P = Plastic Package)

② Fan-out for MC830 series type/Fan-out for MC930 series type.

③ Counting frequency.

*Unless otherwise noted

Case	Gnd* Pin No.	VCC* Pin No.
603	5	10
646	7	14
607	7	14
648	8	16
620	8	16
632	7	14

GATES

Numbers at ends of terminals represent pin numbers. Numbers in parenthesis indicate loading.

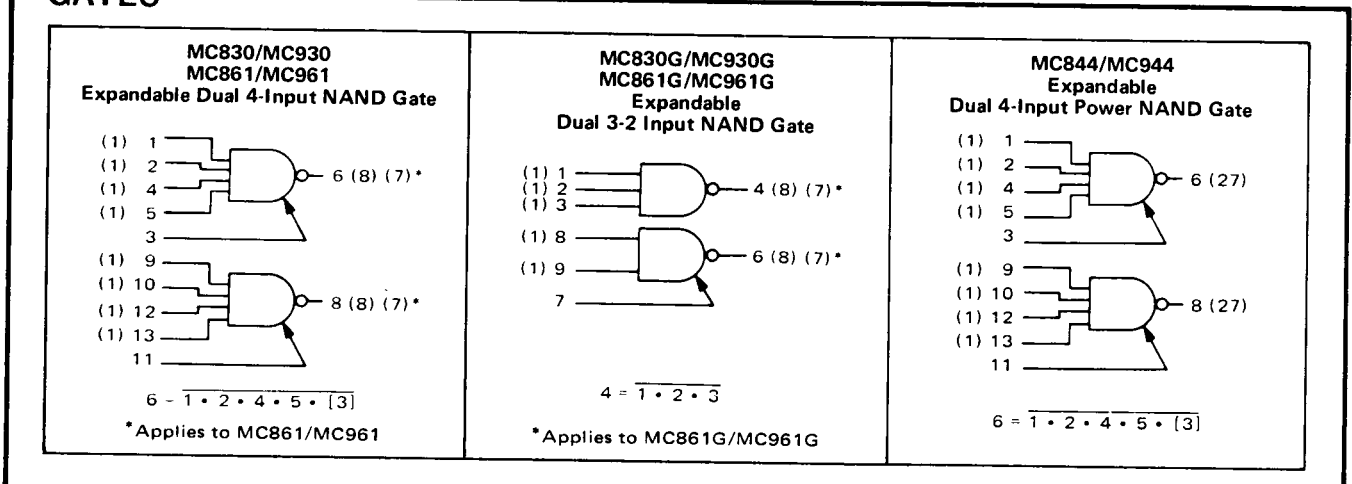

GATES (continued)

MC844G/MC944G
Expandable
Dual 3-2 Input NAND Power Gate

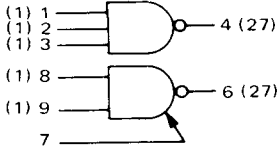

$$4 = \overline{1 \cdot 2 \cdot 3}$$

MC846/MC946
MC849/MC949
Quad 2-Input NAND Gate

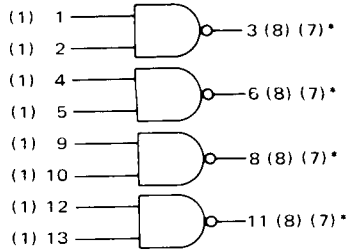

$$3 = \overline{1 \cdot 2}$$

* Applies to MC849/MC949

MC858/MC958
Quad 2-Input NAND Power Gate

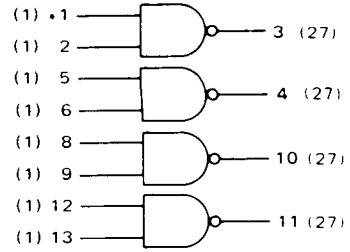

$$3 = \overline{1 \cdot 2}$$

MC862/MC962
MC863/MC963
Triple 3-Input NAND Gate

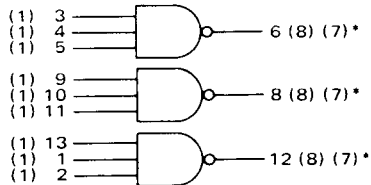

$$6 = \overline{3 \cdot 4 \cdot 5}$$

* Applies to MC863/MC963

MC862G/MC962G
MC863G/MC963G
Dual 2-Input NAND Gate
Plus Inverter

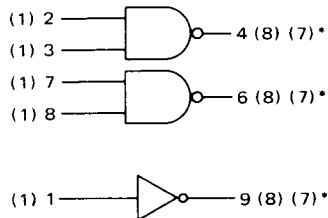

$$4 = \overline{2 \cdot 3}$$

$$6 = \overline{7 \cdot 8}$$

$$9 = \overline{1}$$

* Applies to MC863G/MC963G

MC1800/MC1900
MC1801/MC1901
Dual 5-Input NAND Gate

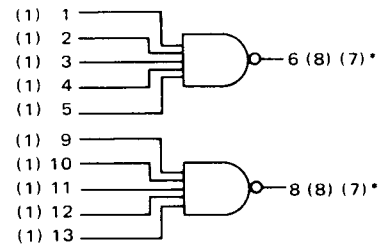

$$6 = \overline{1 \cdot 2 \cdot 3 \cdot 4 \cdot 5}$$

* Applies to MC1801/MC1901

MC1802/MC1902
MC1803/MC1903
Expandable 8-Input NAND Gate

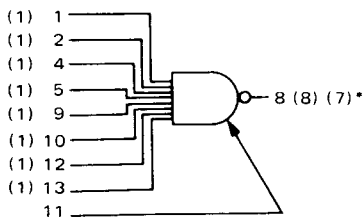

$$8 = \overline{1 \cdot 2 \cdot 4 \cdot 5 \cdot 9 \cdot 10 \cdot 12 \cdot 13 \cdot [11]}$$

* Applies to MC1803/MC1903

MC1804/MC1904
MC1805/MC1905
10-Input NAND Gate

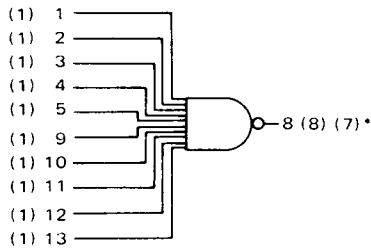

$$8 = \overline{1 \cdot 2 \cdot 3 \cdot 4 \cdot 5 \cdot 9 \cdot 10 \cdot 11 \cdot 12 \cdot 13}$$

* Applies to MC1805/MC1905

MC1806/MC1906
MC1807/MC1907
Quad 2-Input AND Gate

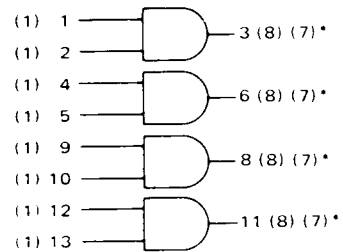

$$3 = 1 \cdot 2$$

* Applies to MC1807/MC1907

(continued)

GATES (continued)

MC1808/MC1908
MC1809/MC1909
Quad 2-Input OR Gate

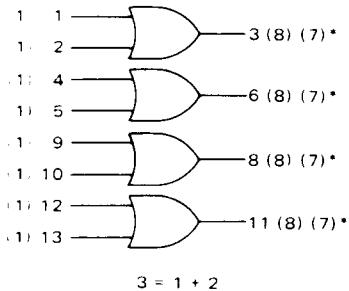

* Applies to MC1809/MC1909

MC1810/MC1910
MC1811/MC1911
Quad 2-Input NOR Gate

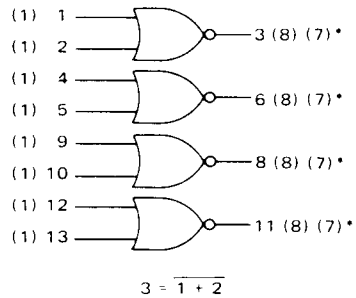

* Applies to MC1811/MC1911

MC1812/MC1912
Quad 2-Input Exclusive OR Gate

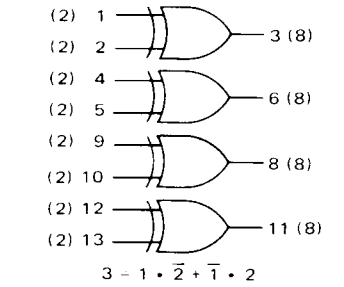

FUNCTIONAL LOGIC DIAGRAM

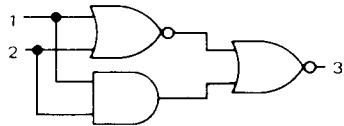

MC1818/MC1918
Quad 2-Input NAND Gate
(Without Output Resistors)

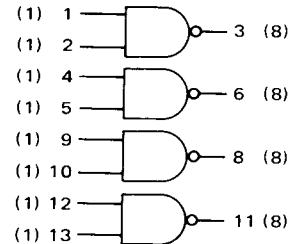

$3 = \overline{1 \cdot 2}$

MULTIVIBRATOR

MC851/MC951
Monostable Multivibrator

F, L, P, PACKAGES

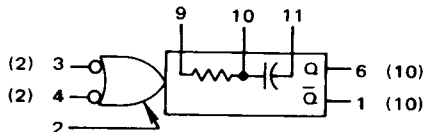

G PACKAGE
VCC = Pin 6, Gnd = Pin 1

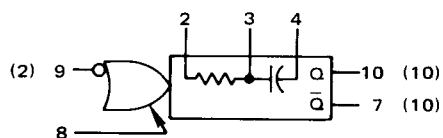

FLIP-FLOPS

www.DataSheet4U.com

MC845/MC945 MC848/MC948 Clocked Flip-Flop

F, L, & P PACKAGES

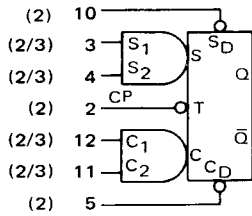

G PACKAGES

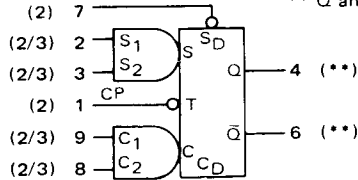

** Q and \bar{Q} loading factor: 12 for MC845 types
10 for MC945 types
11 for MC848 types
9 for MC948 types

SYNCHRONOUS TRUTH TABLE

t_n				t_{n-1}
S_1	S_2	C_1	C_2	Q
0	X	0	X	Q_n
0	X	X	0	Q_n
X	0	0	X	Q_n
X	0	X	0	Q_n
0	X	1	1	0
X	0	1	1	0
1	1	0	X	1
1	1	X	0	1
1	1	1	1	U

0 — Low State (more negative)
1 — High State (more positive)
X — State of the input does not affect the state of the circuit.
U — Indeterminate State

J-K TRUTH TABLE (Connect S_2 to \bar{Q} , C_2 to Q)

t_n		t_{n-1}
S_1	C_1	Q
0	0	Q_n
1	0	1
0	1	0
1	1	\bar{Q}_n

ASYNCHRONOUS TRUTH TABLE

S_D	C_D	Q	\bar{Q}
1	1	NC	NC
0	1	1	0
1	0	0	1
0	0	1	1

Asynchronous inputs, direct set (S_D) and direct clear (C_D), override the synchronous inputs: they are independent of all other inputs.

MC852/MC952 MC855/MC955 Dual J-K Flip-Flop

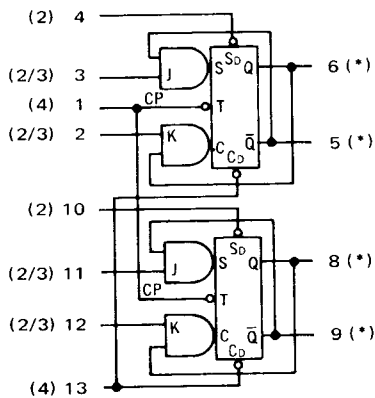

*Q and \bar{Q} loading factor:
12 — MC852
10 — MC952
11 — MC855
9 — MC955

ASYNCHRONOUS TRUTH TABLE MC952/MC852 and MC955/MC855

S_D	C_D	Q	\bar{Q}
1	1	NC	NC
0	1	1	0
1	0	0	1
0	0	1	1

ASYNCHRONOUS TRUTH TABLE MC953/MC853 and MC956/MC856

S_D	Q	\bar{Q}
1	NC	NC
0	1	0

Asynchronous inputs, direct set (S_D) and direct clear (C_D), override the synchronous inputs: they are independent of all other inputs.

J-K TRUTH TABLE All Types

t_n		t_{n-1}
J	K	Q
0	0	Q_n
1	0	1
0	1	0
1	1	\bar{Q}_n

J & K inputs must not change while clock is high.

MC853/MC953 MC856/MC956 Dual J-K Flip-Flop

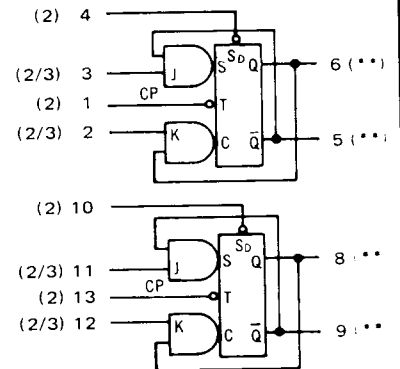

**Q and \bar{Q} loading factor
12 — MC853
10 — MC953
11 — MC856
9 — MC956

(cont. next)

MDTL LOGIC DIAGRAMS

FLIP-FLOPS (continued)

**MC1813
Quad Latch**

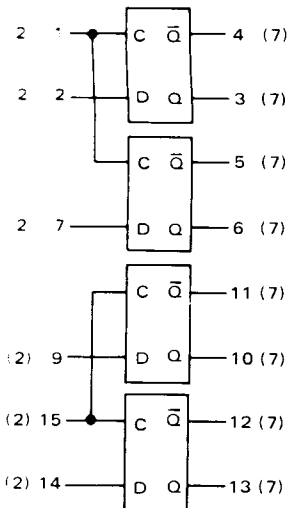

FUNCTIONAL LOGIC DIAGRAM

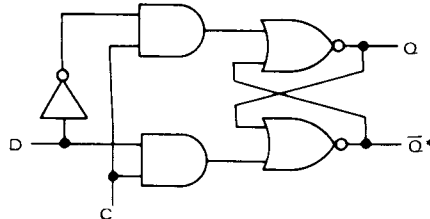

Information present at the Data Input D is transferred to the Q output when the clock is high, and the Q output will follow the state of the Data input as long as the clock remains high. Information present at the Q output will be retained as the clock goes low until such time as the clock is permitted to go high.

TRUTH TABLE

t_n	t_{n+1}	
	Q	\bar{Q}^*
1	1	0
0	0	1

*As applicable (see loading diagram)

**MC1814/MC1914
Quad Latch**

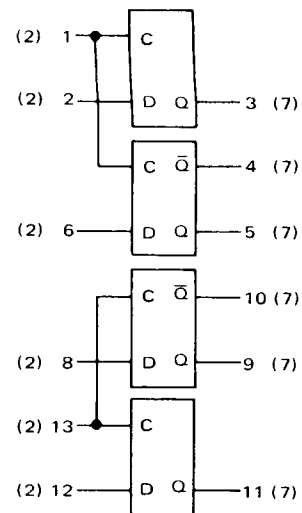

**MC1815/MC1915
MC1816/MC1916
Parallel Gated Clocked Flip-Flop**

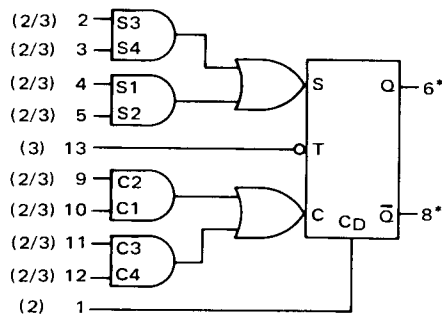

*Q and \bar{Q} loading factor
 12 - MC1815
 10 - MC1915
 11 - MC1816
 9 - MC1916

SYNCHRONOUS TRUTH TABLE

t_n									t_{n+1}
C_D	C3	C4	C1	C2	S3	S4	S1	S2	Q
1	0	0	0	0	0	0	0	0	Q_n
1	1	1	0	0	0	0	0	0	0
1	0	0	1	1	0	0	0	0	0
1	1	1	1	1	0	0	0	0	0
1	0	0	0	0	1	1	0	0	1
1	1	1	0	0	1	1	0	0	0
1	0	0	1	1	1	1	0	0	U
1	1	1	1	1	1	1	0	0	U
1	0	0	0	0	0	0	1	1	1
1	1	1	0	0	0	0	1	1	U
1	0	0	1	1	0	0	1	1	U
1	1	1	1	1	0	0	1	1	U
1	0	0	0	0	1	1	1	1	1
1	1	1	0	0	1	1	1	1	U
1	0	0	1	1	1	1	1	1	U
1	1	1	1	1	1	1	1	1	U

0 - Low State (more negative) NC - No Change
 1 - High State (more positive) U - Indeterminate State

J-K TRUTH TABLE

(Connect S2 and S4 to \bar{Q} , C2 and C4 to Q)

t_n				t_{n+1}
S1	S3	C1	C3	Q
0	0	0	0	Q_n
1	1	0	0	1
0	0	1	1	0
1	1	1	1	\bar{Q}_n

ASYNCHRONOUS TRUTH TABLE

C_D	Q	\bar{Q}
1	NC	NC
0	0	1

Asynchronous input, direct clear (C_D), overrides the synchronous inputs. Clocked operation will occur only when C_D is in the High State.

www.DataSheet4U.com
INVERTERS

**MC834/MC934
Hex Inverter**

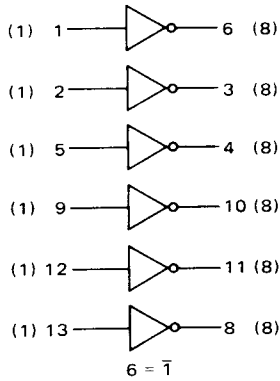

**MC835/MC935
Hex Inverter
(Without Output Resistors)**

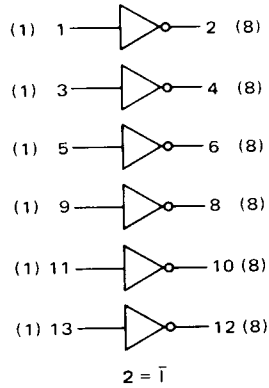

**MC836/MC936
MC837/MC937
Hex Inverter**

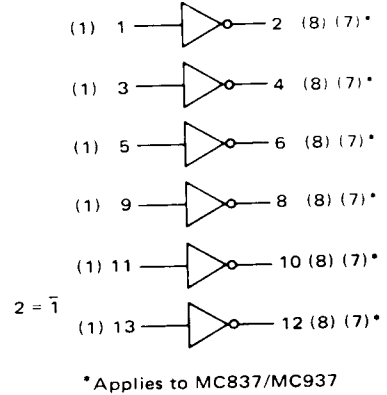

**MC840/MC940
Hex Inverter
(Without Input Diodes)**

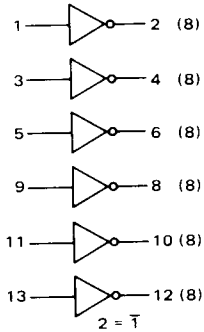

**MC841/MC941
Hex Inverter
(Without Output Resistors
and Input Diodes)**

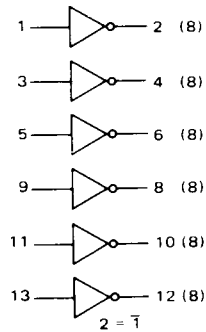

**MC846G/MC946G
MC849G/MC949G
Quad Inverter**

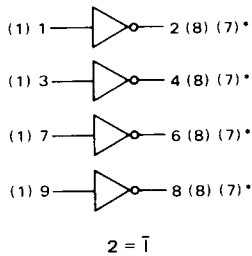

**MC1820
High Voltage
Hex Inverter
(Without Output Resistors)**

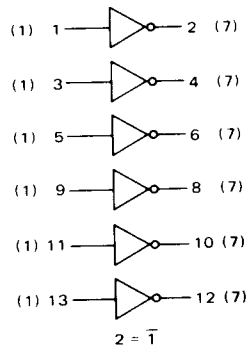

BUFFERS

**MC832/MC932
Expandable Dual 4-Input Buffer**

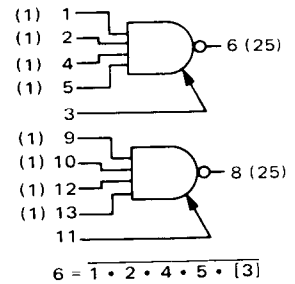

**MC832G/MC932G
Expandable Dual 3-2 Input Buffer**

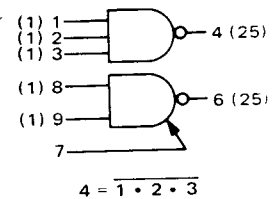

**MC857/MC957
Quad 2-Input Buffers**

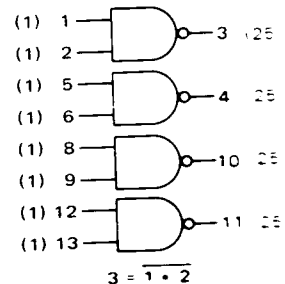

COUNTERS

MC838/MC938
Decade Counter

www.DataSheet4U.com

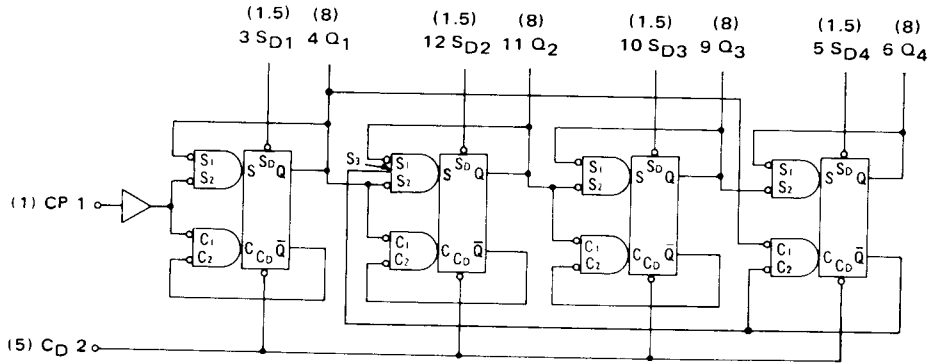

DECODING LOGIC

0	\bar{Q}_1	\bar{Q}_2	\bar{Q}_3	\bar{Q}_4
1	Q_1	\bar{Q}_2	\bar{Q}_3	\bar{Q}_4
2	\bar{Q}_1	Q_2	\bar{Q}_3	\bar{Q}_4
3	Q_1	Q_2	\bar{Q}_3	\bar{Q}_4
4	\bar{Q}_1	\bar{Q}_2	Q_3	\bar{Q}_4
5	Q_1	\bar{Q}_2	Q_3	\bar{Q}_4
6	\bar{Q}_1	Q_2	Q_3	\bar{Q}_4
7	Q_1	Q_2	Q_3	\bar{Q}_4
8	\bar{Q}_1			Q_4
9	Q_1			Q_4

MC839/MC939
Divide-by-Sixteen Counter

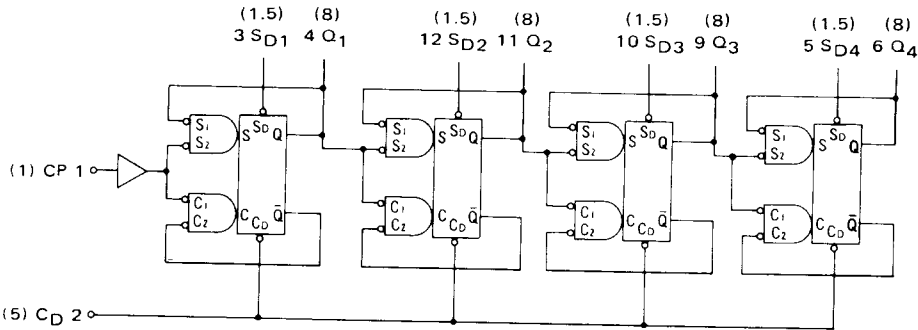

DECODING LOGIC

0	\bar{Q}_1	\bar{Q}_2	\bar{Q}_3	\bar{Q}_4
1	Q_1	\bar{Q}_2	\bar{Q}_3	\bar{Q}_4
2	\bar{Q}_1	Q_2	\bar{Q}_3	\bar{Q}_4
3	Q_1	Q_2	\bar{Q}_3	\bar{Q}_4
4	\bar{Q}_1	\bar{Q}_2	Q_3	\bar{Q}_4
5	Q_1	\bar{Q}_2	Q_3	\bar{Q}_4
6	\bar{Q}_1	Q_2	Q_3	\bar{Q}_4
7	Q_1	Q_2	Q_3	\bar{Q}_4
8	\bar{Q}_1	\bar{Q}_2	\bar{Q}_3	Q_4
9	Q_1	\bar{Q}_2	\bar{Q}_3	Q_4
10	\bar{Q}_1	Q_2	\bar{Q}_3	Q_4
11	Q_1	Q_2	\bar{Q}_3	Q_4
12	\bar{Q}_1	\bar{Q}_2	Q_3	Q_4
13	Q_1	\bar{Q}_2	Q_3	Q_4
14	\bar{Q}_1	Q_2	Q_3	Q_4
15	Q_1	Q_2	Q_3	Q_4

EXPANDERS

MC833/MC933
Dual 4-Input Expander

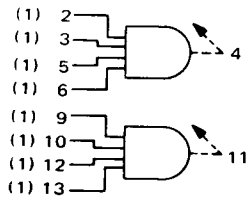

MC833G/MC933G
Dual 4-3 Input Expander

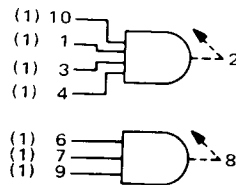

MC847/MC947
Quad 2-Input Gate Expander

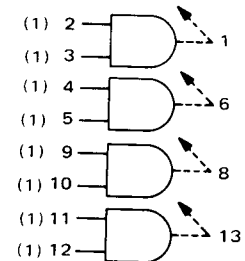

PULSE TRIGGERED BINARY

MC850/MC950 Pulse Triggered Binary

www.DataSheet4U.com

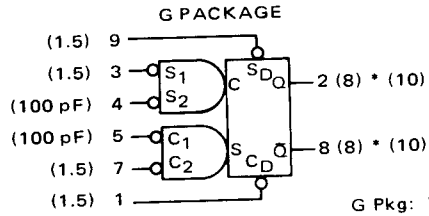
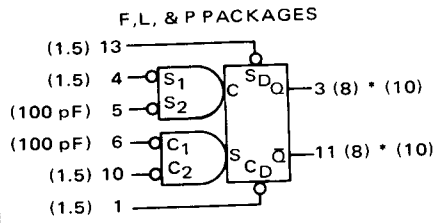

G Pkg: V_{CC} = Pin 10, Gnd = Pin 6

* Applies to MC950

SYNCHRONOUS TRUTH TABLE

t_n				t_{n+1}
S_1	S_2	C_1	C_2	Q
0	0	0	0	U
1	X	1	X	Q_n
X	1	X	1	Q_n
0	1	1	0	Q_n
0	0	X	1	1
0	0	1	X	1
1	X	0	0	0
X	1	0	0	0

ASYNCHRONOUS TRUTH TABLE

S_D	C_D	Q	\bar{Q}
1	1	NC	NC
0	1	1	0
1	0	0	1
0	0	1	1

0 = low state (more negative)
1 = high state (more positive)
X = don't care
U = indeterminate state
NC = no change

SINGLE TRIGGER TRUTH TABLE (Pins S_2 and C_1 tied together)

t_n		t_{n+1}
S_1	C_2	Q
0	0	U
1	0	0
0	1	1
1	1	Q_n