

# MC3242A



## MEMORY ADDRESS MULTIPLEXER FOR 16K RAMS

The Motorola MC3242A is an address multiplexer and refresh counter for 16-pin 16K dynamic RAMs that require a 128-cycle refresh. It multiplexes fourteen system address bits to the seven address pins of the memory device. The MC3242A also contains a 7-bit refresh counter that is clocked externally to generate the 128 sequential addresses required for refresh. The high performance of the MC3242A will enhance the high speed of the N-channel RAMs such as the MCM4116.

- Simplifies 16-Pin 16K Dynamic Memory Design
- Reduces Package Count
- 7-Bit Binary Counter for 128 Refresh Address
- Multiplexing: Row Address/Column Address/Refresh Address
- High Input Impedance for Minimum Loading of Bus:
  - $I_F = 0.25 \text{ mA Max}$
- Schottky TTL for High Performance Address Input to Output Delay –
  - $t_{AO} = 25 \text{ ns @ } C_L = 250 \text{ pF}$
- Second Source to Intel 3242  
(Detect Zero Function Not Included and Additional Chip Enable Feature Added at Pin 15)

7

## MEMORY ADDRESS MULTIPLEXER AND REFRESH ADDRESS COUNTER

SCHOTTKY SILICON MONOLITHIC INTEGRATED CIRCUITS

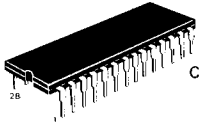

L SUFFIX CERAMIC PACKAGE CASE 733-03

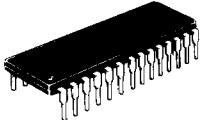

P SUFFIX PLASTIC PACKAGE CASE 710-02

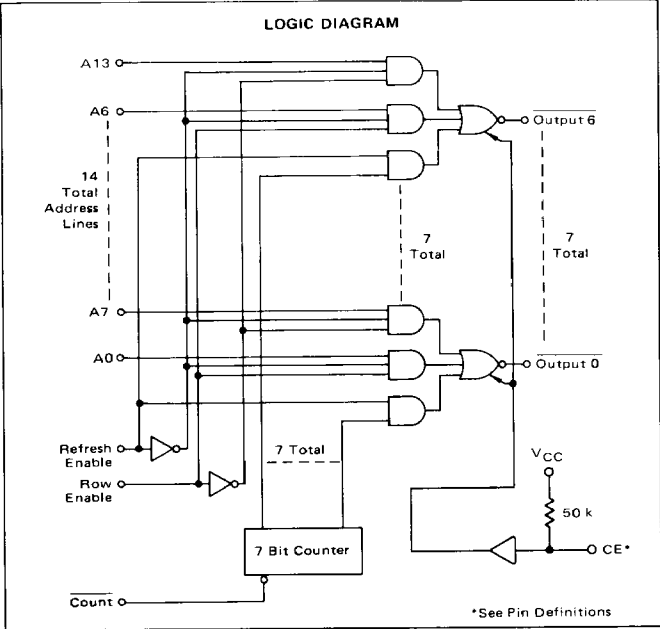

Count	1	28	VCC
Ref En	2	27	A6
Row En	3	26	A13
N.C.	4	25	A5
A1	5	24	A12
A8	6	23	A4
A2	7	22	A11
A9	8	21	A3
A0	9	20	A10
A7	10	19	O6
O0	11	18	O3
O2	12	17	O4
O1	13	16	O5
Gnd	14	15	CE*

Note: A0 Through A6 Are Row Addresses  
A7 Through A13 Are Column Addresses  
\*See Pin Definitions

### TRUTH TABLE AND DEFINITIONS

Refresh Enable	Row Enable	Output
H	X	Refresh Address (From Internal Counter)
L	H	Row Address (A0 through A6)
L	L	Column Address (A7 through A13)

Count – Advances Internal Refresh Counter

### ORDERING INFORMATION

Device	Temperature Range	Package
MC3242AL	0 to 75°C	Ceramic DIP
MC3242AP	0 to 75°C	Plastic DIP

**ABSOLUTE MAXIMUM RATINGS** ( $T_A = 25^\circ\text{C}$  unless otherwise noted.)

Rating	Symbol	Value	Unit
Power Supply Voltage	$V_{CC}$	-0.5 to +7.0	V
Input Voltage	$V_I$	-0.5 to +7.0	V
Output Voltage	$V_O$	-0.5 to +7.0	V
Output Current	$I_O$	100	mA
Operating Ambient Temperature	$T_A$	0 to +75	$^\circ\text{C}$
Storage Temperature	$T_{stg}$	-65 to +150	$^\circ\text{C}$
Junction Temperature	$T_J$	+175	$^\circ\text{C}$
Ceramic Package		+150	
Plastic Package			

"Absolute Maximum Ratings" are those values beyond which the safety of the device cannot be guaranteed. This is a stress rating only and functional operation of the device at these or any other conditions above those indicated in the operational sections of this specification is not implied. Exposure to absolute maximum ratings for extended periods may affect reliability.

**ELECTRICAL CHARACTERISTICS** (Unless otherwise noted, Min/Max values apply with  $4.5\text{ V} \leq V_{CC} \leq 5.5\text{ V}$ ,  $0^\circ\text{C} \leq T_A \leq 75^\circ\text{C}$ ; typical values apply with  $V_{CC} = 5.0\text{ V}$ ,  $T_A = 25^\circ\text{C}$ .)

Characteristic	Symbol	Min	Typ	Max	Unit
Input Current, Low Logic State ( $V_{IL} = 0.45\text{ V}$ )	$I_{IL}$	—	-0.25	-0.40	mA
Input Current, High Logic State ( $V_{IH} = 5.5\text{ V}$ )	$I_{IH}$	—	—	10	$\mu\text{A}$
Input Voltage, Low Logic State	$V_{IL}$	—	—	0.8	V
Input Voltage, High Logic State	$V_{IH}$	2.0	—	—	V
Output Voltage, Low Logic State ( $I_{OL} = 5.0\text{ mA}$ )	$V_{OL}$	—	0.25	0.4	V
Output Voltage, High Logic State ( $I_{OH} = -1.0\text{ mA}$ )	$V_{OH}$	3.0	4.0	—	V
Input Clamp Voltage ( $I_{IK} = -12\text{ mA}$ )	$V_{IK}$	—	-0.8	-1.5	V
Power Supply Current ( $V_{CC} = 5.5\text{ V}$ )	$I_{CC}$	—	80	125	mA

**SWITCHING CHARACTERISTICS** (Unless otherwise noted, Min/Max values apply with  $4.5\text{ V} \leq V_{CC} \leq 5.5\text{ V}$ ,  $0^\circ\text{C} \leq T_A \leq 75^\circ\text{C}$ ; typical values apply with  $V_{CC} = 5.0\text{ V}$ ,  $T_A = 25^\circ\text{C}$ .)

Characteristic	Symbol	Min	Typ	Max	Unit
Propagation Delay Times					
Address Input to Output (Load = 1 TTL, $C_L = 250\text{ pF}$ ) (Load = 1 TTL, $C_L = 15\text{ pF}$ , $V_{CC} = 5.0\text{ V}$ , $T_A = 25^\circ\text{C}$ )	$t_{AO}$	—	12 6.0	25 9.0	ns
Row Enable to Output (Load = 1 TTL, $C_L = 250\text{ pF}$ ) (Load = 1 TTL, $C_L = 15\text{ pF}$ , $V_{CC} = 5.0\text{ V}$ , $T_A = 25^\circ\text{C}$ )	$t_{OO}$	12 7	27 12	41 27	ns
Refresh Enable to Output (Load = 1 TTL, $C_L = 250\text{ pF}$ ) (Load = 1 TTL, $C_L = 15\text{ pF}$ , $V_{CC} = 5.0\text{ V}$ , $T_A = 25^\circ\text{C}$ )	$t_{EO}$	12 7	30 14	45 27	ns
Count Pulse Width	$t_{WC}$	30	—	—	ns
Counting Frequency	$f_C$	5.0	10	—	MHz

FIGURE 1 - AC WAVEFORMS WITH MCM4116 NORMAL CYCLE

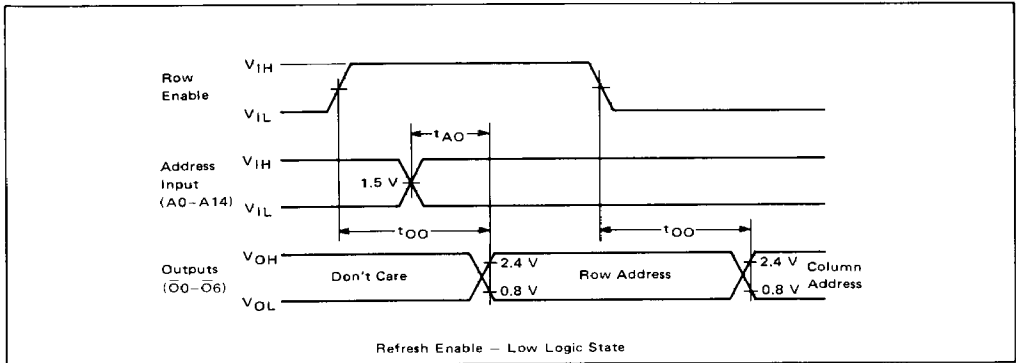
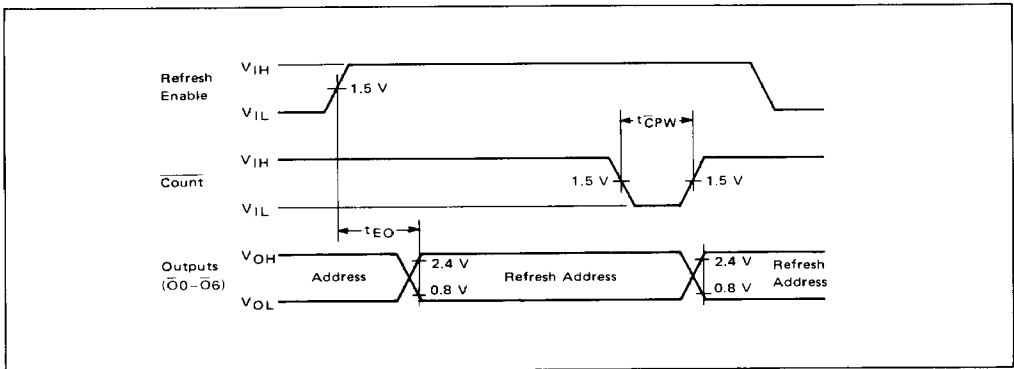

FIGURE 2 - REFRESH CYCLE



7

TYPICAL CHARACTERISTICS

FIGURE 3 - OUTPUT CURRENT versus OUTPUT LOW VOLTAGE

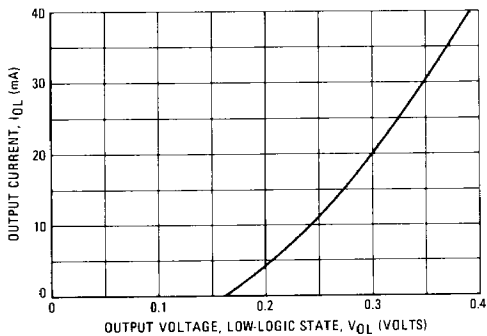
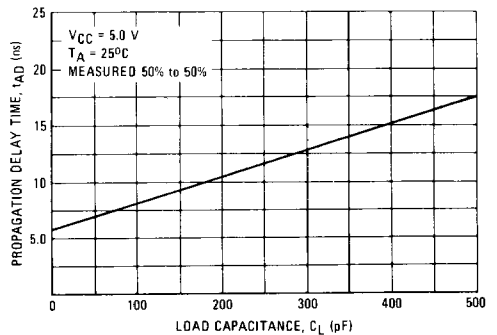

FIGURE 4 - PROPAGATION DELAY versus LOAD CAPACITANCE Row or Column Address to Output



PIN DEFINITIONS

**Count Input – Pin 1**

Active low input increments internal 6-bit counter by one for each count pulse in.

**Refresh Enable Input – Pin 2**

Active high input which determines whether the MC3242A is in refresh mode (H) or address enable (L).

**A0–A6 Inputs – Pins 9, 5, 7, 21, 23, 27**

Row address inputs.

**A7–A13 Inputs – Pins 10, 6, 8, 20, 22, 24, 26**

Column address inputs.

**$\overline{O0}$ – $\overline{O6}$  Outputs – Pins 11, 12, 13, 18, 17, 16, 19**

Address outputs to memories. Inverted with respect to address inputs.

**Gnd – Pin 14**

Power supply ground.

**CE Input – Pin 15**

Optional use, chip enable control pin. Left open, an internal 50 k $\Omega$  pullup resistor keeps this pin high and the MC3242A is a functional replacement for the Intel 3242 (without detect zero function). As an active input, when pulled low, all 3242A outputs go three-state.

**V<sub>CC</sub> – Pin 28**

+5 V power supply input. Due to high capacitance drive capability, a 0.1  $\mu$ F capacitor should be used to ground along with careful V<sub>CC</sub> and Gnd Bus layout.

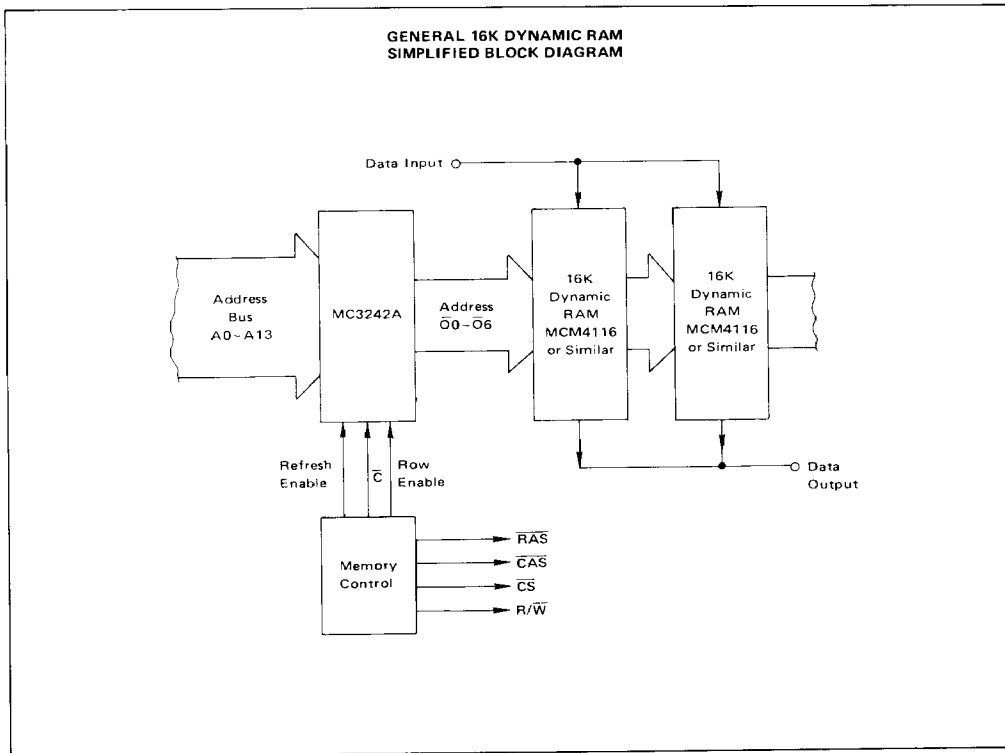

TYPICAL APPLICATION  
16K X 8-BIT MEMORY SYSTEM FOR M6800

Note: Numbers in parenthesis indicate part types or values for 16K x 1 RAMs

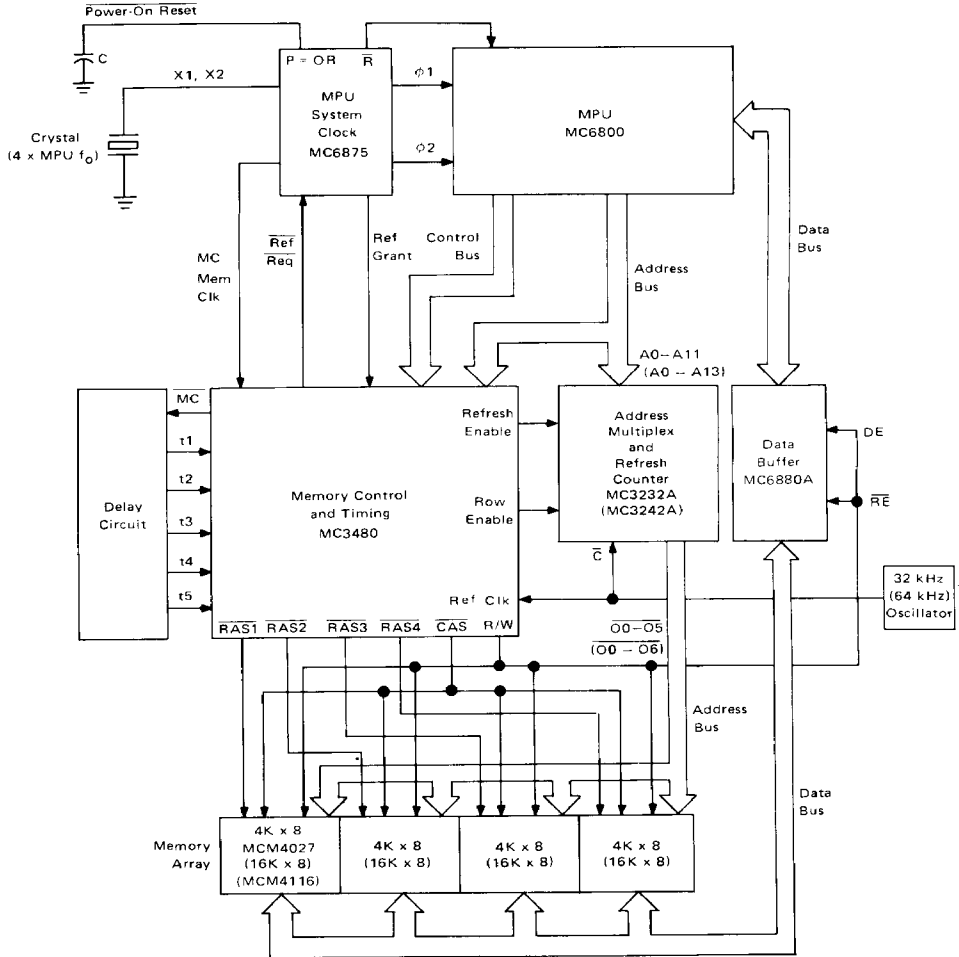

7