

MC33076

Dual High Output Current, Low Power, Low Noise Bipolar Operational Amplifier

The MC33076 operational amplifier employs bipolar technology with innovative high performance concepts for audio and industrial applications. This device uses high frequency PNP input transistors to improve frequency response. In addition, the amplifier provides high output current drive capability while minimizing the drain current. The all NPN output stage exhibits no deadband crossover distortion, large output voltage swing, excellent phase and gain margins, low open loop high frequency output impedance and symmetrical source and sink AC frequency performance.

The MC33076 is tested over the automotive temperature range and is available in an 8-pin SOIC package (D suffix) and in the standard 8 pin DIP package for high power applications.

- 100 Ω Output Drive Capability
- Large Output Voltage Swing
- Low Total Harmonic Distortion
- High Gain Bandwidth: 7.4 MHz
- High Slew Rate: 2.6 V/ μ s
- Dual Supply Operation: ± 2.0 V to ± 18 V
- High Output Current: ISC = 250 mA typ
- Similar Performance to MC33178

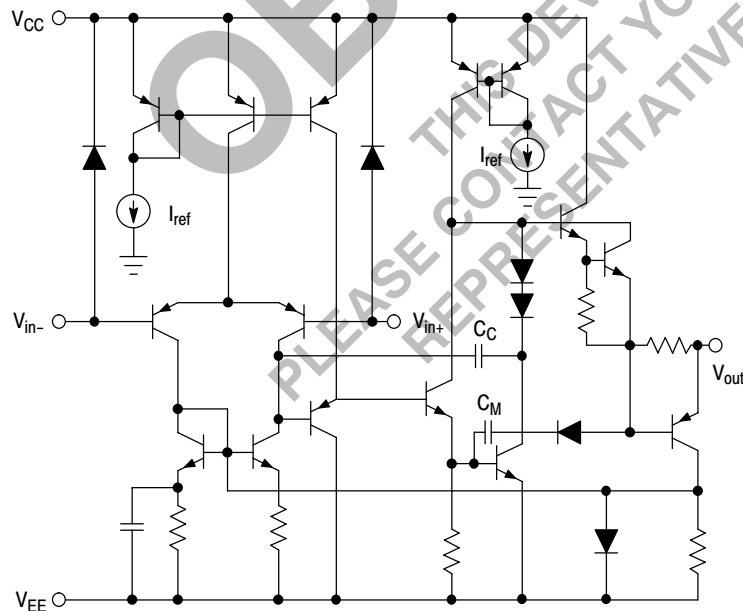

Figure 1. Equivalent Circuit Schematic (Each Amplifier)



ON Semiconductor™

<http://onsemi.com>

MARKING DIAGRAMS

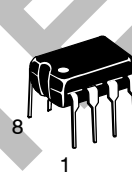

PDIP-8
P1 SUFFIX
CASE 626

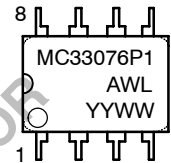

SO-8
D SUFFIX
CASE 751

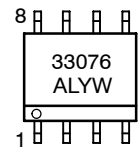

A = Assembly Location
WL, L = Wafer Lot
YY, Y = Year
WW, W = Work Week

PIN CONNECTIONS

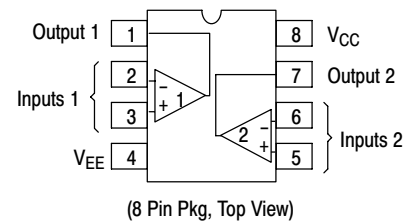

ORDERING INFORMATION

Device	Package	Shipping
MC33076D	SO-8	98 Units/Rail
MC33076DR2	SO-8	2500 Tape & Reel
MC33076P1	PDIP-8	50 Units/Rail

MAXIMUM RATINGS

Rating	Symbol	Value	Unit
Power Supply Voltage (Note 2)	V_{CC} to V_{EE}	+36	V
Input Differential Voltage Range	V_{IDR}	Note 1	V
Input Voltage Range	V_{IR}	Note 1	V
Output Short Circuit Duration (Note 2)	t_{SC}	5.0	sec
Maximum Junction Temperature	T_J	+150	°C
Storage Temperature	T_{stg}	-60 to +150	°C
Maximum Power Dissipation	P_D	Note 2	mW

- Either or both input voltages should not exceed V_{CC} or V_{EE} .
- Power dissipation must be considered to ensure maximum junction temperature (T_J) is not exceeded** (see power dissipation performance characteristic, Figure 2). See applications section for further information.

DC ELECTRICAL CHARACTERISTICS ($V_{CC} = +15$ V, $V_{EE} = -15$ V, $T_A = 25^\circ\text{C}$, unless otherwise noted.)

Characteristics	Figure	Symbol	Min	Typ	Max	Unit
Input Offset Voltage ($R_S = 50 \Omega$, $V_{CM} = 0$ V) ($V_S = \pm 2.5$ V to ± 15 V) $T_A = +25^\circ\text{C}$ $T_A = -40^\circ$ to $+85^\circ\text{C}$	3	$ V_{IO} $	\square \square - -	\square \square 0.5 0.5	\square \square 4.0 5.0	mV
Input Offset Voltage Temperature Coefficient ($R_S = 50 \Omega$, $V_{CM} = 0$ V) $T_A = -40^\circ$ to $+85^\circ\text{C}$		$\Delta V_{IO}/\Delta T$	-	2.0	-	$\mu\text{V}/^\circ\text{C}$
Input Bias Current ($V_{CM} = 0$ V) $T_A = +25^\circ\text{C}$ $T_A = -40^\circ$ to $+85^\circ\text{C}$	4, 5	I_{IB}	- -	100 -	500 600	nA
Input Offset Current ($V_{CM} = 0$ V) $T_A = +25^\circ\text{C}$ $T_A = -40^\circ$ to $+85^\circ\text{C}$		$ I_{IO} $	- -	5.0 -	70 100	nA
Common Mode Input Voltage Range	6	V_{ICR}	-13	-14 +14	13	V
Large Signal Voltage Gain ($V_O = -10$ V to $+10$ V) ($T_A = +25^\circ\text{C}$) $R_L = 100 \Omega$ $R_L = 600 \Omega$ ($T_A = -40^\circ$ to $+85^\circ\text{C}$) $R_L = 600 \Omega$	7	A_{VOL}	25 50 25	- 200 -	- - -	kV/V
Output Voltage Swing ($V_{ID} = \pm 1.0$ V) ($V_{CC} = +15$ V, $V_{EE} = -15$ V) $R_L = 100 \Omega$ $R_L = 100 \Omega$ $R_L = 600 \Omega$ $R_L = 600 \Omega$ ($V_{CC} = +2.5$ V, $V_{EE} = -2.5$ V) $R_L = 100 \Omega$ $R_L = 100 \Omega$	8, 9, 10	V_{O+} V_{O-} V_{O+} V_{O-} V_{O+} V_{O-}	10 - 13 - 1.2 -	+11.7 -11.7 +13.8 -13.8 +1.66 -1.74	- -10 - -13 - -1.2	V
Common Mode Rejection ($V_{in} = \pm 13$ V)	11	CMR	80	116	-	dB
Power Supply Rejection ($V_{CC}/V_{EE} = +15$ V/ -15 V, $+5.0$ V/ -15 V, $+15$ V/ -5.0 V)	12	PSR	80	120	-	dB

MC33076

DC ELECTRICAL CHARACTERISTICS ($V_{CC} = +15\text{ V}$, $V_{EE} = -15\text{ V}$, $T_A = 25^\circ\text{C}$, unless otherwise noted.)

Characteristics	Figure	Symbol	Min	Typ	Max	Unit
Output Short Circuit Current ($V_{ID} = \pm 1.0\text{ V}$ Output to Gnd) ($V_{CC} = +15\text{ V}$, $V_{EE} = -15\text{ V}$) Source Sink ($V_{CC} = +2.5\text{ V}$, $V_{EE} = -2.5\text{ V}$) Source Sink	13, 14	I_{SC}	190 -	+250 -280	- -215	mA
Power Supply Current per Amplifier ($V_O = 0\text{ V}$) ($V_S = \pm 2.5\text{ V}$ to $\pm 15\text{ V}$) $T_A = +25^\circ\text{C}$ $T_A = -40^\circ$ to $+85^\circ\text{C}$	15	I_D	- -	2.2 -	2.8 3.3	mA

AC ELECTRICAL CHARACTERISTICS ($V_{CC} = +15\text{ V}$, $V_{EE} = -15\text{ V}$, $T_A = 25^\circ\text{C}$, unless otherwise noted.)

Characteristics	Figure	Symbol	Min	Typ	Max	Unit
Slew Rate ($V_{in} = -10\text{ V}$ to $+10\text{ V}$, $R_L = 100\ \Omega$, $C_L = 100\text{ pF}$, $A_V = 1.0$)	16	SR	1.2	2.6	-	V/ μs
Gain Bandwidth Product ($f = 20\text{ kHz}$)	17	GBW	4.0	7.4	-	MHz
Unity Gain Bandwidth (Open Loop) ($R_L = 600\ \Omega$, $C_L = 0\text{ pF}$)	-	BW	-	3.5	-	MHz
Gain Margin ($R_L = 600\ \Omega$, $C_L = 0\text{ pF}$)	20, 21	A_m	-	15	-	dB
Phase Margin ($R_L = 600\ \Omega$, $C_L = 0\text{ pF}$)	20, 21	ϕ_m	-	52	-	Deg
Channel Separation ($f = 100\text{ Hz}$ to 20 kHz)	22	CS	-	-120	-	dB
Power Bandwidth ($V_O = 20\text{ V}_{pp}$, $R_L = 600\ \Omega$, $\text{THD} \leq 1\%$)	-	BW_p	-	32	-	kHz
Total Harmonic Distortion ($R_L = 600\ \Omega$, $V_O = 2.0\text{ V}_{pp}$, $A_V = 1.0$) $f = 1.0\text{ kHz}$ $f = 10\text{ kHz}$ $f = 20\text{ kHz}$	23	THD	-	0.0027 0.011 0.022	-	%
Open Loop Output Impedance ($V_O = 0\text{ V}$, $f = 2.5\text{ MHz}$, $A_V = 10$)	24	$ Z_O $	-	75	-	Ω
Differential Input Resistance ($V_{CM} = 0\text{ V}$)	-	R_{in}	-	200	-	k Ω
Differential Input Capacitance ($V_{CM} = 0\text{ V}$)	-	C_{in}	-	10	-	pF
Equivalent Input Noise Voltage ($R_S = 100\ \Omega$) $f = 10\text{ Hz}$ $f = 1.0\text{ kHz}$	25	e_n	-	7.5 5.0	-	nV/ $\sqrt{\text{Hz}}$
Equivalent Input Noise Current $f = 10\text{ Hz}$ $f = 1.0\text{ kHz}$	-	i_n	-	0.33 0.15	-	pA/ $\sqrt{\text{Hz}}$

MC33076

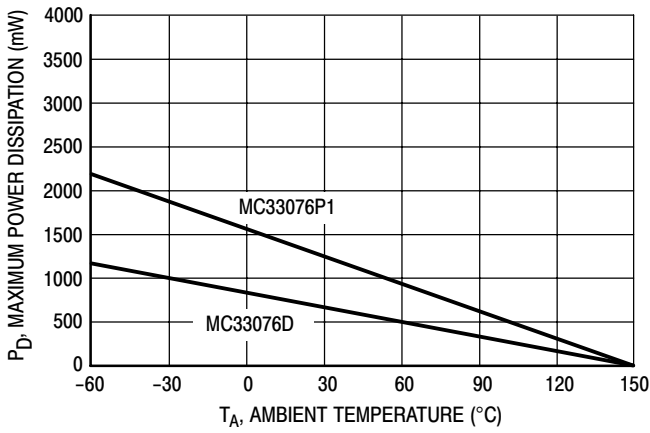

Figure 2. Maximum Power Dissipation versus Temperature

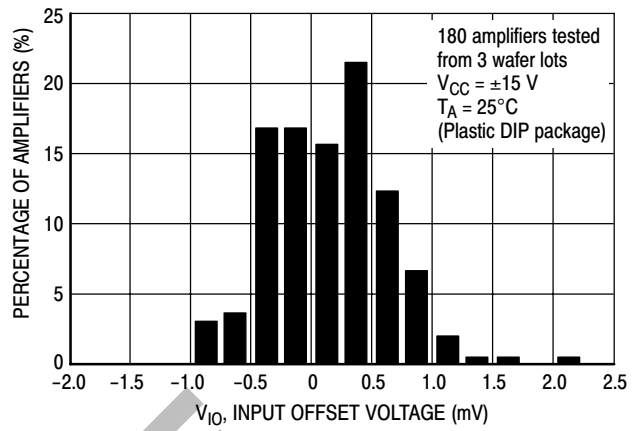

Figure 3. Distribution of Input Offset Voltage

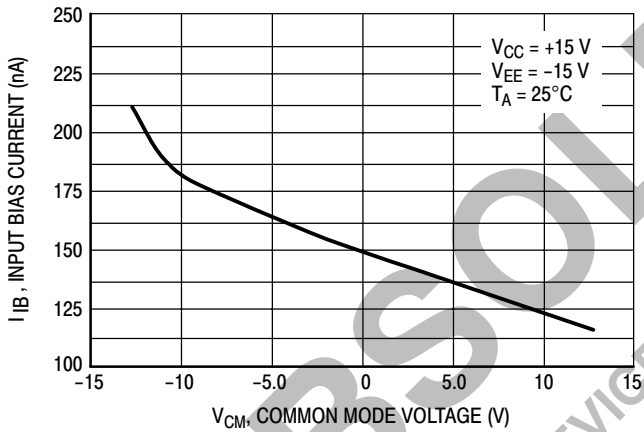

Figure 4. Input Bias Current versus Common Mode Voltage

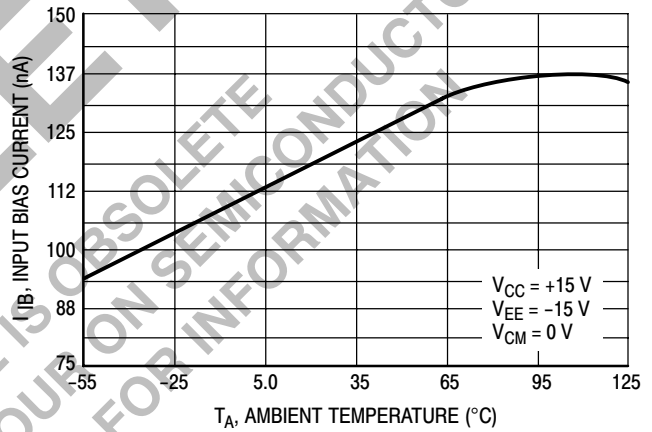

Figure 5. Input Bias Current versus Temperature

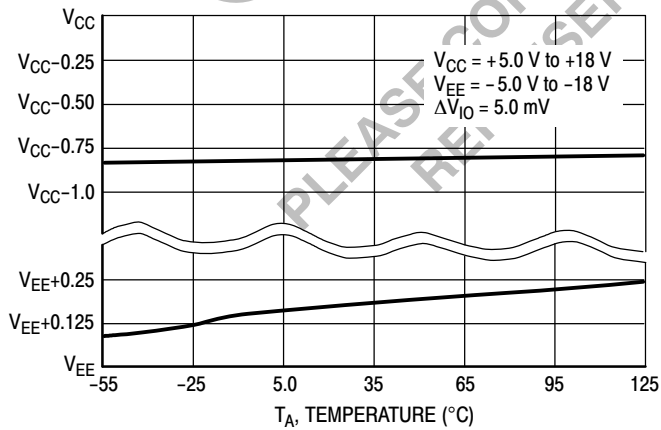

Figure 6. Input Common Mode Voltage Range versus Temperature

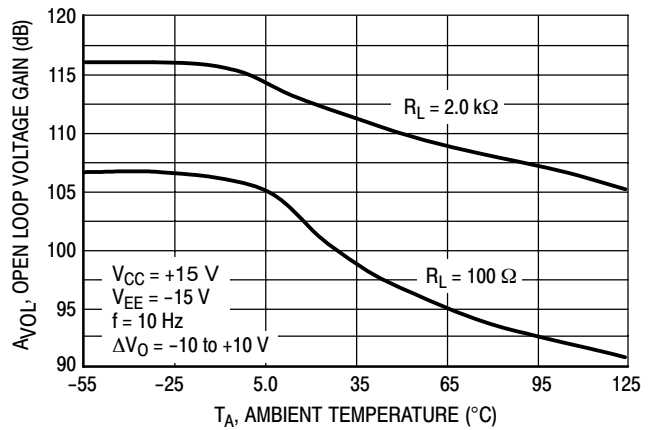

Figure 7. Open Loop Voltage Gain versus Temperature

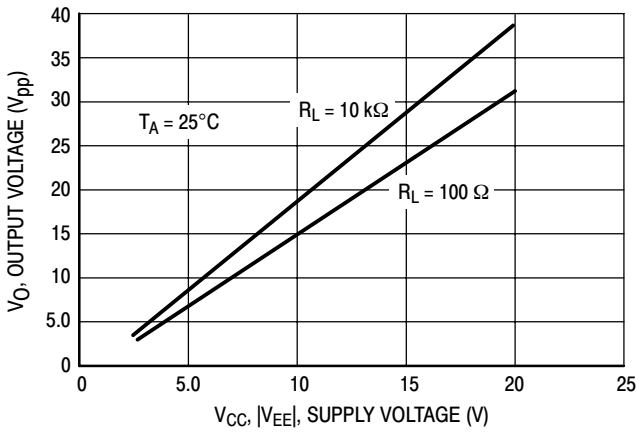

Figure 8. Output Voltage Swing versus Supply Voltage

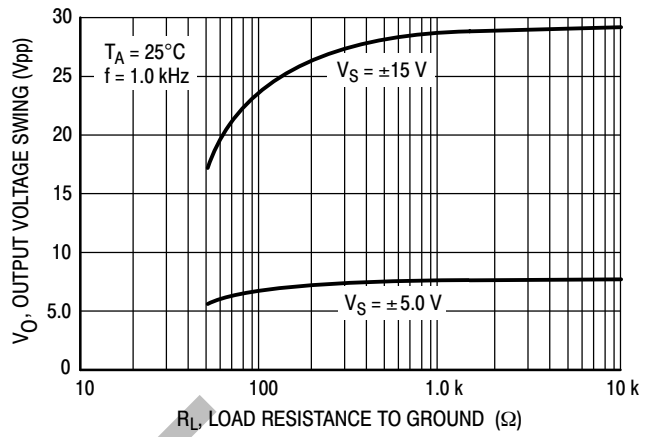

Figure 9. Maximum Peak-to-Peak Output Voltage Swing versus Load Resistance

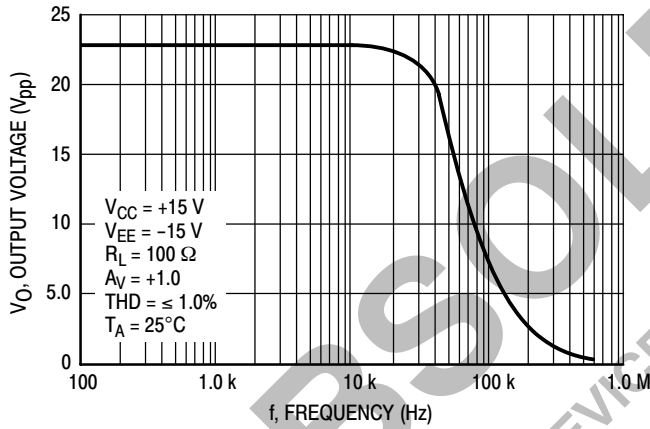

Figure 10. Output Voltage versus Frequency

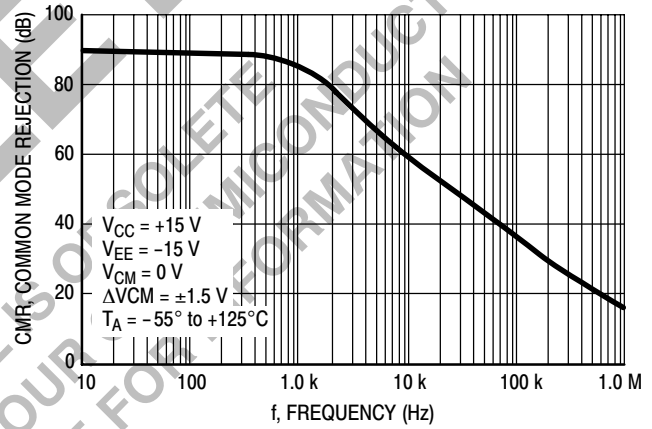

Figure 11. Common Mode Rejection versus Frequency Over Temperature

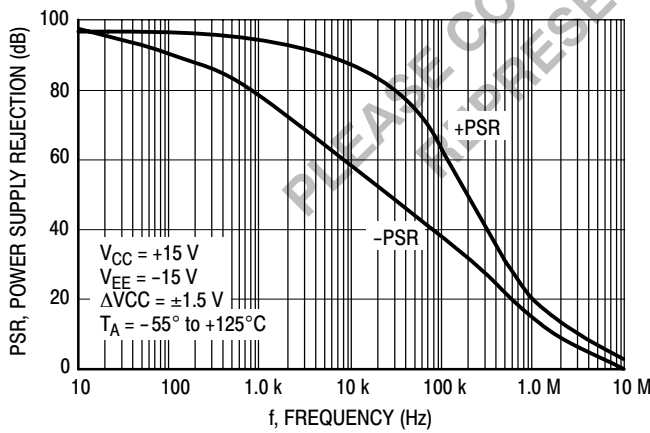

Figure 12. Power Supply Rejection versus Frequency Over Temperature

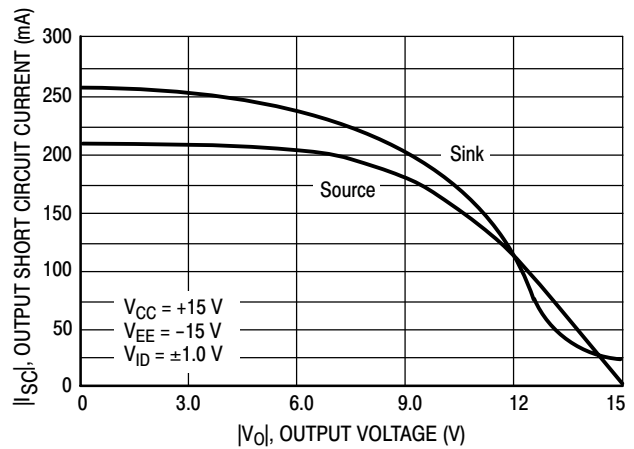

Figure 13. Output Short Circuit Current versus Output Voltage

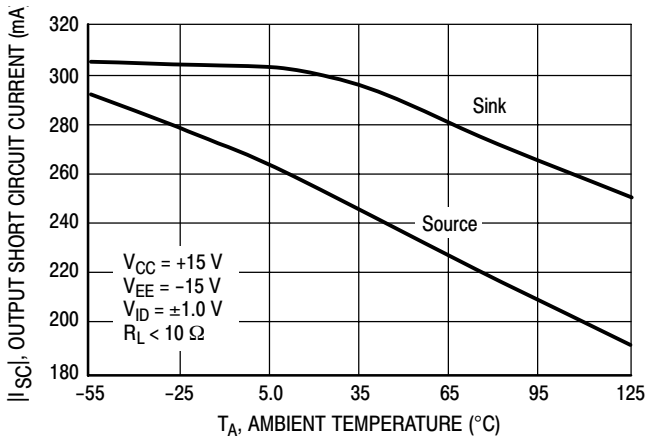

Figure 14. Output Short Circuit Current versus Temperature

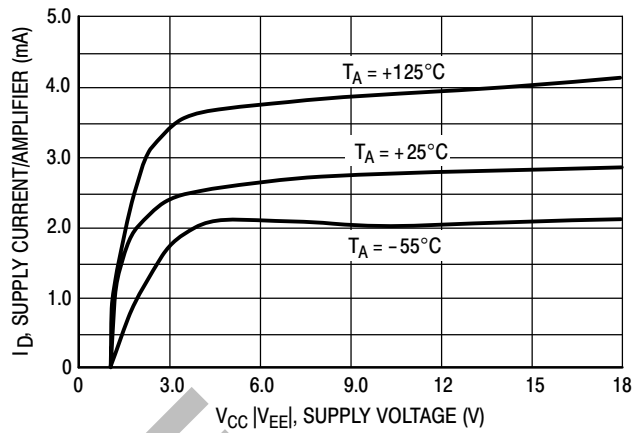

Figure 15. Supply Current versus Supply Voltage with No Load

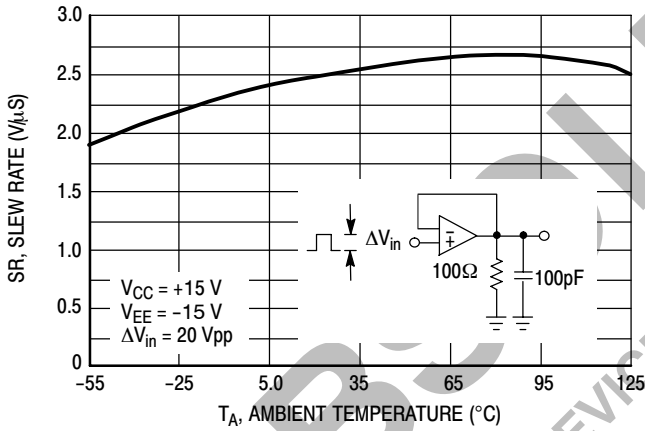

Figure 16. Slew Rate versus Temperature

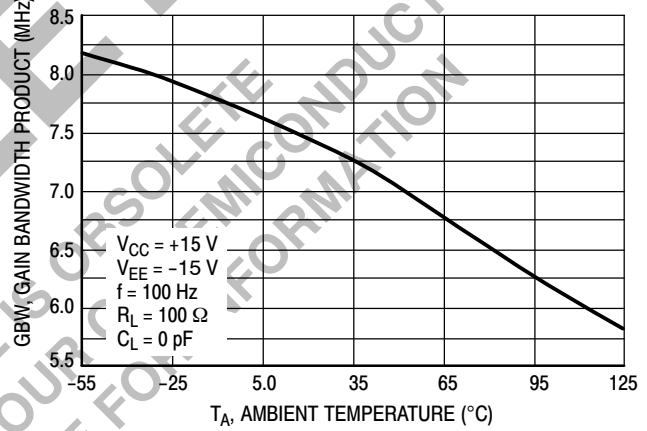

Figure 17. Gain Bandwidth Product versus Temperature

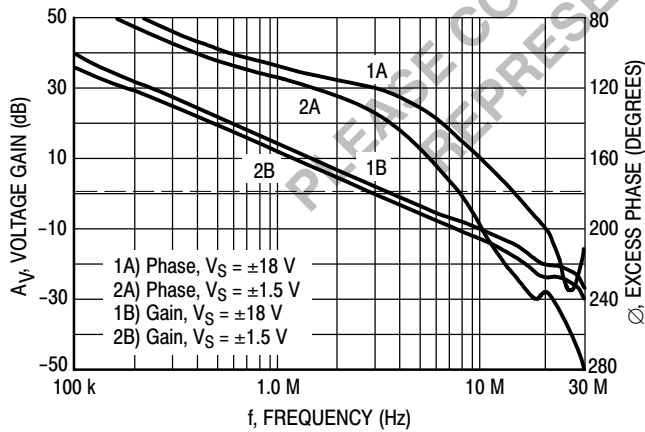

Figure 18. Voltage Gain and Phase versus Frequency

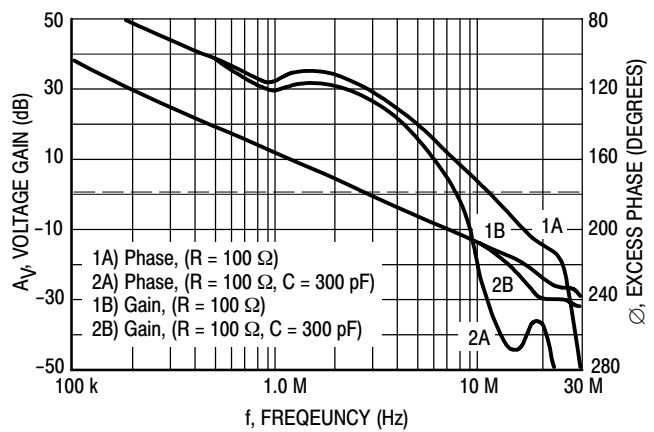

Figure 19. Voltage Gain and Phase versus Frequency

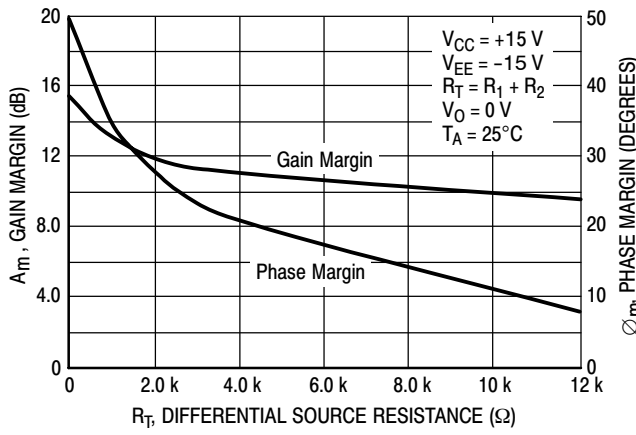

Figure 20. Phase Margin and Gain Margin versus Differential Source Resistance

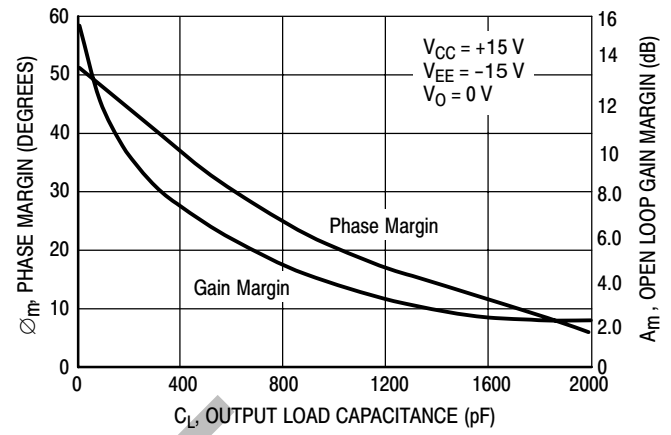

Figure 21. Open Loop Gain Margin and Phase Margin versus Output Load Capacitance

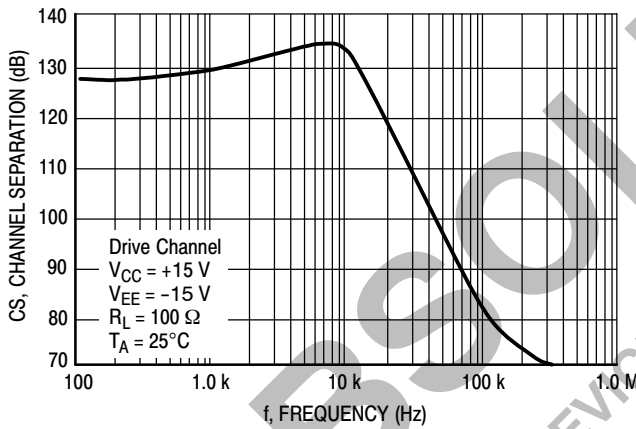

Figure 22. Channel Separation versus Frequency

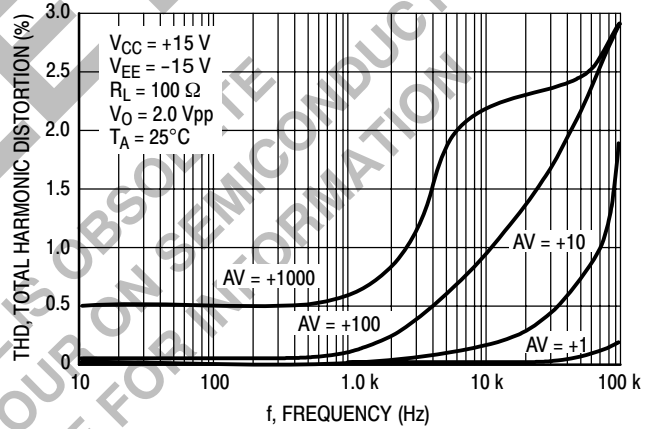

Figure 23. Total Harmonic Distortion versus Frequency

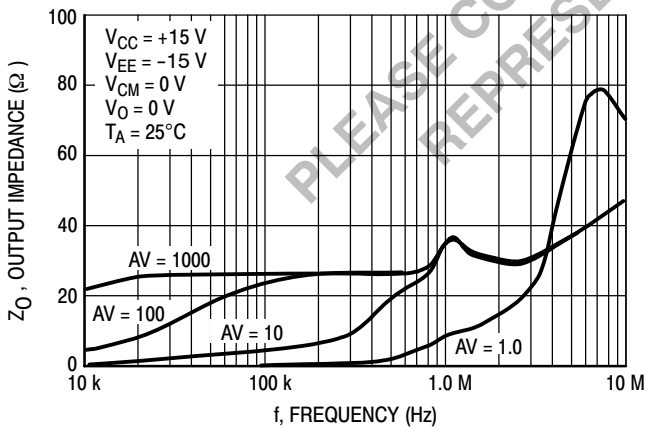

Figure 24. Output Impedance versus Frequency

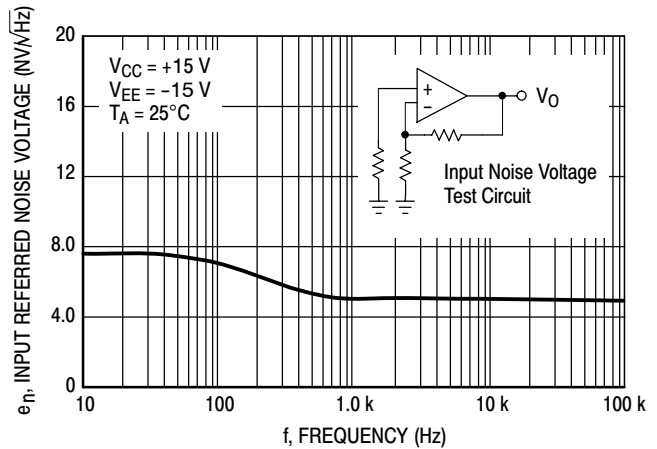

Figure 25. Input Referred Noise Voltage versus Frequency

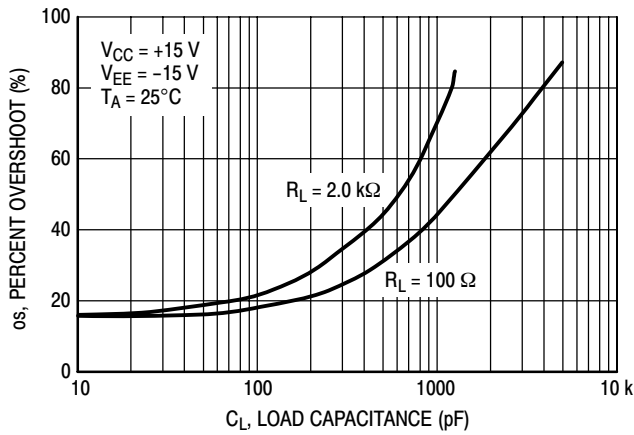

Figure 26. Percent Overshoot versus Load Capacitance

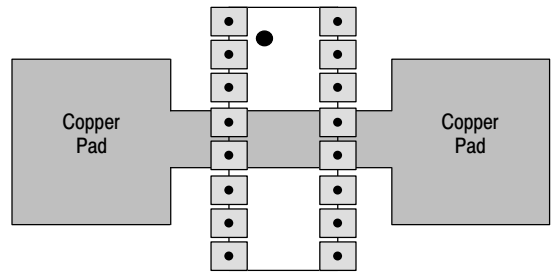

Figure 27. PC Board Heatsink Example

APPLICATIONS INFORMATION

The MC33076 dual operational amplifier is available in the standard 8-pin plastic dual-in-line (DIP) and surface mount packages, and also in a 16-pin batwing power package. To enhance the power dissipation capability of the power package, Pins 4, 5, 12, and 13 are tied together on the leadframe, giving it an ambient thermal resistance of

52°C/W typically, in still air. The junction-to-ambient thermal resistance ($R_{\theta JA}$) can be decreased further by using a copper pad on the printed circuit board (as shown in Figure 27) to draw the heat away from the package. *Care must be taken not to exceed the maximum junction temperature or damage to the device may occur.*

OBSOLETE

THIS DEVICE IS OBSOLETE
PLEASE CONTACT YOUR ONSEMI REPRESENTATIVE FOR INFORMATION

MC33076

PACKAGE DIMENSIONS

PDIP-8
P1 SUFFIX
CASE 626-05
ISSUE L

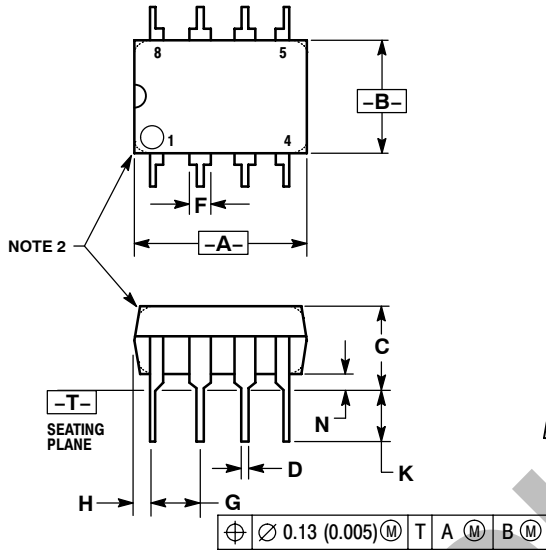

- NOTES:
1. DIMENSION L TO CENTER OF LEAD WHEN FORMED PARALLEL.
 2. PACKAGE CONTOUR OPTIONAL (ROUND OR SQUARE CORNERS).
 3. DIMENSIONING AND TOLERANCING PER ANSI Y14.5M, 1982.

DIM	MILLIMETERS		INCHES	
	MIN	MAX	MIN	MAX
A	9.40	10.16	0.370	0.400
B	6.10	6.60	0.240	0.260
C	3.94	4.45	0.155	0.175
D	0.38	0.51	0.015	0.020
F	1.02	1.78	0.040	0.070
G	2.54 BSC		0.100 BSC	
H	0.76	1.27	0.030	0.050
J	0.20	0.30	0.008	0.012
K	2.92	3.43	0.115	0.135
L	7.62 BSC		0.300 BSC	
M	---	10°	---	10°
N	0.76	1.01	0.030	0.040

SO-8
D SUFFIX
CASE 751-07
ISSUE W

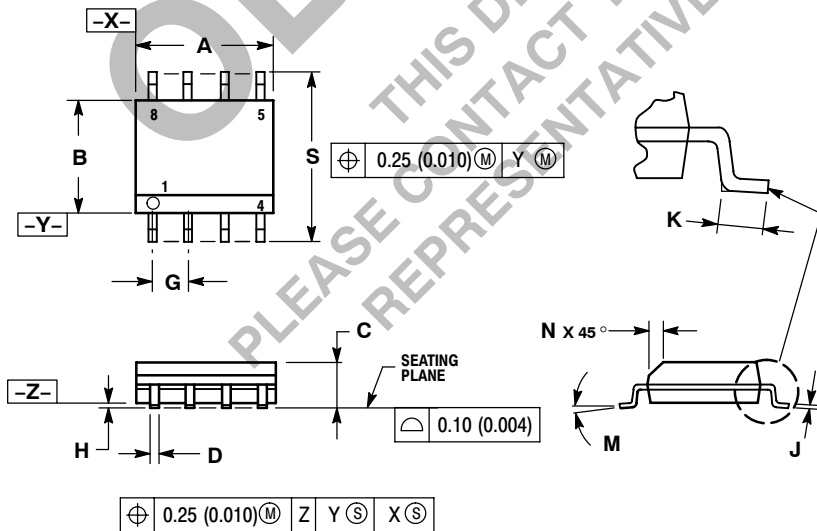

- NOTES:
1. DIMENSIONING AND TOLERANCING PER ANSI Y14.5M, 1982.
 2. CONTROLLING DIMENSION: MILLIMETER.
 3. DIMENSION A AND B DO NOT INCLUDE MOLD PROTRUSION.
 4. MAXIMUM MOLD PROTRUSION 0.15 (0.006) PER SIDE.
 5. DIMENSION D DOES NOT INCLUDE DAMBAR PROTRUSION. ALLOWABLE DAMBAR PROTRUSION SHALL BE 0.127 (0.005) TOTAL IN EXCESS OF THE D DIMENSION AT MAXIMUM MATERIAL CONDITION.

DIM	MILLIMETERS		INCHES	
	MIN	MAX	MIN	MAX
A	4.80	5.00	0.189	0.197
B	3.80	4.00	0.150	0.157
C	1.35	1.75	0.053	0.069
D	0.33	0.51	0.013	0.020
G	1.27 BSC		0.050 BSC	
H	0.10	0.25	0.004	0.010
J	0.19	0.25	0.007	0.010
K	0.40	1.27	0.016	0.050
M	0°	8°	0°	8°
N	0.25	0.50	0.010	0.020
S	5.80	6.20	0.228	0.244

OBSOLETE
 THIS DEVICE IS OBSOLETE
 PLEASE CONTACT YOUR ON SEMICONDUCTOR
 REPRESENTATIVE FOR INFORMATION

ON Semiconductor and **ON** are registered trademarks of Semiconductor Components Industries, LLC (SCILLC). SCILLC reserves the right to make changes without further notice to any products herein. SCILLC makes no warranty, representation or guarantee regarding the suitability of its products for any particular purpose, nor does SCILLC assume any liability arising out of the application or use of any product or circuit, and specifically disclaims any and all liability, including without limitation special, consequential or incidental damages. "Typical" parameters which may be provided in SCILLC data sheets and/or specifications can and do vary in different applications and actual performance may vary over time. All operating parameters, including "Typicals" must be validated for each customer application by customer's technical experts. SCILLC does not convey any license under its patent rights nor the rights of others. SCILLC products are not designed, intended, or authorized for use as components in systems intended for surgical implant into the body, or other applications intended to support or sustain life, or for any other application in which the failure of the SCILLC product could create a situation where personal injury or death may occur. Should Buyer purchase or use SCILLC products for any such unintended or unauthorized application, Buyer shall indemnify and hold SCILLC and its officers, employees, subsidiaries, affiliates, and distributors harmless against all claims, costs, damages, and expenses, and reasonable attorney fees arising out of, directly or indirectly, any claim of personal injury or death associated with such unintended or unauthorized use, even if such claim alleges that SCILLC was negligent regarding the design or manufacture of the part. SCILLC is an Equal Opportunity/Affirmative Action Employer. This literature is subject to all applicable copyright laws and is not for resale in any manner.

PUBLICATION ORDERING INFORMATION

LITERATURE FULFILLMENT:

Literature Distribution Center for ON Semiconductor
 P.O. Box 5163, Denver, Colorado 80217 USA
Phone: 303-675-2175 or 800-344-3860 Toll Free USA/Canada
Fax: 303-675-2176 or 800-344-3867 Toll Free USA/Canada
Email: orderlit@onsemi.com

N. American Technical Support: 800-282-9855 Toll Free
 USA/Canada
Europe, Middle East and Africa Technical Support:
 Phone: 421 33 790 2910
Japan Customer Focus Center
 Phone: 81-3-5773-3850

ON Semiconductor Website: www.onsemi.com
Order Literature: <http://www.onsemi.com/orderlit>

For additional information, please contact your local
 Sales Representative