



# MC33272A MC33274A

## Single Supply, High Slew Rate Low Input Offset Voltage, Bipolar Operational Amplifiers

The MC33272/74 series of monolithic operational amplifiers are quality fabricated with innovative Bipolar design concepts. This dual and quad operational amplifier series incorporates Bipolar inputs along with a patented Zip-R-Trim element for input offset voltage reduction. The MC33272/74 series of operational amplifiers exhibits low input offset voltage and high gain bandwidth product. Dual-doublet frequency compensation is used to increase the slew rate while maintaining low input noise characteristics. Its all NPN output stage exhibits no deadband crossover distortion, large output voltage swing, and an excellent phase and gain margin. It also provides a low open loop high frequency output impedance with symmetrical source and sink AC frequency performance.

The MC33272/74 series is specified over  $-40^{\circ}$  to  $+85^{\circ}\text{C}$  and are available in plastic DIP and SOIC surface mount packages.

- Input Offset Voltage Trimmed to  $100\ \mu\text{V}$  (Typ)
- Low Input Bias Current:  $300\ \text{nA}$
- Low Input Offset Current:  $3.0\ \text{nA}$
- High Input Resistance:  $16\ \text{M}\Omega$
- Low Noise:  $18\ \text{nV}/\sqrt{\text{Hz}}$  @  $1.0\ \text{kHz}$
- High Gain Bandwidth Product:  $24\ \text{MHz}$  @  $100\ \text{kHz}$
- High Slew Rate:  $10\ \text{V}/\mu\text{s}$
- Power Bandwidth:  $160\ \text{kHz}$
- Excellent Frequency Stability
- Unity Gain Stable: w/Capacitance Loads to  $500\ \text{pF}$
- Large Output Voltage Swing:  $+14.1\ \text{V}/-14.6\ \text{V}$
- Low Total Harmonic Distortion:  $0.003\%$
- Power Supply Drain Current:  $2.15\ \text{mA}$  per Amplifier
- Single or Split Supply Operation:  $+3.0\ \text{V}$  to  $+36\ \text{V}$  or  $\pm 1.5\ \text{V}$  to  $\pm 18\ \text{V}$
- ESD Diodes Provide Added Protection to the Inputs

### ORDERING INFORMATION

| Op Amp Function | Device    | Operating Temperature Range                  | Package     |
|-----------------|-----------|--|-------------|
| Dual            | MC33272AD | $T_A = -40^{\circ}$ to $+85^{\circ}\text{C}$ | SO-8        |
|                 | MC33272AP |  | Plastic DIP |
| Quad            | MC33274AD |  | SO-14       |
|                 | MC33274AP |  | Plastic DIP |

### HIGH PERFORMANCE OPERATIONAL AMPLIFIERS SEMICONDUCTOR TECHNICAL DATA

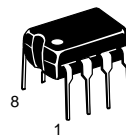

**P SUFFIX**  
PLASTIC PACKAGE  
CASE 626



**D SUFFIX**  
PLASTIC PACKAGE  
CASE 751  
(SO-8)

#### PIN CONNECTIONS

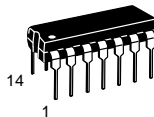
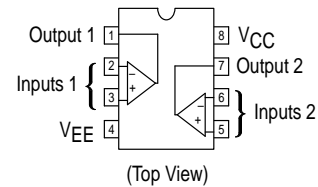

**P SUFFIX**  
PLASTIC PACKAGE  
CASE 646

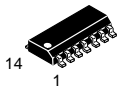

**D SUFFIX**  
PLASTIC PACKAGE  
CASE 751A  
(SO-14)

#### PIN CONNECTIONS

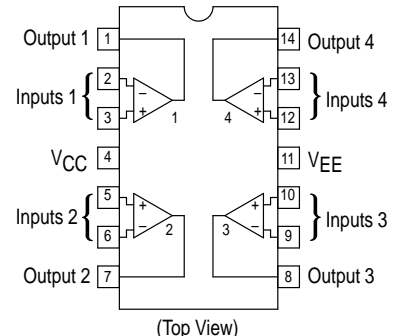

# MC33272A MC33274A

## MAXIMUM RATINGS

| Rating                                 | Symbol               | Value       | Unit |
|--|----------------------|-------------|------|
| Supply Voltage                         | $V_{CC}$ to $V_{EE}$ | +36         | V    |
| Input Differential Voltage Range       | $V_{IDR}$            | (Note 1)    | V    |
| Input Voltage Range                    | $V_{IR}$             | (Note 1)    | V    |
| Output Short Circuit Duration (Note 2) | $t_{SC}$             | Indefinite  | sec  |
| Maximum Junction Temperature           | $T_J$                | +150        | °C   |
| Storage Temperature                    | $T_{stg}$            | -60 to +150 | °C   |
| Maximum Power Dissipation              | $P_D$                | (Note 2)    | mW   |

**NOTES:** 1. Either or both input voltages should not exceed  $V_{CC}$  or  $V_{EE}$ .  
 2. Power dissipation must be considered to ensure maximum junction temperature ( $T_J$ ) is not exceeded (see Figure 2).

## DC ELECTRICAL CHARACTERISTICS ( $V_{CC} = +15$ V, $V_{EE} = -15$ V, $T_A = 25^\circ$ C, unless otherwise noted.)

| Characteristics  | Figure                 | Symbol   | Min                                    | Typ  | Max  | Unit       |
|--|------------------------|--|--|--|--|------------|
| Input Offset Voltage ( $R_S = 10 \Omega$ , $V_{CM} = 0$ V, $V_O = 0$ V)<br>( $V_{CC} = +15$ V, $V_{EE} = -15$ V)<br>$T_A = +25^\circ$ C<br>$T_A = -40^\circ$ to $+85^\circ$ C<br>( $V_{CC} = 5.0$ V, $V_{EE} = 0$ )<br>$T_A = +25^\circ$ C | 3                      | $ V_{IO} $   | —                                      | 0.1  | 1.0  | mV         |
| Average Temperature Coefficient of Input Offset Voltage<br>$R_S = 10 \Omega$ , $V_{CM} = 0$ V, $V_O = 0$ V, $T_A = -40^\circ$ to $+85^\circ$ C   | 3                      | $\Delta V_{IO}/\Delta T$   | —                                      | 2.0  | —  | $\mu$ V/°C |
| Input Bias Current ( $V_{CM} = 0$ V, $V_O = 0$ V)<br>$T_A = +25^\circ$ C<br>$T_A = -40^\circ$ to $+85^\circ$ C   | 4, 5                   | $I_{IB}$   | —                                      | 300  | 650  | nA         |
| Input Offset Current ( $V_{CM} = 0$ V, $V_O = 0$ V)<br>$T_A = +25^\circ$ C<br>$T_A = -40^\circ$ to $+85^\circ$ C   |                        | $ I_{IO} $   | —                                      | 3.0  | 65   | nA         |
| Common Mode Input Voltage Range ( $\Delta V_{IO} = 5.0$ mV, $V_O = 0$ V)<br>$T_A = +25^\circ$ C  | 6                      | $V_{ICR}$  | $V_{EE}$ to $(V_{CC} - 1.8)$           |  |  | V          |
| Large Signal Voltage Gain ( $V_O = 0$ V to 10 V, $R_L = 2.0$ k $\Omega$ )<br>$T_A = +25^\circ$ C<br>$T_A = -40^\circ$ to $+85^\circ$ C   | 7                      | $A_{VOL}$  | 90<br>86                               | 100  | —  | dB         |
| Output Voltage Swing ( $V_{ID} = \pm 1.0$ V)<br>( $V_{CC} = +15$ V, $V_{EE} = -15$ V)<br>$R_L = 2.0$ k $\Omega$<br>$R_L = 10$ k $\Omega$<br>( $V_{CC} = 5.0$ V, $V_{EE} = 0$ V)<br>$R_L = 2.0$ k $\Omega$<br>$R_L = 2.0$ k $\Omega$        | 8, 9, 12<br><br>10, 11 | $V_{O+}$<br>$V_{O-}$<br>$V_{O+}$<br>$V_{O-}$<br><br>$V_{OL}$<br>$V_{OH}$ | 13.4<br>—<br>13.4<br>—<br><br>—<br>3.7 | 13.9<br>-13.9<br>14<br>-14.7<br><br>—<br>— | —<br>-13.5<br>—<br>-14.1<br><br>0.2<br>5.0 | V          |
| Common Mode Rejection ( $V_{in} = +13.2$ V to -15 V)   | 13                     | CMR  | 80                                     | 100  | —  | dB         |
| Power Supply Rejection<br>$V_{CC}/V_{EE} = +15$ V/-15 V, +5.0 V/-15 V, +15 V/-5.0 V  | 14, 15                 | PSR  | 80                                     | 105  | —  | dB         |
| Output Short Circuit Current ( $V_{ID} = 1.0$ V, Output to Ground)<br>Source<br>Sink   | 16                     | $I_{SC}$   | +25<br>-25                             | +37<br>-37                                 | —<br>—                                     | mA         |
| Power Supply Current Per Amplifier ( $V_O = 0$ V)<br>( $V_{CC} = +15$ V, $V_{EE} = -15$ V)<br>$T_A = +25^\circ$ C<br>$T_A = -40^\circ$ to $+85^\circ$ C<br>( $V_{CC} = 5.0$ V, $V_{EE} = 0$ V)<br>$T_A = +25^\circ$ C                      | 17                     | $I_{CC}$   | —<br>—<br>—                            | 2.15<br>—<br>—                             | 2.75<br>3.0<br>2.75                        | mA         |

# MC33272A MC33274A

**AC ELECTRICAL CHARACTERISTICS** ( $V_{CC} = +15\text{ V}$ ,  $V_{EE} = -15\text{ V}$ ,  $T_A = 25^\circ\text{C}$ , unless otherwise noted.)

| Characteristics   | Figure     | Symbol   | Min | Typ   | Max | Unit                         |
|---|------------|----------|-----|-------|-----|------------------------------|
| Slew Rate<br>( $V_{in} = -10\text{ V}$ to $+10\text{ V}$ , $R_L = 2.0\text{ k}\Omega$ , $C_L = 100\text{ pF}$ , $A_V = +1.0$ )                  | 18, 33     | SR       | 8.0 | 10    | —   | V/ $\mu\text{s}$             |
| Gain Bandwidth Product ( $f = 100\text{ kHz}$ )   | 19         | GBW      | 17  | 24    | —   | MHz                          |
| AC Voltage Gain ( $R_L = 2.0\text{ k}\Omega$ , $V_O = 0\text{ V}$ , $f = 20\text{ kHz}$ )   | 20, 21, 22 | $A_{VO}$ | —   | 65    | —   | dB                           |
| Unity Gain Frequency (Open Loop)  |            | $f_U$    | —   | 5.5   | —   | MHz                          |
| Gain Margin ( $R_L = 2.0\text{ k}\Omega$ , $C_L = 0\text{ pF}$ )  | 23, 24, 26 | $A_m$    | —   | 12    | —   | dB                           |
| Phase Margin ( $R_L = 2.0\text{ k}\Omega$ , $C_L = 0\text{ pF}$ )   | 23, 25, 26 | $\phi_m$ | —   | 55    | —   | Degrees                      |
| Channel Separation ( $f = 20\text{ Hz}$ to $20\text{ kHz}$ )  | 27         | CS       | —   | -120  | —   | dB                           |
| Power Bandwidth ( $V_O = 20\text{ V}_{pp}$ , $R_L = 2.0\text{ k}\Omega$ , $\text{THD} \leq 1.0\%$ )   |            | BWP      | —   | 160   | —   | kHz                          |
| Total Harmonic Distortion<br>( $R_L = 2.0\text{ k}\Omega$ , $f = 20\text{ Hz}$ to $20\text{ kHz}$ , $V_O = 3.0\text{ V}_{rms}$ , $A_V = +1.0$ ) | 28         | THD      | —   | 0.003 | —   | %                            |
| Open Loop Output Impedance ( $V_O = 0\text{ V}$ , $f = 6.0\text{ MHz}$ )  | 29         | $ Z_O $  | —   | 35    | —   | $\Omega$                     |
| Differential Input Resistance ( $V_{CM} = 0\text{ V}$ )   |            | $R_{IN}$ | —   | 16    | —   | $M\Omega$                    |
| Differential Input Capacitance ( $V_{CM} = 0\text{ V}$ )  |            | $C_{IN}$ | —   | 3.0   | —   | pF                           |
| Equivalent Input Noise Voltage ( $R_S = 100\ \Omega$ , $f = 1.0\text{ kHz}$ )   | 30         | $e_n$    | —   | 18    | —   | $\text{nV}/\sqrt{\text{Hz}}$ |
| Equivalent Input Noise Current ( $f = 1.0\text{ kHz}$ )   | 31         | $i_n$    | —   | 0.5   | —   | $\text{pA}/\sqrt{\text{Hz}}$ |

**Figure 1. Equivalent Circuit Schematic  
(Each Amplifier)**

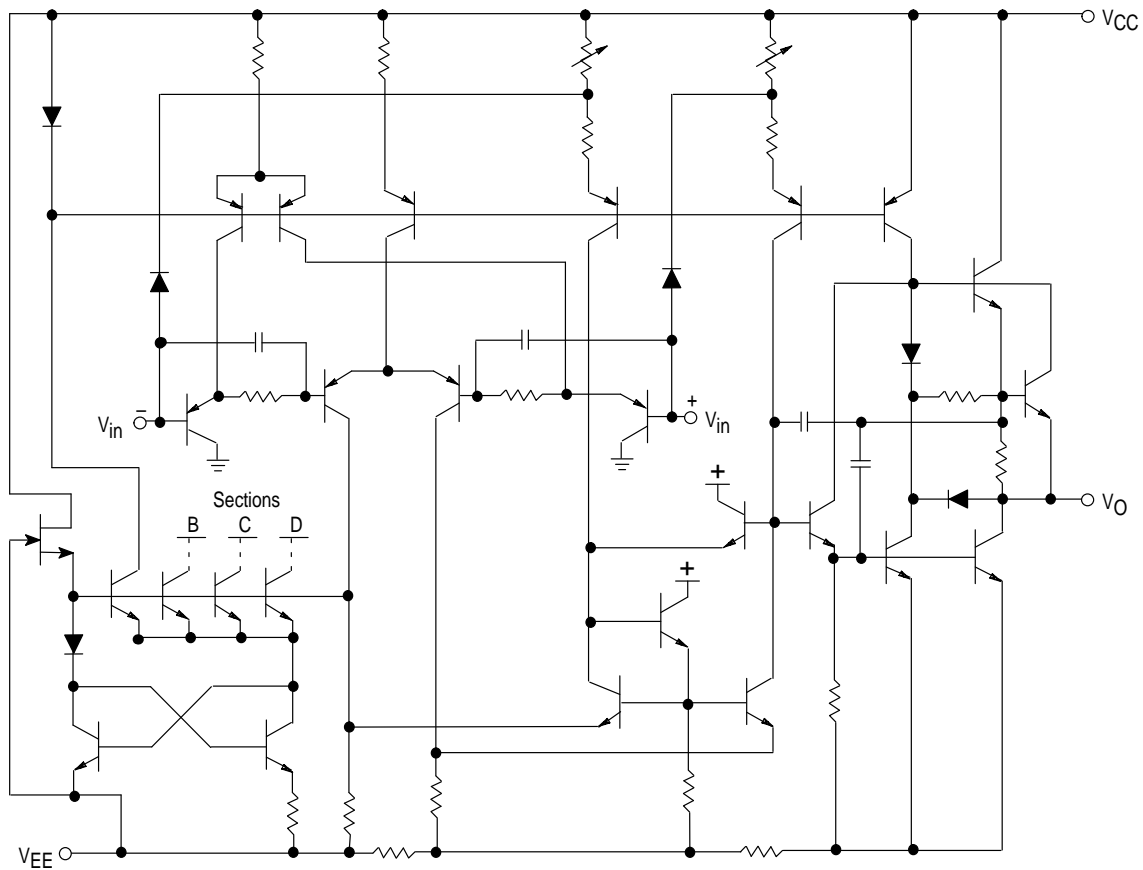

# MC33272A MC33274A

**Figure 2. Maximum Power Dissipation versus Temperature**

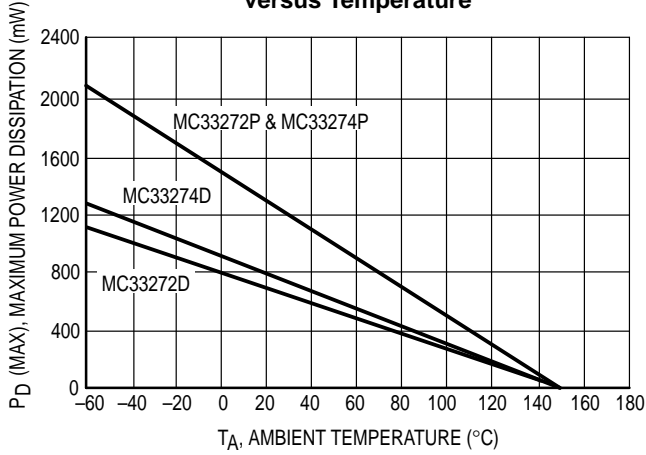

**Figure 3. Input Offset Voltage versus Temperature for Typical Units**

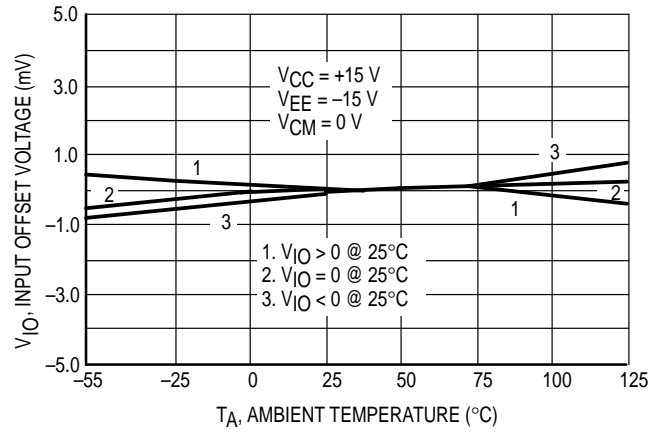

**Figure 4. Input Bias Current versus Common Mode Voltage**

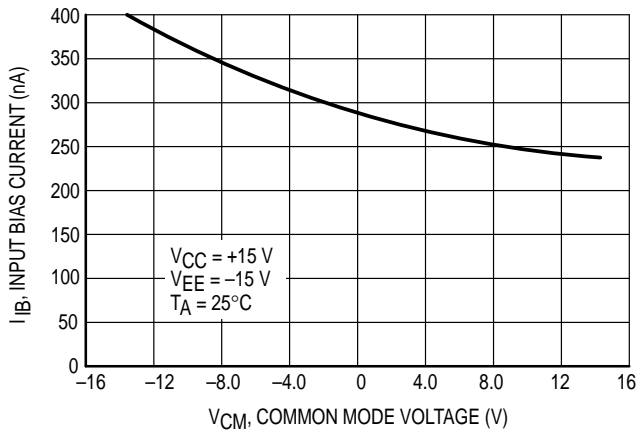

**Figure 5. Input Bias Current versus Temperature**

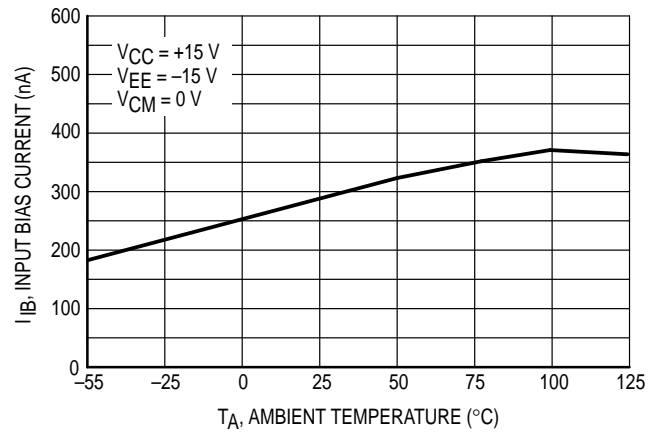

**Figure 6. Input Common Mode Voltage Range versus Temperature**

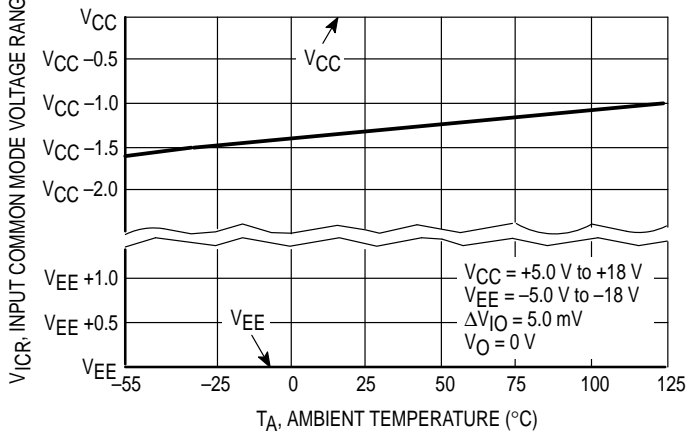

**Figure 7. Open Loop Voltage Gain versus Temperature**

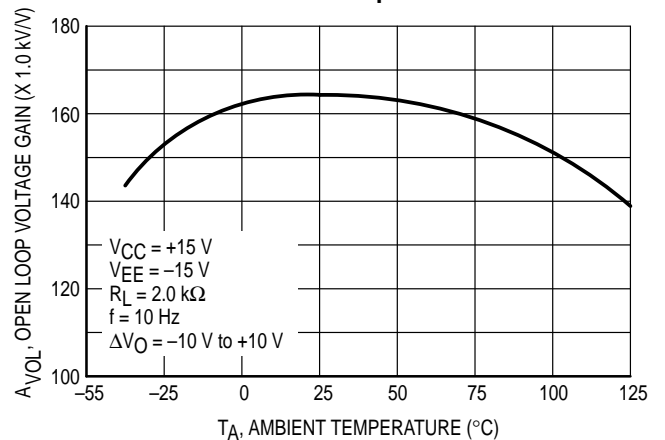

Figure 8. Split Supply Output Voltage Swing versus Supply Voltage

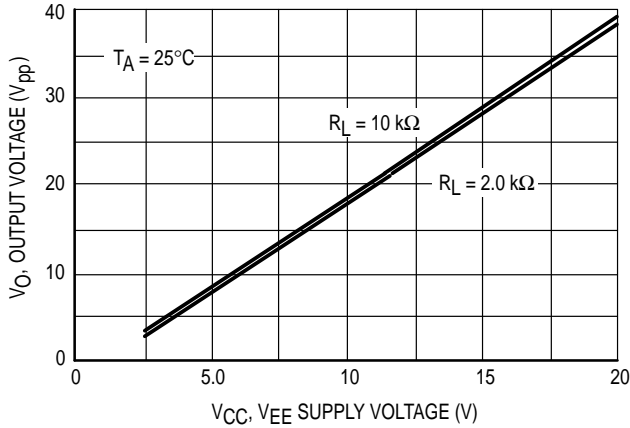

Figure 9. Split Supply Output Saturation Voltage versus Load Current

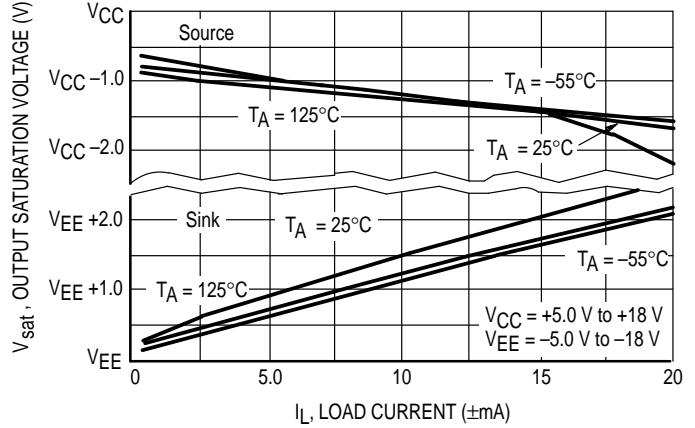

Figure 10. Single Supply Output Saturation Voltage versus Load Resistance to Ground

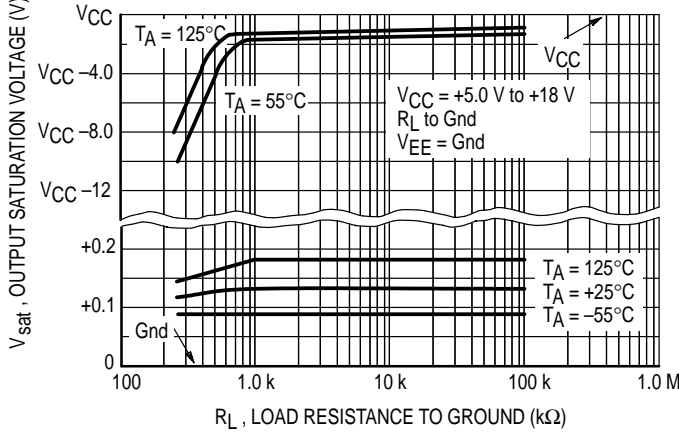

Figure 11. Single Supply Output Saturation Voltage versus Load Resistance to V<sub>CC</sub>

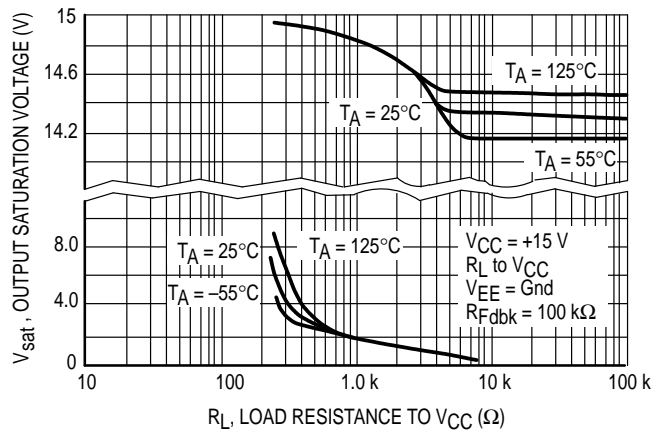

Figure 12. Output Voltage versus Frequency

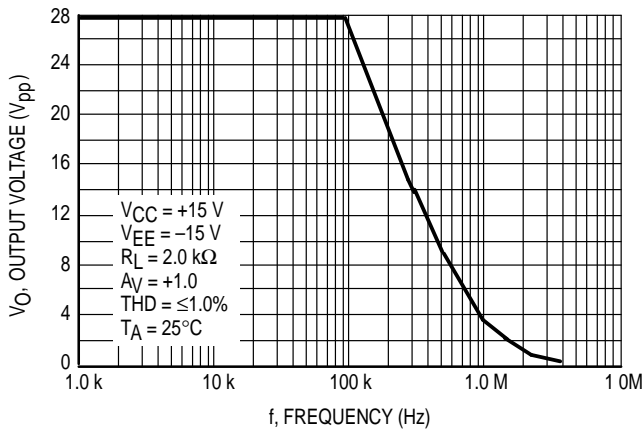

Figure 13. Common Mode Rejection versus Frequency

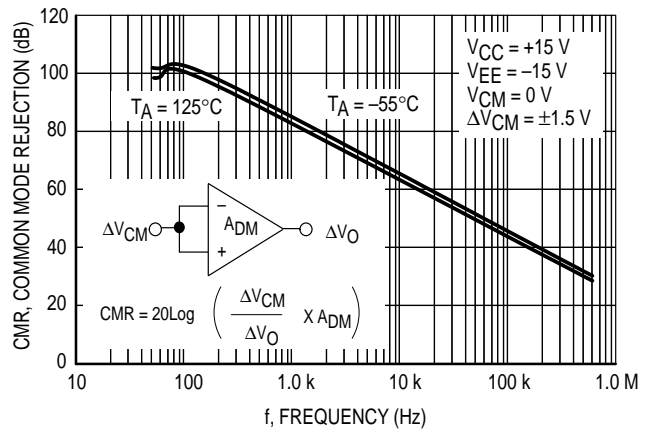

Figure 14. Positive Power Supply Rejection versus Frequency

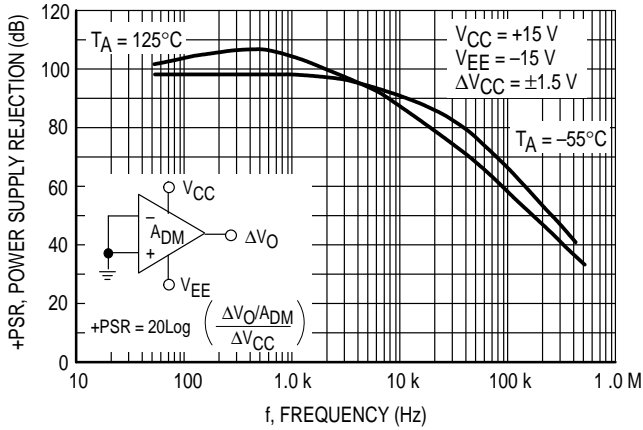

Figure 15. Negative Power Supply Rejection versus Frequency

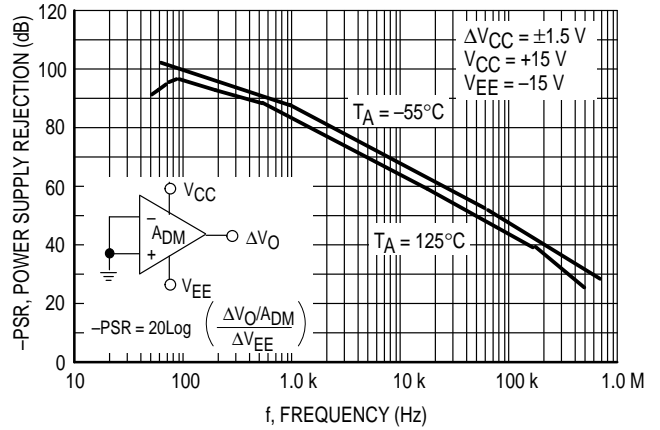

Figure 16. Output Short Circuit Current versus Temperature

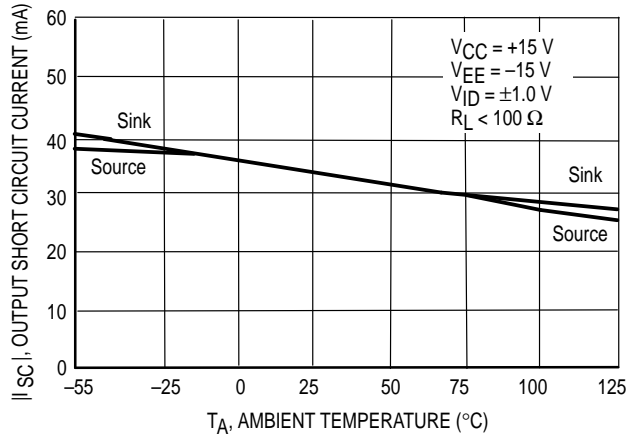

Figure 17. Supply Current versus Supply Voltage

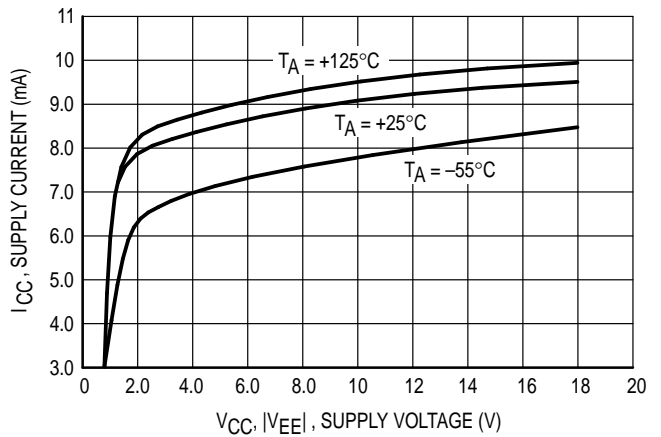

Figure 18. Normalized Slew Rate versus Temperature

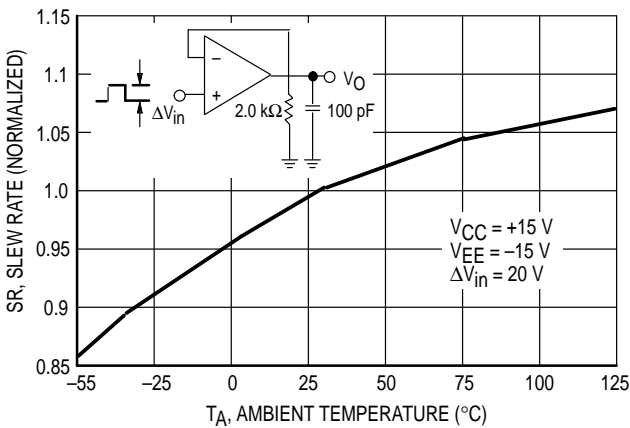

Figure 19. Gain Bandwidth Product versus Temperature

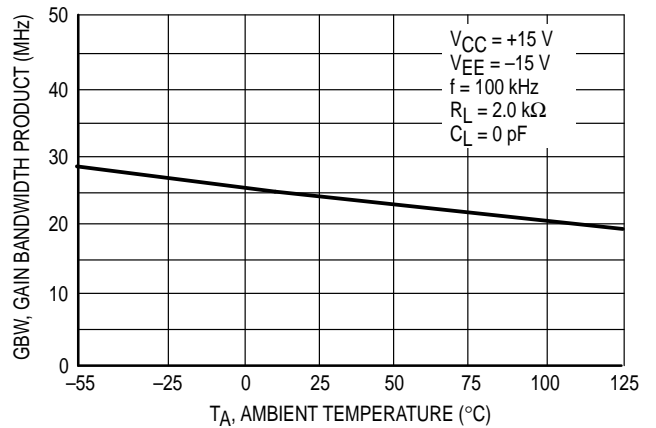

Figure 20. Voltage Gain and Phase versus Frequency

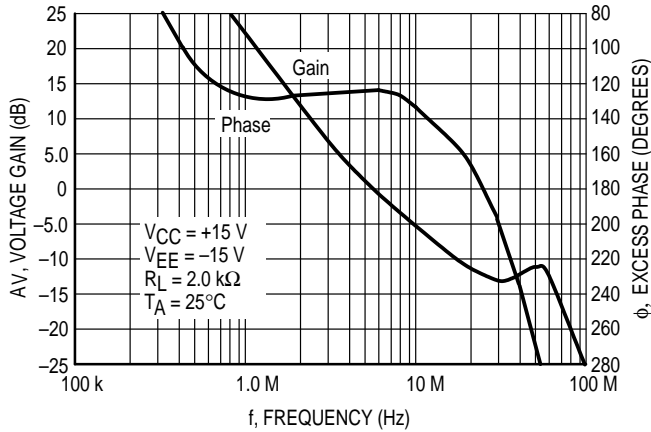

Figure 21. Gain and Phase versus Frequency

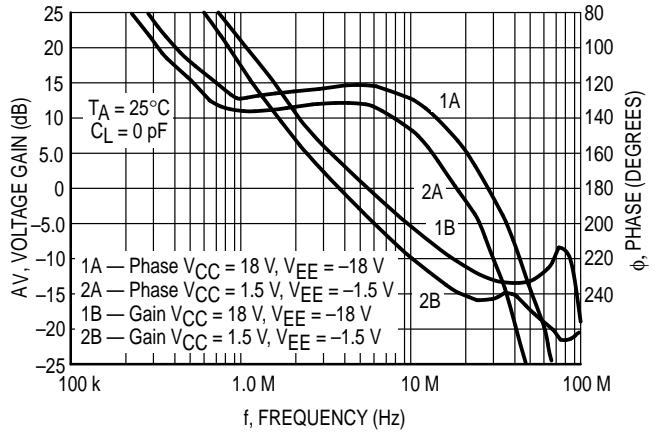

Figure 22. Open Loop Voltage Gain and Phase versus Frequency

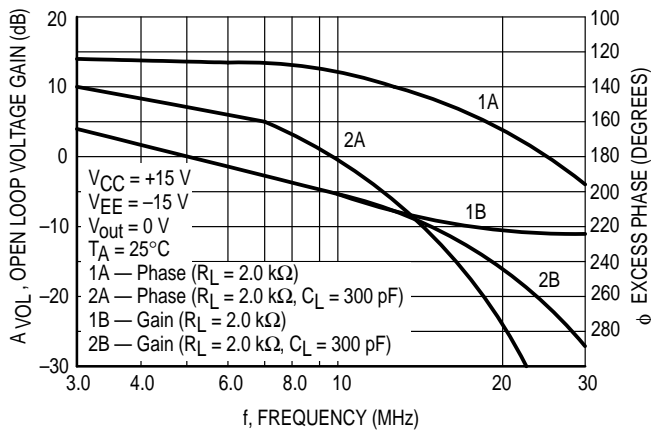

Figure 23. Open Loop Gain Margin and Phase Margin versus Output Load Capacitance

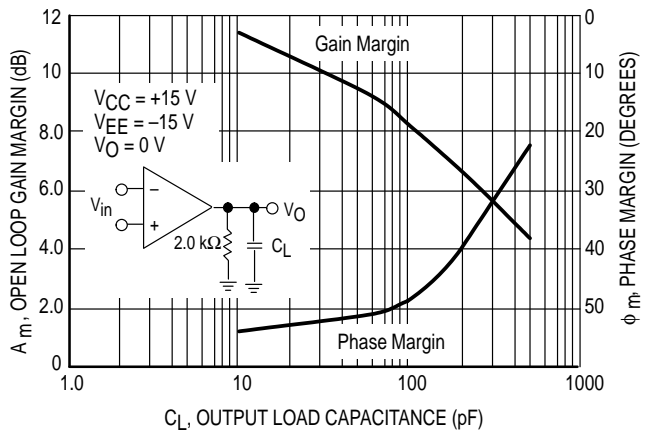

Figure 24. Open Loop Gain Margin versus Temperature

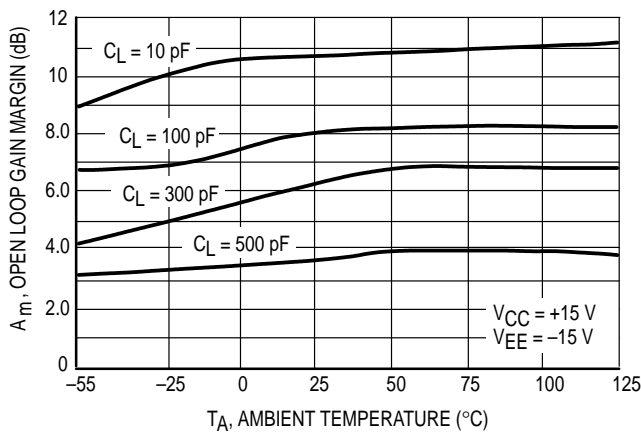

Figure 25. Phase Margin versus Temperature

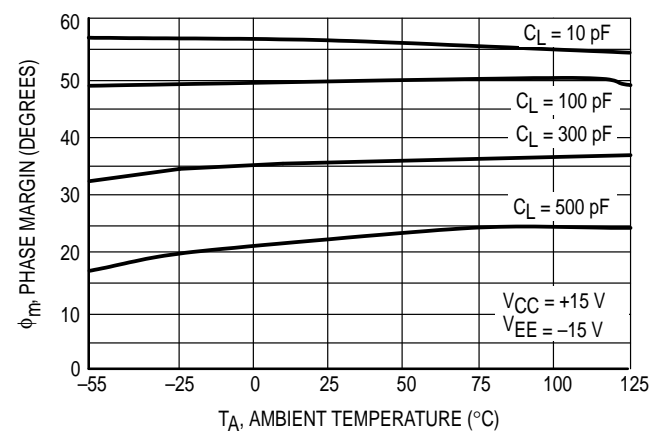

Figure 26. Phase Margin and Gain Margin versus Differential Source Resistance

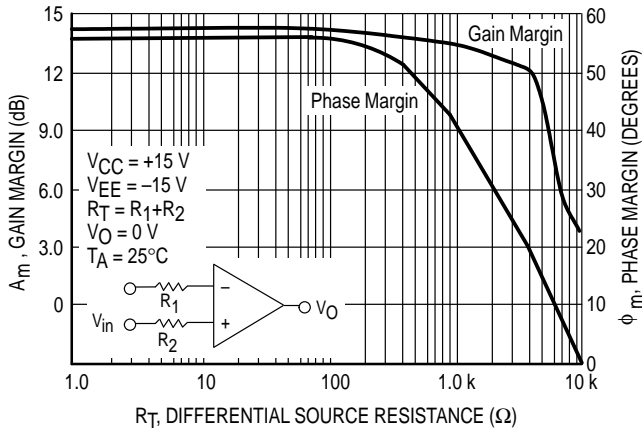

Figure 27. Channel Separation versus Frequency

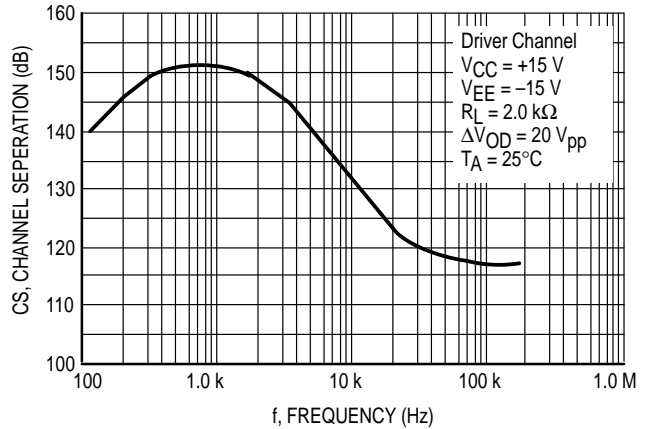

Figure 28. Total Harmonic Distortion versus Frequency

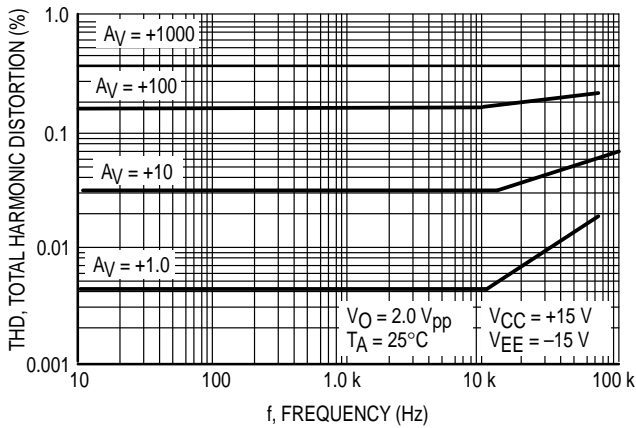

Figure 29. Output Impedance versus Frequency

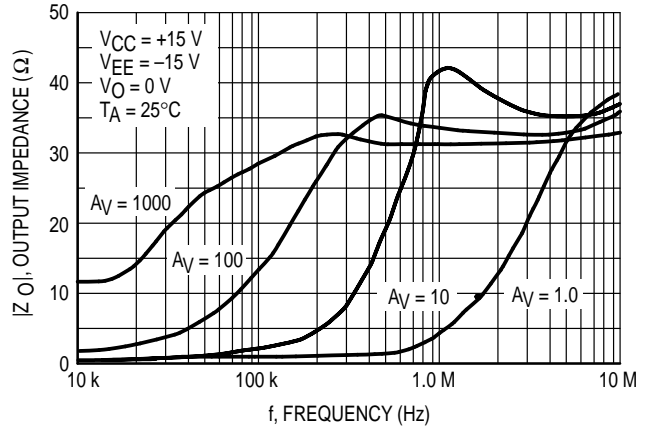

Figure 30. Input Referred Noise Voltage versus Frequency

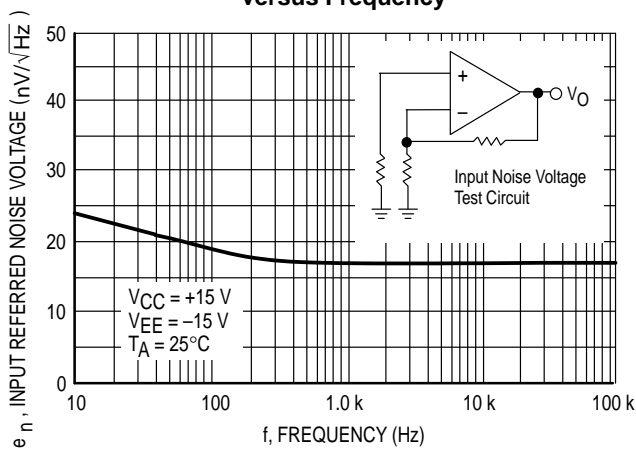
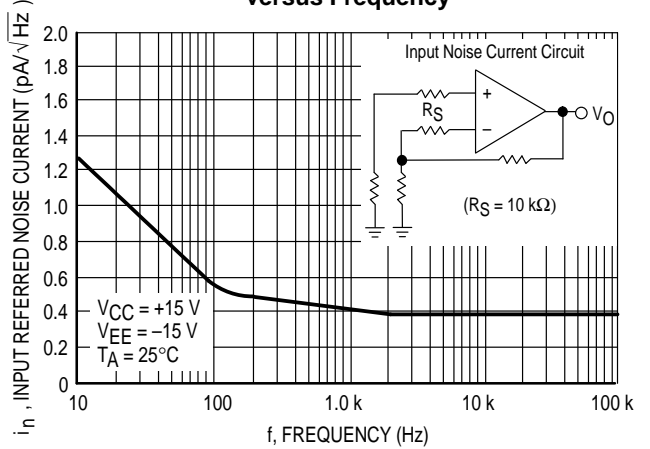

Figure 31. Input Referred Noise Current versus Frequency





# MC33272A MC33274A

**Figure 32. Percent Overshoot versus Load Capacitance**

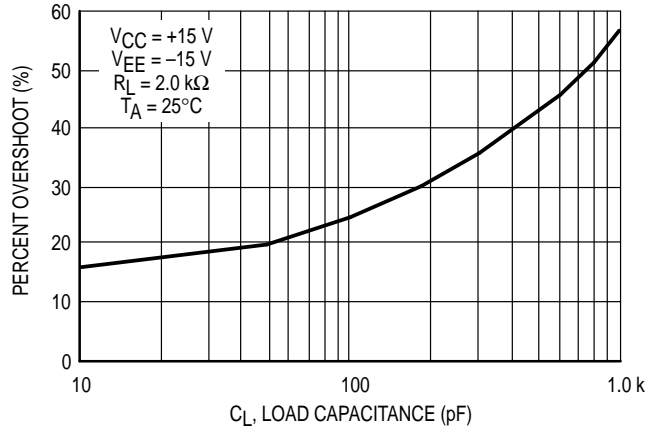

**Figure 33. Noninverting Amplifier Slew Rate for the MC33274**

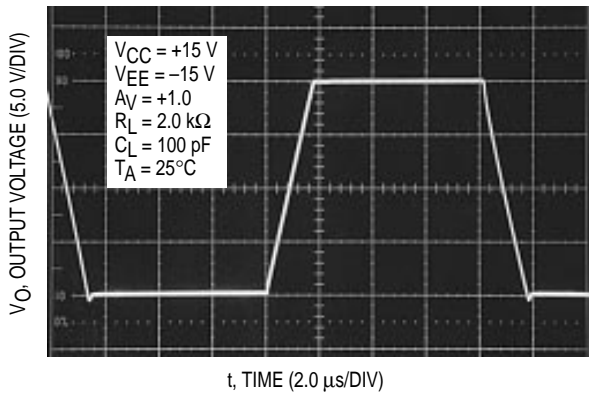

**Figure 34. Noninverting Amplifier Overshoot for the MC33274**

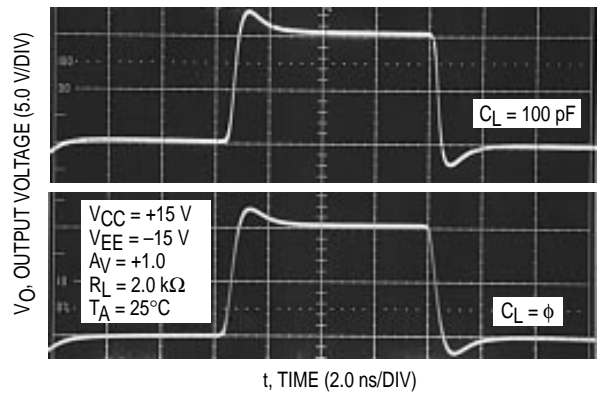

**Figure 35. Small Signal Transient Response for MC33274**

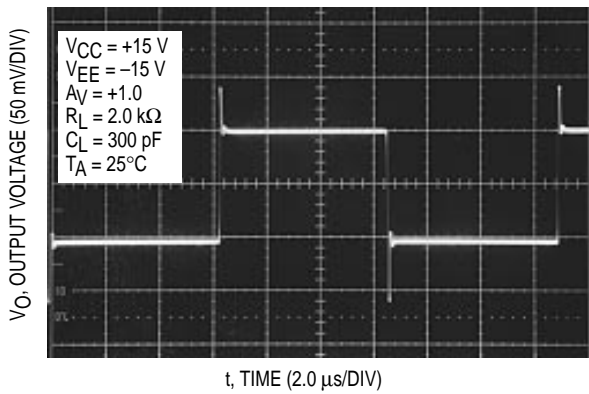

**Figure 36. Large Signal Transient Response for MC33274**

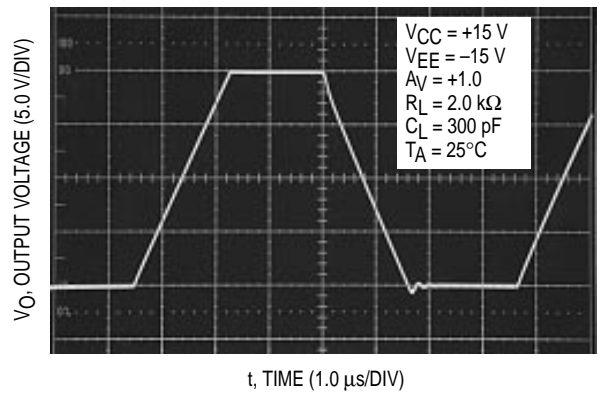

# MC33272A MC33274A

## OUTLINE DIMENSIONS

### P SUFFIX PLASTIC PACKAGE CASE 626-05 ISSUE K

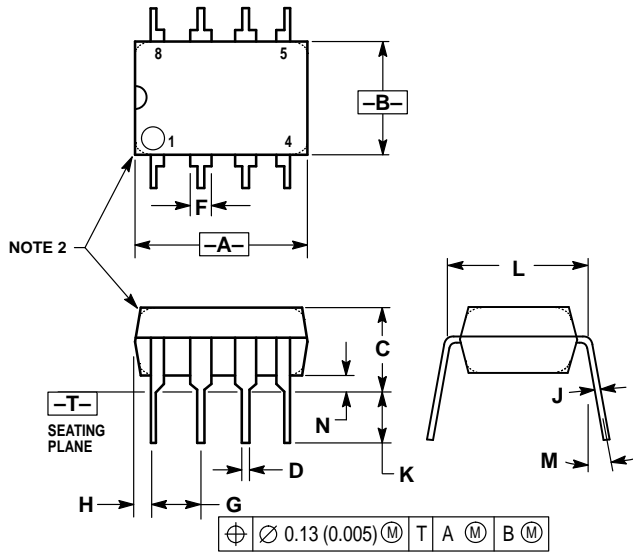

- NOTES:
1. DIMENSION L TO CENTER OF LEAD WHEN FORMED PARALLEL.
  2. PACKAGE CONTOUR OPTIONAL (ROUND OR SQUARE CORNERS).
  3. DIMENSIONING AND TOLERANCING PER ANSI Y14.5M, 1982.

| DIM | MILLIMETERS |       | INCHES    |       |
|-----|-------------|-------|-----------|-------|
|     | MIN         | MAX   | MIN       | MAX   |
| A   | 9.40        | 10.16 | 0.370     | 0.400 |
| B   | 6.10        | 6.60  | 0.240     | 0.260 |
| C   | 3.94        | 4.45  | 0.155     | 0.175 |
| D   | 0.38        | 0.51  | 0.015     | 0.020 |
| F   | 1.02        | 1.78  | 0.040     | 0.070 |
| G   | 2.54 BSC    |       | 0.100 BSC |       |
| H   | 0.76        | 1.27  | 0.030     | 0.050 |
| J   | 0.20        | 0.30  | 0.008     | 0.012 |
| K   | 2.92        | 3.43  | 0.115     | 0.135 |
| L   | 7.62 BSC    |       | 0.300 BSC |       |
| M   | —           |       | 10°       |       |
| N   | 0.76        | 1.01  | 0.030     | 0.040 |

### D SUFFIX PLASTIC PACKAGE CASE 751-05 (SO-8) ISSUE R

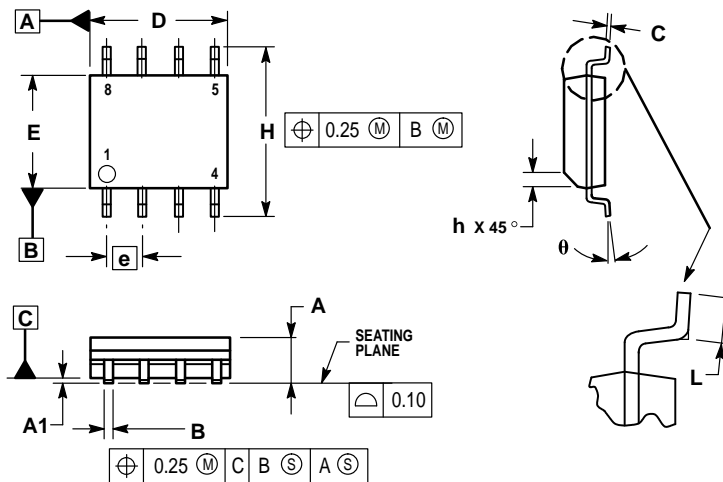

- NOTES:
1. DIMENSIONING AND TOLERANCING PER ASME Y14.5M, 1994.
  2. DIMENSIONS ARE IN MILLIMETERS.
  3. DIMENSION D AND E DO NOT INCLUDE MOLD PROTRUSION.
  4. MAXIMUM MOLD PROTRUSION 0.15 PER SIDE.
  5. DIMENSION B DOES NOT INCLUDE MOLD PROTRUSION. ALLOWABLE DAMBAR PROTRUSION SHALL BE 0.127 TOTAL IN EXCESS OF THE B DIMENSION AT MAXIMUM MATERIAL CONDITION.

| DIM | MILLIMETERS |      |
|-----|-------------|------|
|     | MIN         | MAX  |
| A   | 1.35        | 1.75 |
| A1  | 0.10        | 0.25 |
| B   | 0.35        | 0.49 |
| C   | 0.18        | 0.25 |
| D   | 4.80        | 5.00 |
| E   | 3.80        | 4.00 |
| e   | 1.27 BSC    |      |
| H   | 5.80        | 6.20 |
| h   | 0.25        | 0.50 |
| L   | 0.40        | 1.25 |
| θ   | 0° 7°       |      |

# MC33272A MC33274A

## OUTLINE DIMENSIONS

### P SUFFIX PLASTIC PACKAGE CASE 646-06 ISSUE L

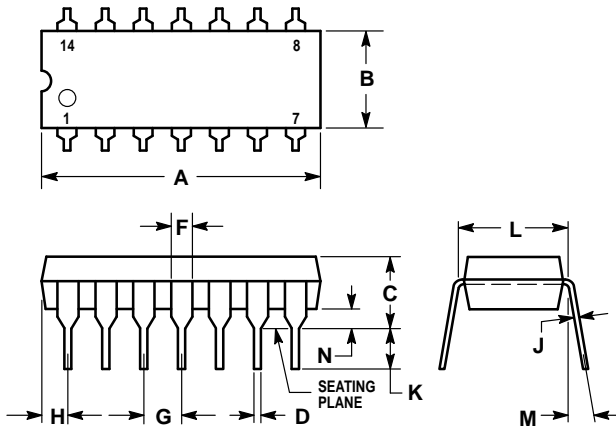

NOTES:

- LEADS WITHIN 0.13 (0.005) RADIUS OF TRUE POSITION AT SEATING PLANE AT MAXIMUM MATERIAL CONDITION.
- DIMENSION L TO CENTER OF LEADS WHEN FORMED PARALLEL.
- DIMENSION B DOES NOT INCLUDE MOLD FLASH.
- ROUNDED CORNERS OPTIONAL.

| DIM | INCHES    |       | MILLIMETERS |       |
|-----|-----------|-------|-------------|-------|
|     | MIN       | MAX   | MIN         | MAX   |
| A   | 0.715     | 0.770 | 18.16       | 19.56 |
| B   | 0.240     | 0.260 | 6.10        | 6.60  |
| C   | 0.145     | 0.185 | 3.69        | 4.69  |
| D   | 0.015     | 0.021 | 0.38        | 0.53  |
| F   | 0.040     | 0.070 | 1.02        | 1.78  |
| G   | 0.100 BSC |       | 2.54 BSC    |       |
| H   | 0.052     | 0.095 | 1.32        | 2.41  |
| J   | 0.008     | 0.015 | 0.20        | 0.38  |
| K   | 0.115     | 0.135 | 2.92        | 3.43  |
| L   | 0.300 BSC |       | 7.62 BSC    |       |
| M   | 0°        | 10°   | 0°          | 10°   |
| N   | 0.015     | 0.039 | 0.39        | 1.01  |

### D SUFFIX PLASTIC PACKAGE CASE 751A-03 (SO-14) ISSUE F

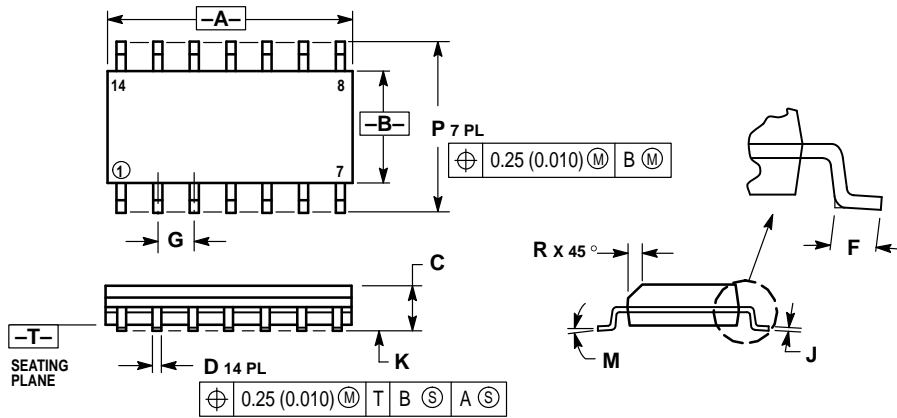

NOTES:

- DIMENSIONING AND TOLERANCING PER ANSI Y14.5M, 1982.
- CONTROLLING DIMENSION: MILLIMETER.
- DIMENSIONS A AND B DO NOT INCLUDE MOLD PROTRUSION.
- MAXIMUM MOLD PROTRUSION 0.15 (0.006) PER SIDE.
- DIMENSION D DOES NOT INCLUDE DAMBAR PROTRUSION. ALLOWABLE DAMBAR PROTRUSION SHALL BE 0.127 (0.005) TOTAL IN EXCESS OF THE D DIMENSION AT MAXIMUM MATERIAL CONDITION.

| DIM | MILLIMETERS |      | INCHES    |       |
|-----|-------------|------|-----------|-------|
|     | MIN         | MAX  | MIN       | MAX   |
| A   | 8.55        | 8.75 | 0.337     | 0.344 |
| B   | 3.80        | 4.00 | 0.150     | 0.157 |
| C   | 1.35        | 1.75 | 0.054     | 0.068 |
| D   | 0.35        | 0.49 | 0.014     | 0.019 |
| F   | 0.40        | 1.25 | 0.016     | 0.049 |
| G   | 1.27 BSC    |      | 0.050 BSC |       |
| J   | 0.19        | 0.25 | 0.008     | 0.009 |
| K   | 0.10        | 0.25 | 0.004     | 0.009 |
| M   | 0°          | 7°   | 0°        | 7°    |
| P   | 5.80        | 6.20 | 0.228     | 0.244 |
| R   | 0.25        | 0.50 | 0.010     | 0.019 |

# MC33272A MC33274A

Motorola reserves the right to make changes without further notice to any products herein. Motorola makes no warranty, representation or guarantee regarding the suitability of its products for any particular purpose, nor does Motorola assume any liability arising out of the application or use of any product or circuit, and specifically disclaims any and all liability, including without limitation consequential or incidental damages. "Typical" parameters which may be provided in Motorola data sheets and/or specifications can and do vary in different applications and actual performance may vary over time. All operating parameters, including "Typicals" must be validated for each customer application by customer's technical experts. Motorola does not convey any license under its patent rights nor the rights of others. Motorola products are not designed, intended, or authorized for use as components in systems intended for surgical implant into the body, or other applications intended to support or sustain life, or for any other application in which the failure of the Motorola product could create a situation where personal injury or death may occur. Should Buyer purchase or use Motorola products for any such unintended or unauthorized application, Buyer shall indemnify and hold Motorola and its officers, employees, subsidiaries, affiliates, and distributors harmless against all claims, costs, damages, and expenses, and reasonable attorney fees arising out of, directly or indirectly, any claim of personal injury or death associated with such unintended or unauthorized use, even if such claim alleges that Motorola was negligent regarding the design or manufacture of the part. Motorola and  are registered trademarks of Motorola, Inc. Motorola, Inc. is an Equal Opportunity/Affirmative Action Employer.

**How to reach us:**

**USA/EUROPE/Locations Not Listed:** Motorola Literature Distribution;  
P.O. Box 20912; Phoenix, Arizona 85036. 1-800-441-2447 or 602-303-5454

**MFAX:** RMFAX0@email.sps.mot.com – TOUCHTONE 602-244-6609  
**INTERNET:** <http://Design-NET.com>

**JAPAN:** Nippon Motorola Ltd.; Tatsumi-SPD-JLDC, 6F Seibu-Butsuryu-Center,  
3-14-2 Tatsumi Koto-Ku, Tokyo 135, Japan. 03-81-3521-8315

**ASIA/PACIFIC:** Motorola Semiconductors H.K. Ltd.; 8B Tai Ping Industrial Park,  
51 Ting Kok Road, Tai Po, N.T., Hong Kong. 852-26629298



**MOTOROLA**



MC33272A/D

