

MC34001, MC35001
MC34002, MC35002
MC34004, MC35004

JFET Input Operational Amplifiers

These low cost JFET Input operational amplifiers combine two state-of-the-art linear technologies on a single monolithic integrated circuit. Each internally compensated operational amplifier has well matched high voltage JFET input devices for low input offset voltage. The BIFET technology provides wide bandwidths and fast slew rates with low input bias currents, input offset currents, and supply currents.

The Motorola BIFET family offers single, dual and quad operational amplifiers which are pin-compatible with the industry standard MC1741, MC1458, and the MC3403/LM324 bipolar devices. The MC35001/35002/35004 series are specified over the military operating temperature range of -55° to $+125^{\circ}\text{C}$ and the MC34001/34002/34004 series are specified from 0° to $+70^{\circ}\text{C}$.

- Input Offset Voltage Options of 5.0 mV and 10 mV Maximum
- Low Input Bias Current: 40 pA
- Low Input Offset Current: 10 pA
- Wide Gain Bandwidth: 4.0 MHz
- High Slew Rate: 13 V/ μs
- Low Supply Current: 1.4 mA per Amplifier
- High Input Impedance: $10^{12} \Omega$
- High Common Mode and Supply Voltage Rejection Ratios: 100 dB
- Industry Standard Pinouts

JFET INPUT
OPERATIONAL AMPLIFIERS



P SUFFIX
 PLASTIC PACKAGE
 CASE 626



U SUFFIX
 CERAMIC PACKAGE
 CASE 693



D SUFFIX
 PLASTIC PACKAGE
 CASE 751
 (SO-8)

PIN CONNECTIONS

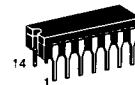
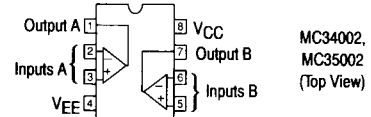
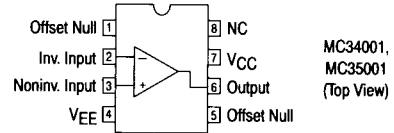

L SUFFIX
 CERAMIC PACKAGE
 CASE 632



P SUFFIX
 PLASTIC PACKAGE
 CASE 646

PIN CONNECTIONS

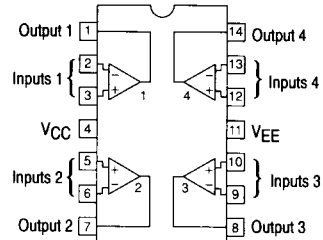

ORDERING INFORMATION

Op Amp Function	Device	Temperature Range	Package
Single	MC34001BD, D	0° to $+70^{\circ}\text{C}$	SO-8
	MC34001BP, P		Plastic DIP
	MC34001BU, U		Ceramic DIP
Dual	MC34002BD, D	0° to $+70^{\circ}\text{C}$	SO-8
	MC34002BP, P		Plastic DIP
	MC35002BU, U		Ceramic DIP
Quad	MC34004BL, L	0° to $+70^{\circ}\text{C}$	Ceramic DIP
	MC34004BP, P		Plastic DIP
	MC35004BL, L		Ceramic DIP
		-55° to $+125^{\circ}\text{C}$	Ceramic DIP

MC34001, MC35001, MC34002, MC35002, MC34004, MC35004

2

MAXIMUM RATINGS

Rating	Symbol	MC35001 MC35002 MC35004	MC34001 MC34002 MC34004	Unit
Supply Voltage	V_{CC}, V_{EE}	± 22	± 18	V
Differential Input Voltage (Note 1)	V_{ID}	± 40	± 30	V
Input Voltage Range	V_{IDR}	± 20	± 16	V
Open Short Circuit Duration	t_{SC}	Continuous		
Operating Ambient Temperature Range	T_A	-55 to +125	0 to +70	$^{\circ}\text{C}$
Operating Junction Temperature Ceramic Package Plastic Package	T_J	150 —	150 150	$^{\circ}\text{C}$
Storage Temperature Range Ceramic Package Plastic Package	T_{stg}	-65 to +150 —	-65 to +150 -55 to +125	$^{\circ}\text{C}$

NOTES: 1. Unless otherwise specified, the absolute maximum negative input voltage is equal to the negative power supply.

ELECTRICAL CHARACTERISTICS ($V_{CC} = +15\text{ V}$, $V_{EE} = -15\text{ V}$, $T_A = 25^{\circ}\text{C}$, unless otherwise noted.)

Characteristics	Symbol	MC35001/35002/35004			MC34001/34002/34004			Unit
		Min	Typ	Max	Min	Typ	Max	
Input Offset Voltage ($R_S \leq 10\text{ k}$) MC3500XB, MC3400XB MC3500X, MC3400X	V_{IO}	— —	3.0 5.0	5.0 10	— —	3.0 5.0	5.0 10	mV
Average Temperature Coefficient of Input Offset Voltage $R_S \leq 10\text{ k}$, $T_A = T_{low}$ to T_{high} (Note 2)	$\Delta V_{IO}/\Delta T$	—	10	—	—	10	—	$\mu\text{V}/^{\circ}\text{C}$
Input Offset Current ($V_{CM} = 0$) (Note 3) MC3500XB, MC3400XB MC3500X, MC3400X	I_{IO}	— —	10 25	50 100	— —	25 25	100 100	pA
Input Bias Current ($V_{CM} = 0$) (Note 3) MC3500XB, MC3400XB MC3500X, MC3400X	I_B	— —	40 50	100 200	— —	50 50	200 200	pA
Input Resistance	r_i	—	10^{12}	—	—	10^{12}	—	Ω
Common Mode Input Voltage Range	V_{ICR}	± 11 —	+15 -12	— —	± 11 —	+15 -12	— —	V
Large Signal Voltage Gain ($V_O = \pm 10\text{ V}$, $R_L = 2.0\text{ k}$) MC3500XB, MC3400XB MC3500X, MC3400X	A_{VOL}	50 25	150 100	— —	50 25	150 100	— —	V/mV
Output Voltage Swing ($R_L \geq 10\text{ k}$) ($R_L \geq 2.0\text{ k}$)	V_O	± 12 ± 10	± 14 ± 13	— —	± 12 ± 10	± 14 ± 13	— —	V
Common Mode Rejection Ratio ($R_S \leq 10\text{ k}$) MC3500XB, MC3400XB MC3500X, MC3400X	CMRR	80 —	100 —	— —	80 70	100 100	— —	dB
Supply Voltage Rejection Ratio ($R_S \leq 10\text{ k}$) (Note 4) MC3500XB, MC3400XB MC3500X, MC3400X	PSRR	80 70	100 100	— —	80 70	100 100	— —	dB
Supply Current (Each Amplifier) MC3500XB, MC3400XB MC3500X, MC3400X	I_D	— —	1.4 1.4	2.5 2.7	— —	1.4 1.4	2.5 2.7	mA
Slew Rate ($A_V = 1.0$)	SR	—	13	—	—	13	—	V/ μs
Gain-Bandwidth Product	GBW	—	4.0	—	—	4.0	—	MHz
Equivalent Input Noise Voltage ($R_S = 100\ \Omega$, $f = 1000\text{ Hz}$)	e_n	—	25	—	—	25	—	nV/ $\sqrt{\text{Hz}}$
Equivalent Input Noise Current ($f = 1000\text{ Hz}$)	i_n	—	0.01	—	—	0.01	—	pA/ $\sqrt{\text{Hz}}$

MC34001, MC35001, MC34002, MC35002, MC34004, MC35004

ELECTRICAL CHARACTERISTICS ($V_{CC} = +15\text{ V}$, $V_{EE} = -15\text{ V}$, $T_A = T_{low}$ to T_{high} [Note 2].)

Characteristics	Symbol	MC35001/35002/35004			MC34001/34002/34004			Unit
		Min	Typ	Max	Min	Typ	Max	
Input Offset Voltage ($R_S \leq 10\text{ k}$) MC3500XB, MC3400XB MC3500X, MC3400X	V_{IO}	— —	— —	7.0 14	— —	— —	7.0 13	mV
Input Offset Current ($V_{CM} = 0$) (Note 3) MC3500XB, MC3400XB MC3500X, MC3400X	I_{IO}	— —	— —	40 40	— —	— —	4.0 4.0	nA
Input Bias Current ($V_{CM} = 0$) (Note 3) MC3500XB, MC3400XB MC3500X, MC3400X	I_{IB}	— —	— —	50 50	— —	— —	8.0 8.0	nA
Common Mode Input Voltage Range	V_{ICR}	± 11	—	—	± 11	—	—	V
Large Signal ($V_O = \pm 10\text{ V}$, $R_L = 2.0\text{ k}$) MC3500XB, MC3400XB MC3500X, MC3400X	A_{VOL}	25 15	— —	— —	25 15	— —	— —	V/mV
Output Voltage Swing ($R \geq 10\text{ k}$) ($R \geq 2.0\text{ k}$)	V_O	± 12 ± 10	— —	— —	± 12 ± 10	— —	— —	V
Common Mode Rejection Ratio ($R_S \leq 10\text{ k}$) MC3500XB, MC3400XB MC3500X, MC3400X	CMRR	80 70	— —	— —	80 70	— —	— —	dB
Supply Voltage Rejection Ratio ($R_S \leq 10\text{ k}$) (Note 4) MC3500XB, MC3400XB MC3500X, MC3400X	PSRR	80 70	— —	— —	80 70	— —	— —	dB
Supply Current (Each Amplifier) MC3500XB, MC3400XB MC3500X, MC3400X	I_D	— —	— —	2.8 3.0	— —	— —	2.8 3.0	mA

NOTES: 2. $T_{low} = -55^\circ\text{C}$ for MC35001/35001B, MC35002/35002B, MC35004/35004B
 $T_{high} = +125^\circ\text{C}$ for MC35001/35001B, MC35002/35002B, MC35004/35004B
 $= 0^\circ\text{C}$ for MC34001/34001B, MC34002/35002B, MC34004/34004B
 $= +70^\circ\text{C}$ for MC34001/34001B, MC34002/35002B, MC34004/34004B

- The input bias currents approximately double for every 10°C rise in junction temperature, T_J . Due to limited test time, the input bias currents are correlated to junction temperature. Use of a heatsink is recommended if input bias current is to be kept to a minimum.
- Supply voltage rejection ratio is measured for both supply magnitudes increasing or decreasing simultaneously, in accordance with common practice.

MC34001, MC35001, MC34002, MC35002, MC34004, MC35004

2

Figure 1. Input Bias Current versus Temperature

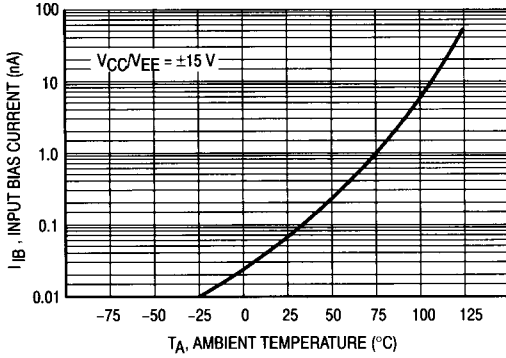

Figure 2. Output Voltage Swing versus Frequency

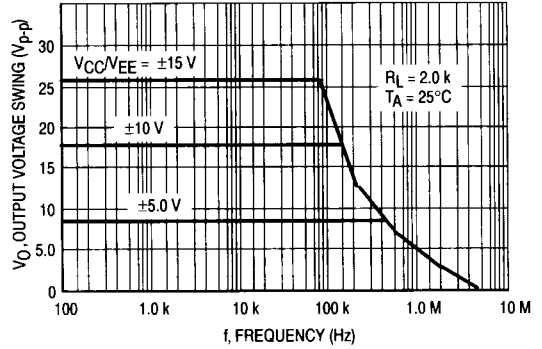

Figure 3. Output Voltage Swing versus Load Resistance

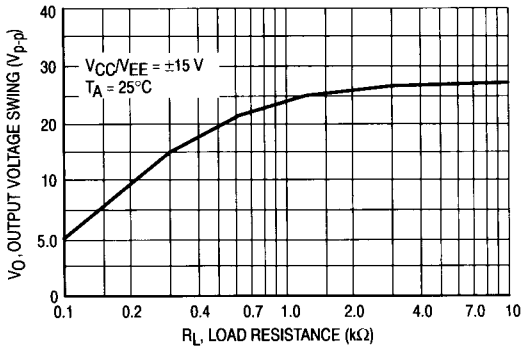

Figure 4. Output Voltage Swing versus Supply Voltage

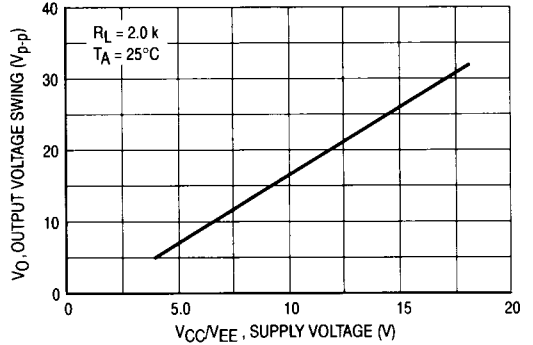

Figure 5. Output Voltage Swing versus Temperature

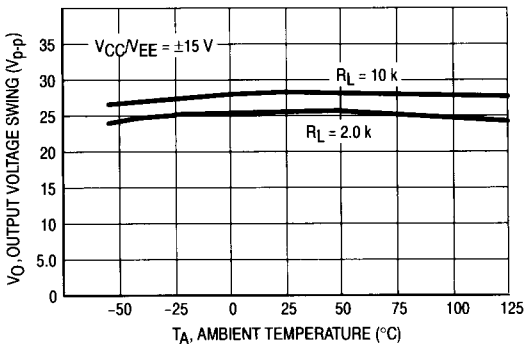
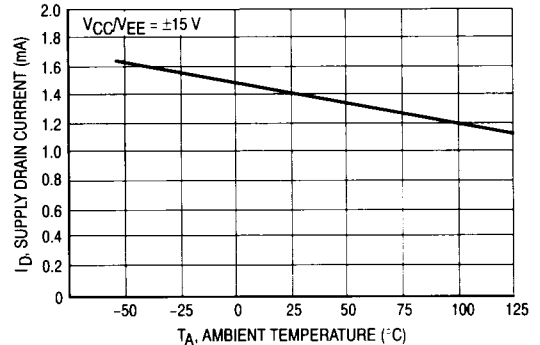

Figure 6. Supply Current per Amplifier versus Temperature



MC34001, MC35001, MC34002, MC35002, MC34004, MC35004

Figure 7. Large-Signal Voltage Gain and Phase Shift versus Frequency

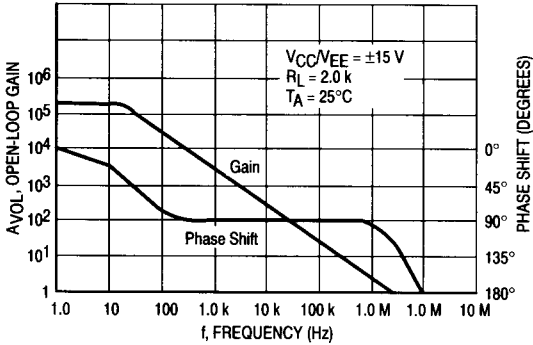
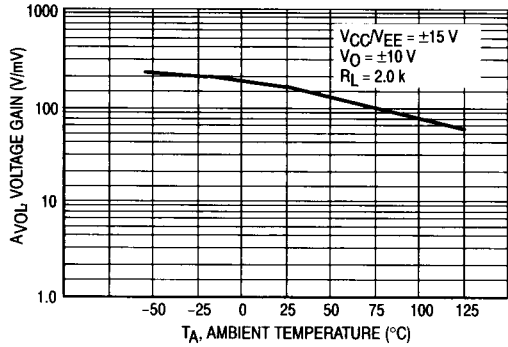

Figure 8. Large-Signal Voltage Gain versus Temperature



2

Figure 9. Normalized Slew Rate versus Temperature

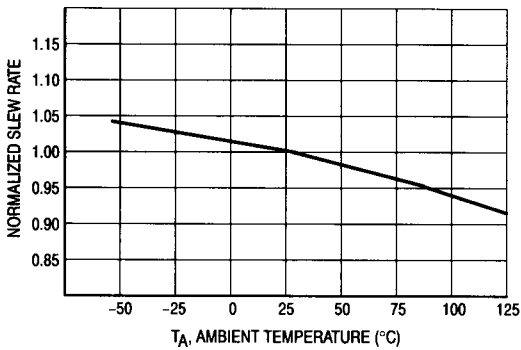

Figure 10. Equivalent Input Noise Voltage versus Frequency

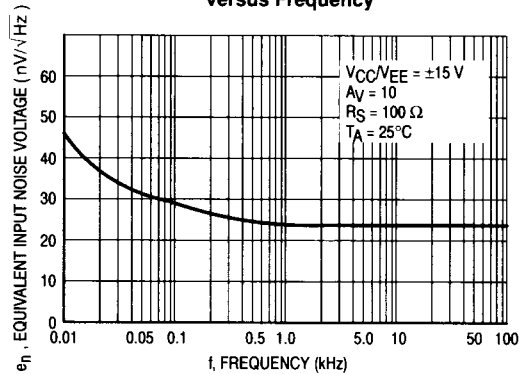
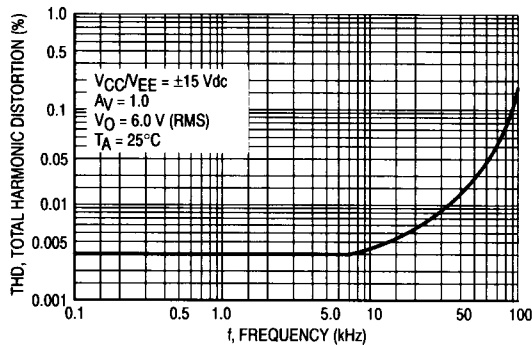

Figure 11. Total Harmonic Distortion versus Frequency



MC34001, MC35001, MC34002, MC35002, MC34004, MC35004

2

Representative Circuit Schematic
(Each Amplifier)

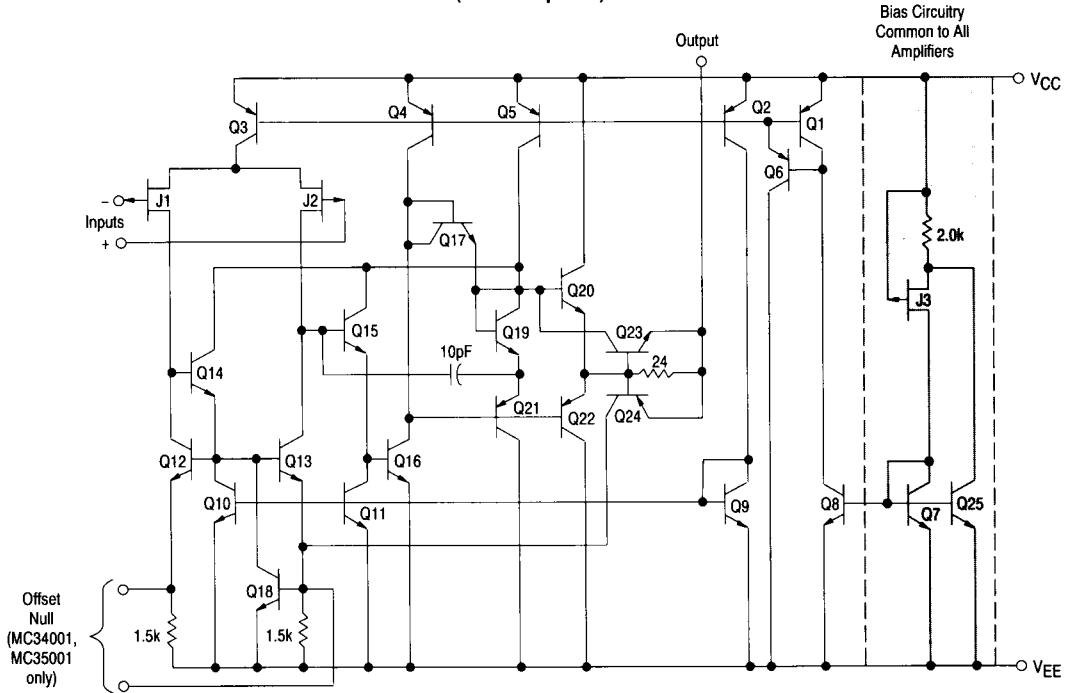
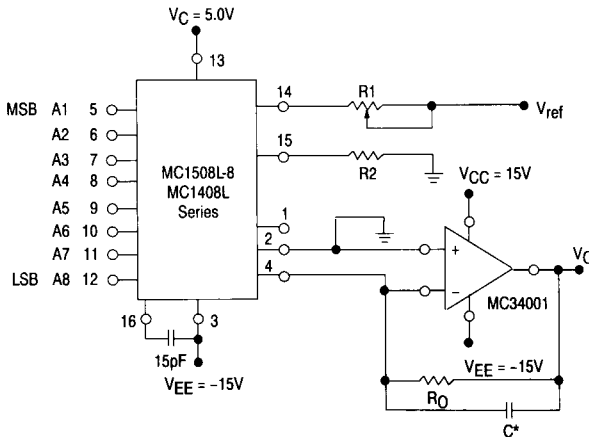

Figure 12. Output Current to Voltage Transformation for a D-to-A Converter



Settling time to within 1/2 LSB (± 19.5 mV) is approximately $4.0 \mu\text{s}$ from the time all bits are switched.

*The value of C may be selected to minimize overshoot and ringing ($C \approx 68$ pF)

Theoretical V_O

$$V_O = \frac{V_{ref}}{R_1} (R_O) \left[\frac{A_1}{2} + \frac{A_2}{4} + \frac{A_3}{8} + \frac{A_4}{16} + \frac{A_5}{32} + \frac{A_6}{64} + \frac{A_7}{128} + \frac{A_8}{256} \right]$$

Adjust V_{ref} , R_1 or R_O so that V_O with all digital inputs at high level is equal to 9.961 V.

$$V_{ref} = 2.0 \text{ Vdc}$$

$$R_1 = R_2 \approx 1.0 \text{ k}\Omega$$

$$R_O = 5.0 \text{ k}\Omega$$

$$V_O = \frac{2.0 \text{ V}}{1.0 \text{ k}} (5 \text{ k}) \left[\frac{1}{2} + \frac{1}{4} + \frac{1}{8} + \frac{1}{16} + \frac{1}{32} + \frac{1}{64} + \frac{1}{128} + \frac{1}{256} \right]$$

$$= 10 \text{ V} \left[\frac{255}{256} \right] = 9.961 \text{ V}$$

MC34001, MC35001, MC34002, MC35002, MC34004, MC35004

Figure 13. Positive Peak Detector

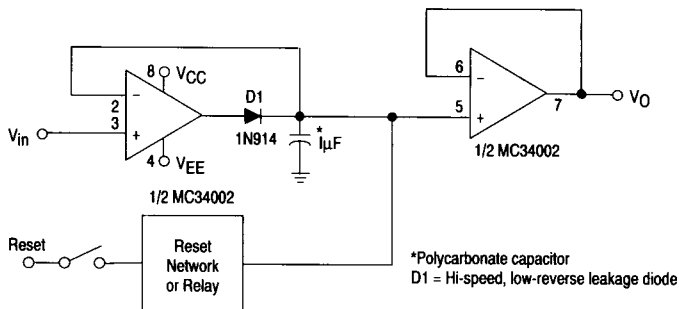
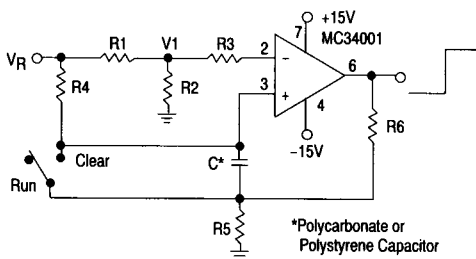

Figure 14. Long Interval RC Timer



Time (t) = R4 Cn (VR/VR-VI), R3 = R4, R5 = 0.1 R6
 If R1 = R2: t = 0.693 R4C

Design Example: 100 Second Timer

VR = 10 V C = 1.0 µF R3 = R4 = 144 M
 R6 = 20 k R5 = 2.0 k R1 = R2 = 1.0 k

Figure 15. Isolating Large Capacitive Loads

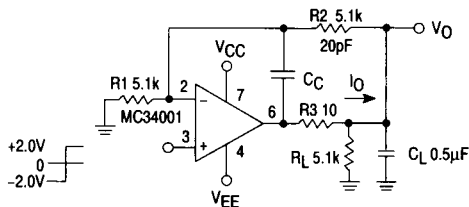

- Overshoot < 10%
- ts = 10 µs
- When driving large CL, the VO slew rate is determined by CL and IO(max):

$$\frac{\Delta V_O}{\Delta t} = \frac{I_O}{C_L} = \frac{0.02}{0.5} \text{ V}/\mu\text{s} = 0.04 \text{ V}/\mu\text{s} \text{ (with } C_L \text{ shown)}$$

Figure 16. Wide BW, Low Noise, Low Drift Amplifier

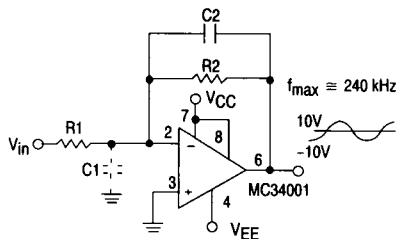

- Power BW: $f_{max} = \frac{S_r}{2\pi V_p} \cong 240 \text{ kHz}$
- Parasitic input capacitance (C1 ≅ 3.0 pF plus any additional layout capacitance) interacts with feedback elements and creates undesirable high-frequency pole. To compensate add C2 such that: R2C2 ≅ R1C1.