

Panasonic

三菱電機セミコンダクタ・アプリケーション
エンジニアリング株式会社

御中

2001年 8月22日

品名 セラミック発振子

I C品番 : M30622SAFP
発振子品番 : EFOS4194B (E) 5
品番 : EFOMC4194A (T) 4

(発 振 回 路 検 討 結 果)

ご使用機種

松下電子部品株式会社 LCRデバイスカンパニー
セラミックビジネスユニット

〒571-8506 大阪府門真市大字門真1006
電話 (大代表) 大阪(06)6908-1101

[目 次]

I	検討結果	2 ~ 4
II	測定回路	5
III	発振子の帰還量<Gain>による発振特性	
1.	オープンループゲイン	6
2.	発振電圧	6
3.	発振開始電圧・発振停止電圧	7
4.	発振立ち上がり時間	7
IV	オープン・ループ・ゲイン特性<L.G>	8
V	負荷容量依存性<C1=C2>	
1.	発振周波数	9
2.	発振電圧	9
3.	発振開始電圧・発振停止電圧	10
4.	発振立ち上がり時間	10
VI	電源電圧依存性<VDD>	
1.	発振周波数	11
2.	発振電圧	11
3.	発振電圧波形	12 ~ 13
4.	発振立ち上がり時間	14
VII	温度依存性<Temp.>	
1.	発振周波数	15
2.	発振電圧	15
3.	発振開始電圧・発振停止電圧	16
4.	発振立ち上がり時間	16
VIII	発振周波数の相関	17
IX	負荷容量アンバランス依存性<C1=33pF 睫 C2=xxpF>	
1.	発振周波数	18
2.	発振電圧	18
3.	発振開始電圧・発振停止電圧	19
4.	発振立ち上がり時間	19
X	負荷容量アンバランス依存性<C1=xxpF C2=33pF 睫>	
1.	発振周波数	20
2.	発振電圧	20
3.	発振開始電圧・発振停止電圧	21
4.	発振立ち上がり時間	21

マイコン / セラミック発振子 発振回路検討結果

I C (マイコン) 品番	M30622SAFP
適用セラミック発振子品番	EFOS4194B (E) 5 EFOMC4194A (T) 4
発振周波数	4.19MHz

松下電子部品株式会社
L C R デバイスカンパニー
セラミックビジネスユニット
圧電部品部 技術課



		測定条件							判定値	測定値	判定	備考							
		負荷容量 C1=C	電源電圧 VDD	帰還抵抗 Rf	制限抵抗 Rd	温度 Temp	発振レベル Gain	I C レベル											
発振子の帰還量による発振特性	基本波 (33pF)	33pF (内蔵)	5.0V	IC内蔵	---	常温	Typ. Max.	---	10.0dB以上	21.8dB~ 25.3dB	OK	判読範囲: Typ. ~ Max.							
	3次高調波 (33pF)								---dB以下	-1.1dB~ -1.8dB	---								
	発振電圧								入力側	5.0V	IC内蔵		---	常温	Typ. Max.	---	VI-Hi ≥ 3.50V VI-Lo ≤ 1.50V	4.24~4.84V -0.4~-0.04V	OK OK
									出力側								VO-Hi ≥ 3.50V VO-Lo ≤ 1.50V	4.84~5.00V -0.1~-0.2V	OK OK
	発振開始電圧								---	---	---		---	---	---	---	2.20V 以下	1.59V~ 1.72V	OK
	発振停止電圧								---	---	---		---	---	---	---	---	1.22V~ 1.41V	---
	発振立ち上がり時間								---	5.0V	---		---	---	---	---	---	60μs~ 68μs	---
ゲイン特性	基本波 (33pF)	33pF (内蔵)	5.0V	IC内蔵	---	常温	Typ.	---	10.0dB以上	22.21dB	OK								
	3次高調波 (33pF)								---dB以下	-0.99dB	---								
負荷容量の変化による発振特性	発振周波数 (33pFを基準とする)	22pF 27pF 33pF 39pF 47pF	5.0V	IC内蔵	---	常温	Typ.	---	---	+0.60% -0.55%	---	判読範囲: 22pF~47pF 負荷容量として C1=C2=33pFを基準とし、内蔵します。							
	発振電圧								入力側	5.0V	IC内蔵		---	常温	Typ.	---	VI-Hi ≥ 3.50V VI-Lo ≤ 1.50V	4.52~4.92V -0.2~-0.12V	OK OK
									出力側								VO-Hi ≥ 3.50V VO-Lo ≤ 1.50V	5.32~5.36V -0.2~-0.1V	OK OK
	発振開始電圧								---	---	---		---	---	---	---	2.20V 以下	1.68V~ 1.74V	
	発振停止電圧								---	---	---		---	---	---	---	---	1.34V~ 1.43V	---
	発振立ち上がり時間								---	5.0V	---		---	---	---	---	---	60μs~ 88μs	---

		測定条件						判定値	測定値	判定	備考			
		負荷容量	電源電圧 VDD	帰還抵抗 Rf	制限抵抗 Rd	温度 Temp	ゲイン Gain					I C サンプル Gain		
負荷容量の変化による発振特性	発振周波数 (33pFを標準とする)	C1= 33pF (酸)	5.0V	IC内蔵	---	常温	Typ.	---	-----	+0.59% -0.19%	---	範囲: 15pF~56pF		
	発振電圧	入力側							C2= 15pF	VI-Hi \geq 3.50V VI-Lo \leq 1.50V	3.48~5.88V -0.6~1.12V		OK	
		出力側							22pF 27pF 33pF	VO-Hi \geq 3.50V VO-Lo \leq 1.50V	5.08~5.36V -0.1~0.08V		OK OK	
	発振開始電圧								39pF 47pF 56pF	---	2.20V 納		1.68V~ 1.72V	OK
	発振停止電圧										-----		1.36V~ 1.41V	---
	発振立ち上がり時間									5.0V	-----		56 μ s~ 84 μ s	---
負荷容量の変化による発振特性	発振周波数 (33pFを標準とする)	C2= 33pF (酸)	5.0V	IC内蔵	---	常温	Typ.	---	-----	+0.95% -0.42%	---	範囲: 15pF~56pF		
	発振電圧	入力側							C1= 15pF	VI-Hi \geq 3.50V VI-Lo \leq 1.50V	4.00~5.88V -0.6~0.64V		OK OK	
		出力側							22pF 27pF 33pF	VO-Hi \geq 3.50V VO-Lo \leq 1.50V	5.12~5.44V -0.2~0.08V		OK OK	
	発振開始電圧								39pF 47pF 56pF	---	2.20V 納		1.70V~ 1.72V	OK
	発振停止電圧										-----		1.36V~ 1.50V	---
	発振立ち上がり時間									5.0V	-----		44 μ s~ 104 μ s	---

		測定条件							判定値	測定値	判定	備考		
		負荷容量 C1=C	電源電圧 VDD	帰還抵抗 Rf	制限抵抗 Rd	温度 Temp	増幅 ゲイン Gain	I C レベル						
電源電圧による発振特性	発振周波数 (5.0Vを基準とする)	33pF (内蔵)	2.0V 2.2V 3.0V 4.0V 5.0V 6.0V 6.5V	IC内蔵	----	常温	Typ.	----	±0.10%以内	+0.04% -0.10%	OK OK	特記: 2.2V-6.5V		
	発振電圧								入力側	VI-Hi ≥ 0.70VCC VI-Lo ≤ 0.30VCC	0.92VCC 0.01VCC		OK OK	
									出力側	VO-Hi ≥ 0.70VCC VO-Lo ≤ 0.30VCC	1.06VCC -0.02VCC		OK OK	
	発振立ち上がり時間								60μs~ 150μs		—			
温度の変化による発振特性	発振周波数 (+20℃を基準とする)	33pF (内蔵)	5.0V	IC内蔵	----	-40℃ -20℃ 0℃ 20℃ 40℃ 60℃ 80℃ 100℃ 120℃	Typ.	----	±0.50%以内	+0.05% -0.20%	OK OK	特記: -40℃ ~ +120℃		
	発振電圧								入力側	VI-Hi ≥ 3.50V VI-Lo ≤ 1.50V	4.50~4.90V -0.1~0.20V		OK OK	
									出力側	VO-Hi ≥ 3.50V VO-Lo ≤ 1.50V	5.15~5.35V -0.1~0.05V		OK OK	
	発振開始電圧								2.20V 以下		1.61V~ 1.83V		OK	
	発振停止電圧								—		1.38V~ 1.52V		—	
	発振立ち上がり時間								5.0V		36μs~ 104μs		—	
発振周波数の相関		33pF (内蔵)	5.0V	IC内蔵	----	常温	n=10	----	発振周波数は標準回路と比較し +14.71kHz になり 平均で約 +0.351% 高くなります。					

[結論]

以上の検討結果により、安定な発振特性が得られ特に問題無しと判断し、下記の回路定数を推奨します。
発振周波数は弊社標準回路と比べ平均で約 + 0.351% ずれますので、周波数公差につきましては御確認ください。

・推奨回路定数

回路定数	
内蔵負荷容量 (C1=C2)	33 pF
帰還抵抗 (Rf)	IC内蔵
制限抵抗 (Rd)	不要

注1 上記データは入手したマイコン、ついでの特撮結果です。

Test Circuit 1

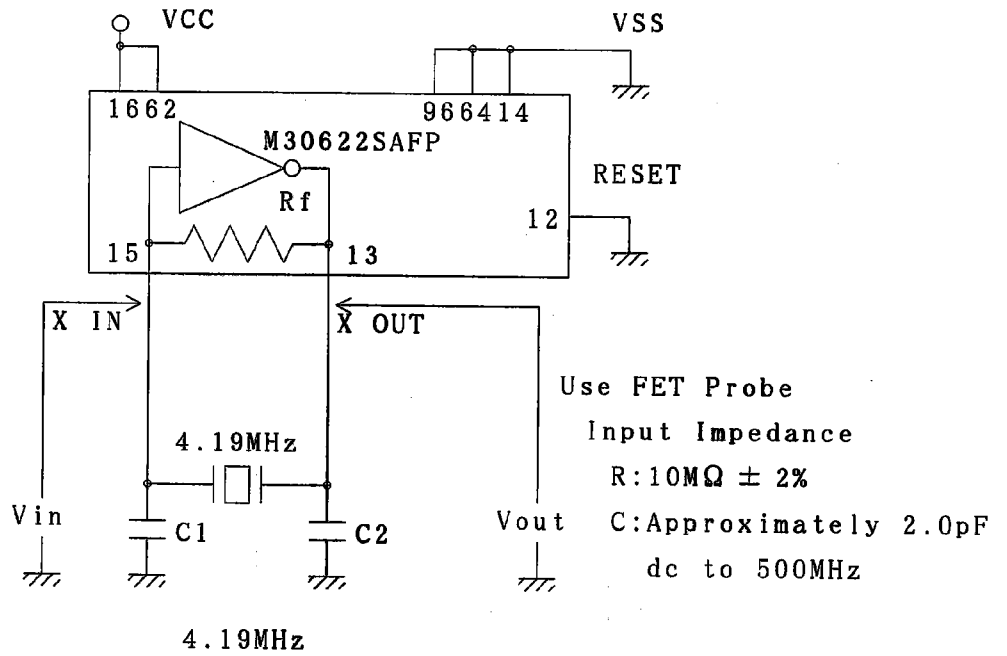

Test Circuit 2 (LOOP GAIN)

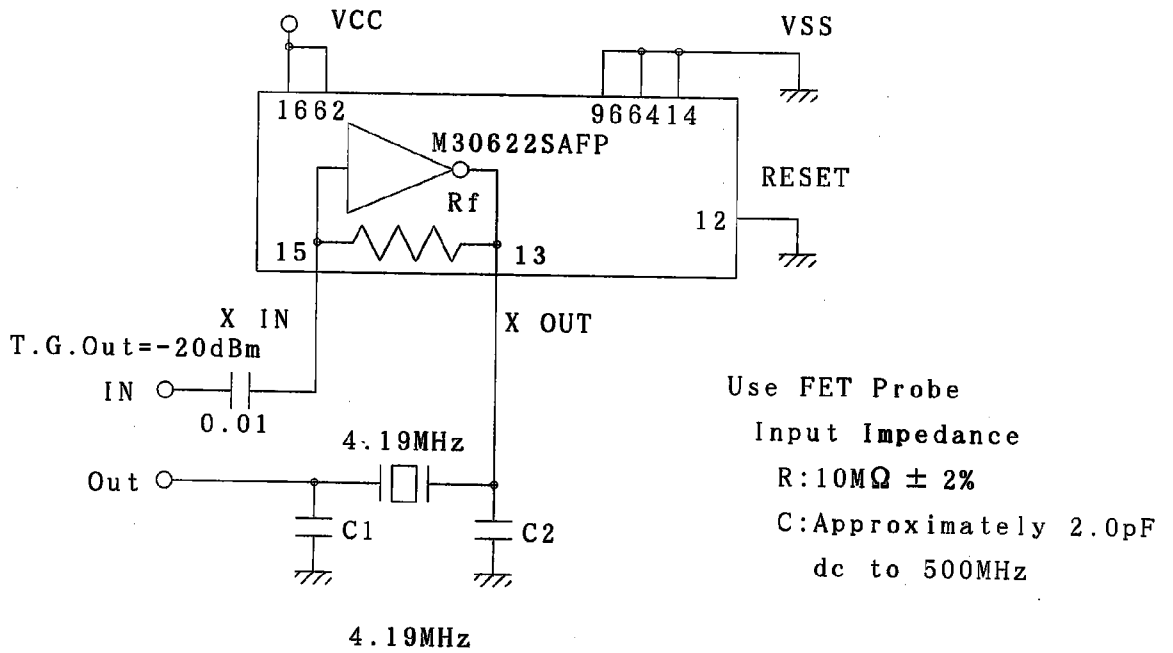

Open Loop Gain <L.G> v.s. Resonator Characteristics

I C : M30622SAFP VCC= + 5.0V C1= 33pF
 Resonator : 4.19MHz C2= 33pF
 ○——○ Gf
 △----△ G3f

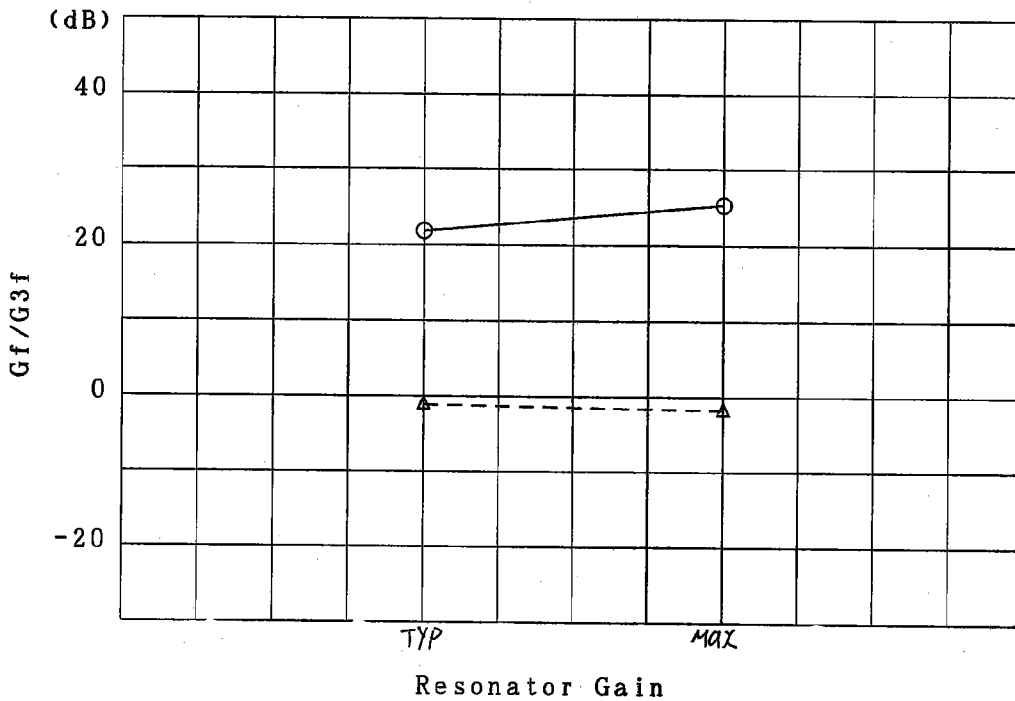

Fund.	3rd
21.8	-1.1
25.3	-1.8

Oscillating Voltage v.s. Resonator Characteristics

I C : M30622SAFP VCC= + 5.0V C1= 33pF
 Resonator : 4.19MHz C2= 33pF
 ○——○ Vin
 △----△ Vout

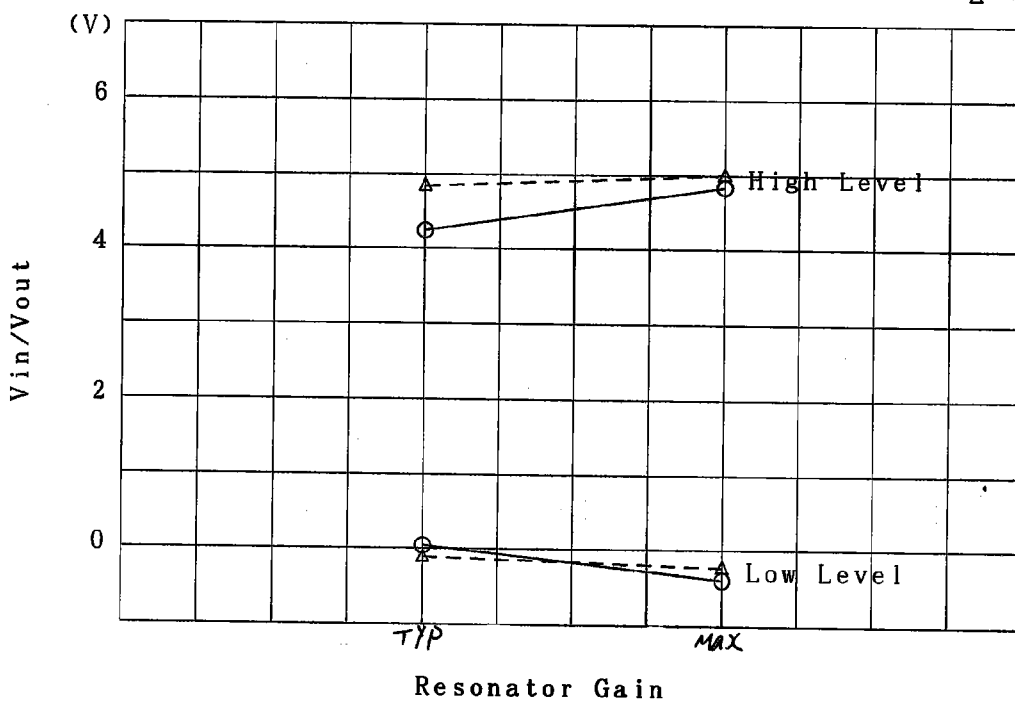

InHi	InLo	OutHi	OutLo
4.24	0.04	4.84	0.12
4.84	0.40	5.00	0.24

Oscillation Starting Voltage v.s. Resonator Characteristics

I C : M30622SAFP
 Resonator : 4.19MHz

C1 = 33pF
 C2 = 33pF

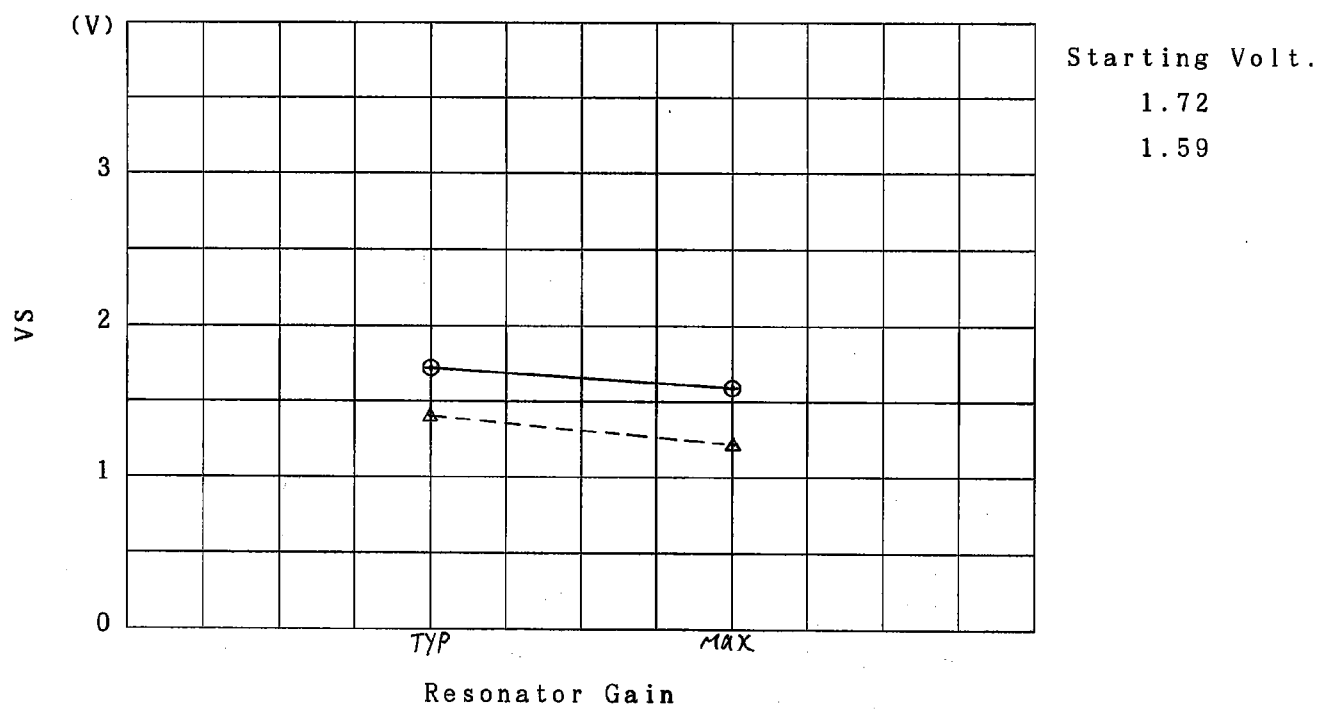

Oscillation Rising Time v.s. Resonator Characteristics

I C : M30622SAFP
 Resonator : 4.19MHz

VCC = + 5.0V

C1 = 33pF
 C2 = 33pF

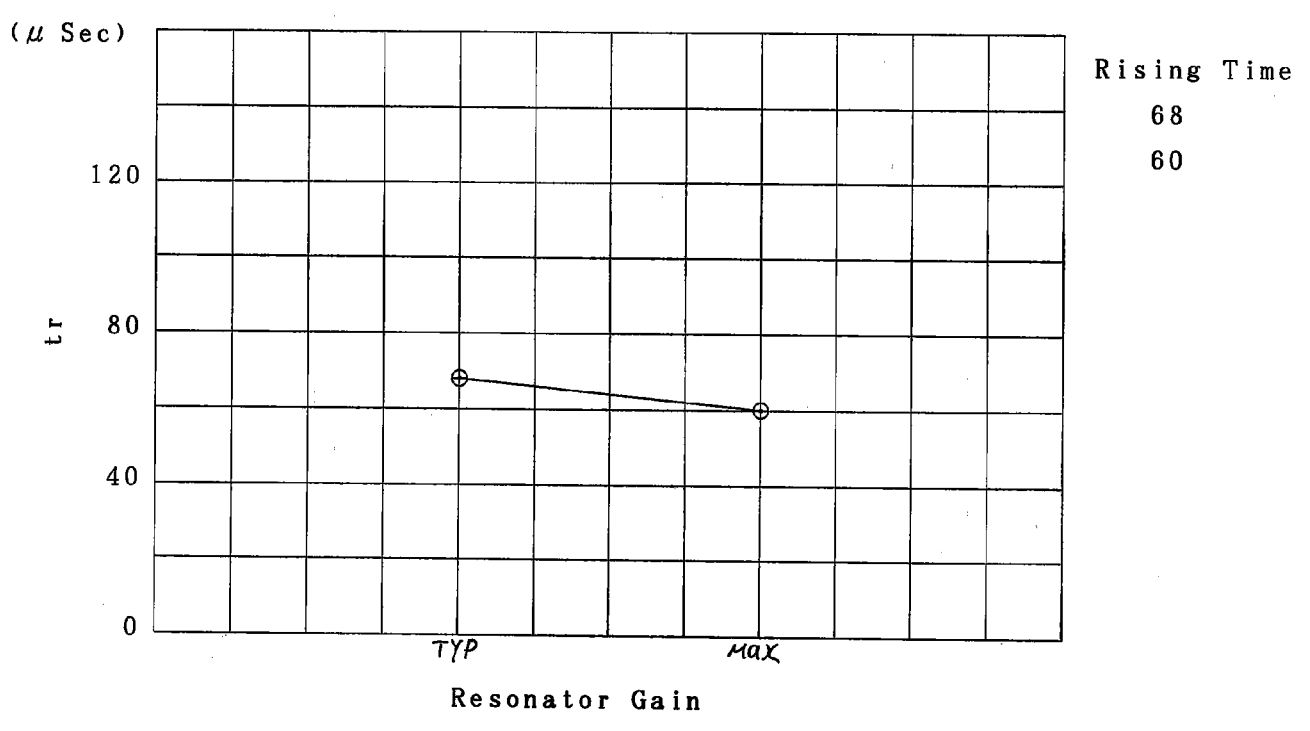

Open Loop Gain (Gain Characteristics of Circuit 2)

I C : M30622SAFP
 Resonator : 4.19MHz

VCC = + 5.0V

C1 = 33pF
 C2 = 33pF

1. Gain

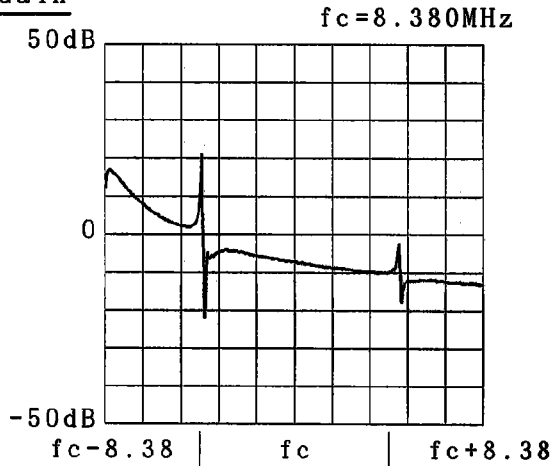

2. Gain/Phase

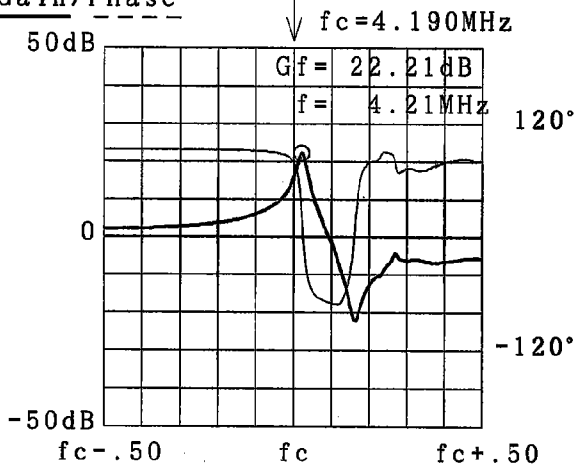

Fundamental Vibration Mode

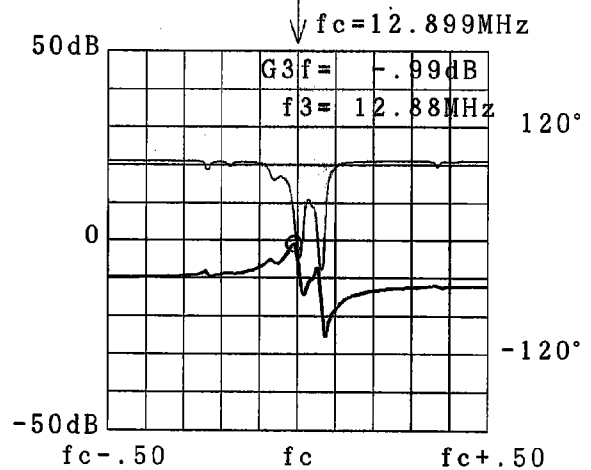

3rd Harmonic Over Tone Vibration Mode

Oscillating Frequency v.s. (C1,C2) Characteristics

I C : M30622SAFP VCC= + 5.0V
 Resonator : 4.19MHz

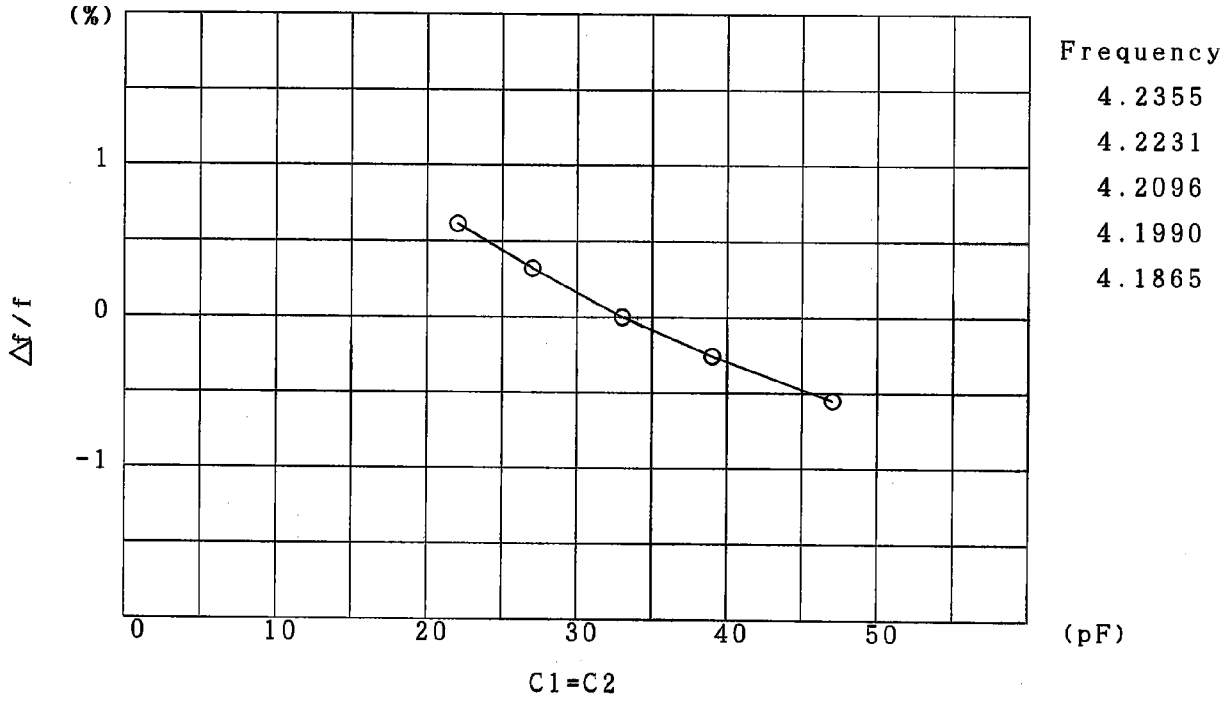

Frequency

4.2355
4.2231
4.2096
4.1990
4.1865

Oscillating Voltage v.s. (C1,C2) Characteristics

I C : M30622SAFP VCC= + 5.0V
 Resonator : 4.19MHz

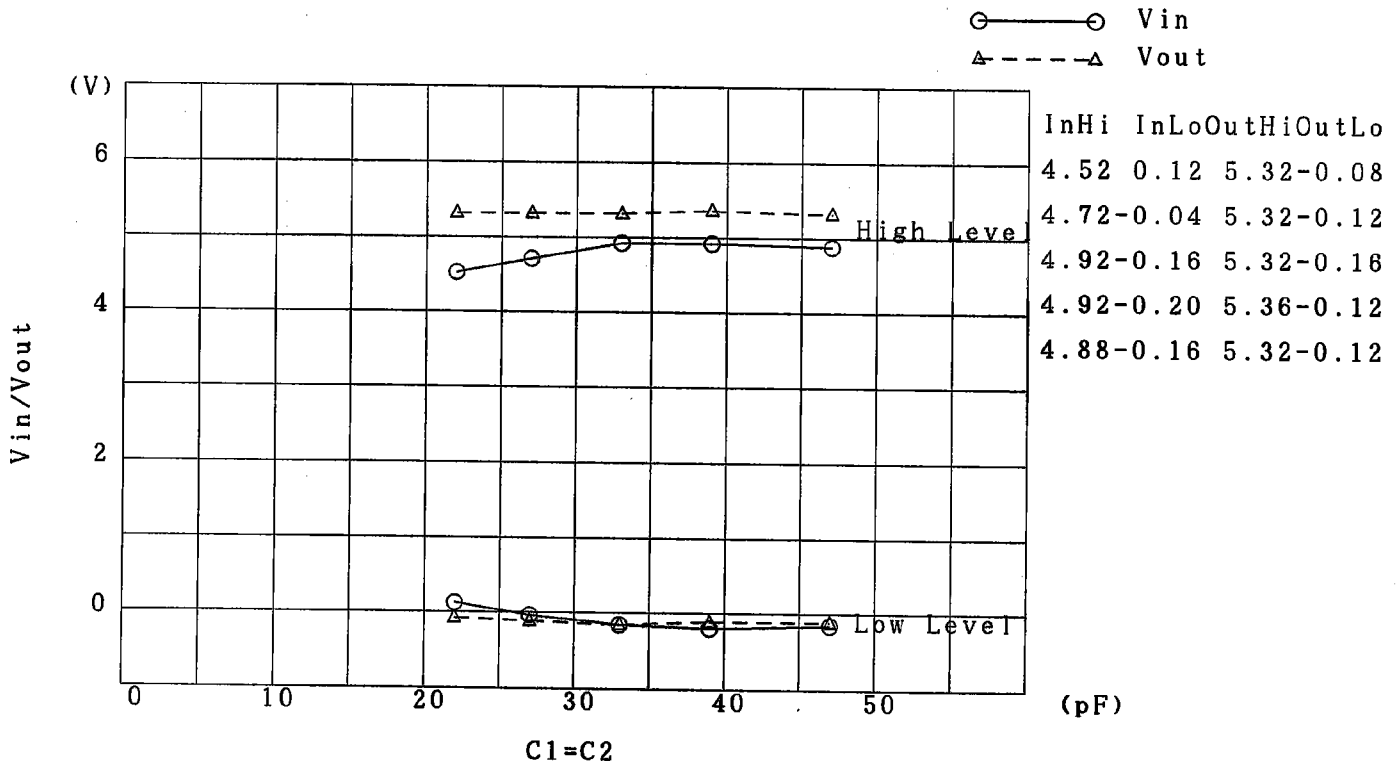

InHi	InLo	OutHi	OutLo
4.52	0.12	5.32	-0.08
4.72	-0.04	5.32	-0.12
4.92	-0.16	5.32	-0.16
4.92	-0.20	5.36	-0.12
4.88	-0.16	5.32	-0.12

Oscillation Starting Voltage v.s. (C1,C2) Characteristics

I C : M30622SAFP
 Resonator : 4.19MHz

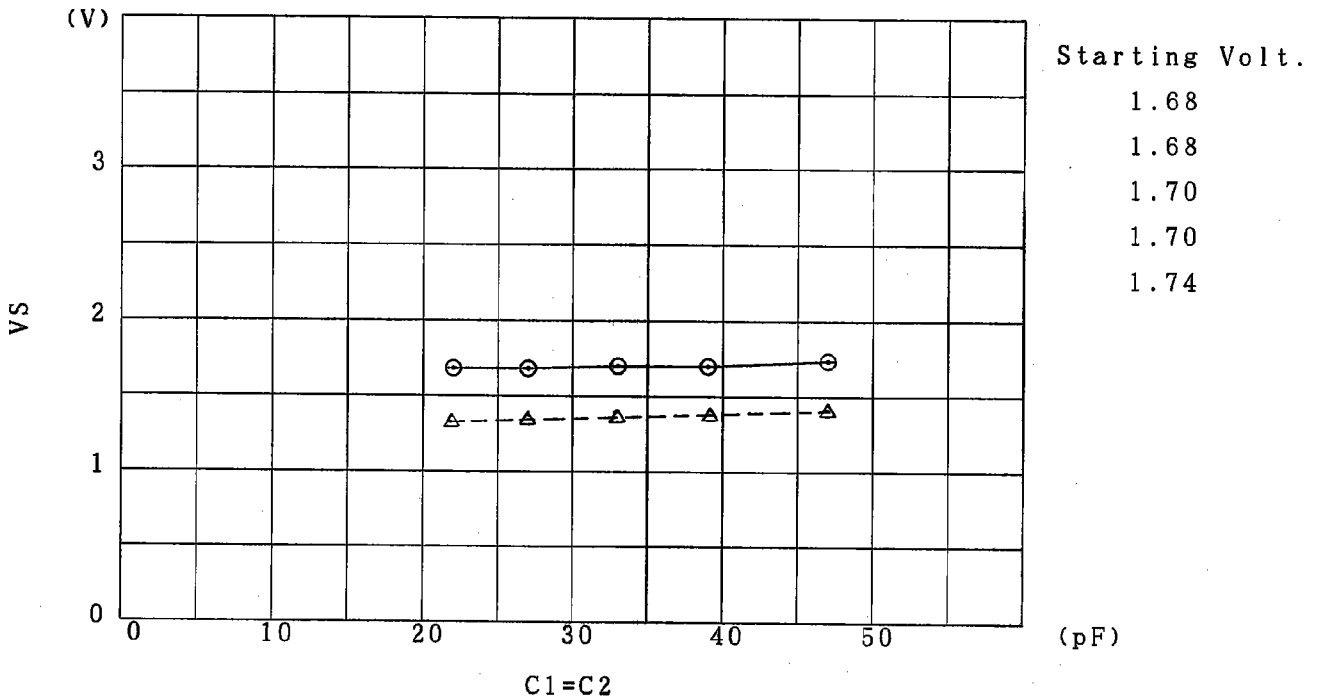

Oscillation Rising Time v.s. (C1,C2) Characteristics

I C : M30622SAFP VCC = + 5.0V
 Resonator : 4.19MHz

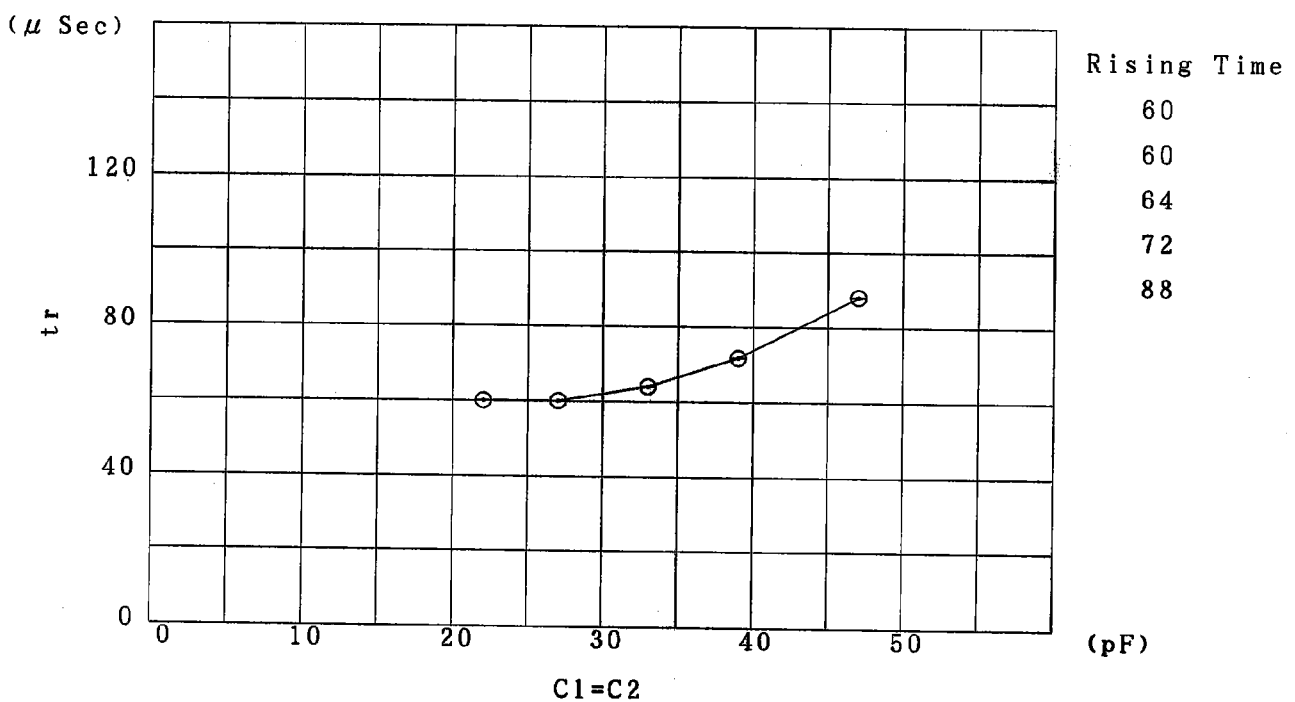

Oscillating Frequency v.s. VCC Characteristics

I C : M30622SAFP
 Resonator : 4.19MHz

C1 = 33pF
 C2 = 33pF

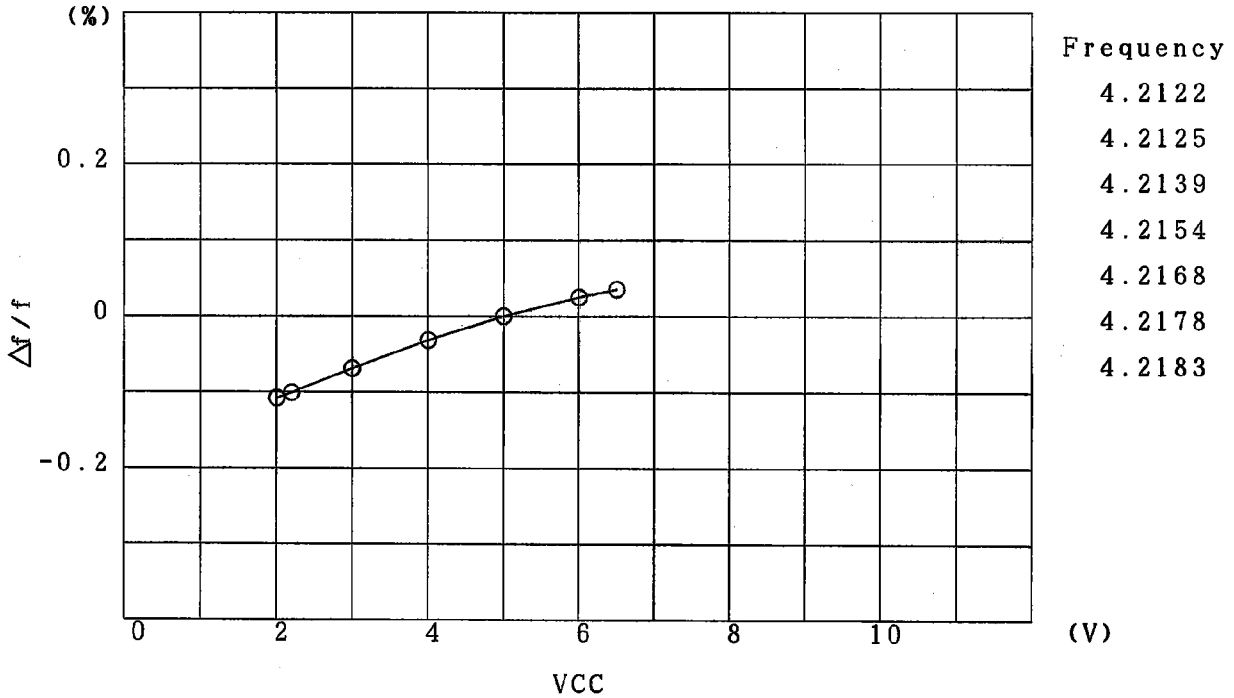

Oscillating Voltage v.s. VCC Characteristics

I C : M30622SAFP
 Resonator : 4.19MHz

C1 = 33pF
 C2 = 33pF

○ ——— ○ Vin
 △ ——— △ Vout

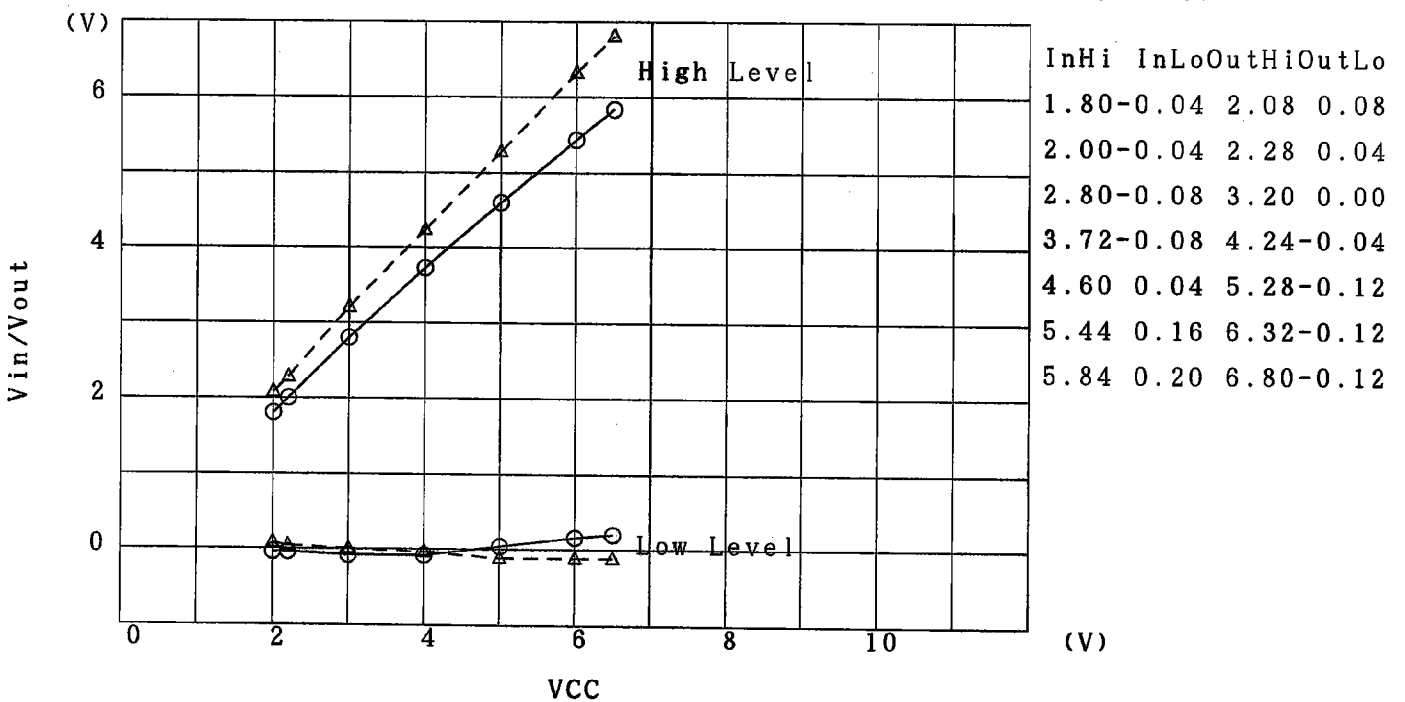

Oscillating Wave Form v.s. VCC Characteristics

I C : M30622SAFP
 Resonator : 4.19MHz

C1 = 33pF
 C2 = 33pF

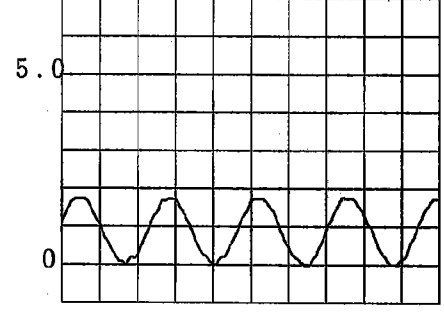
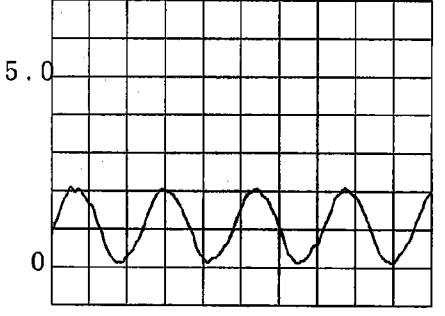
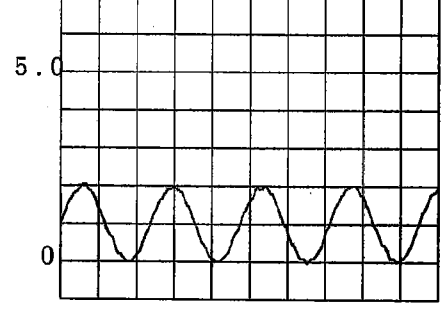
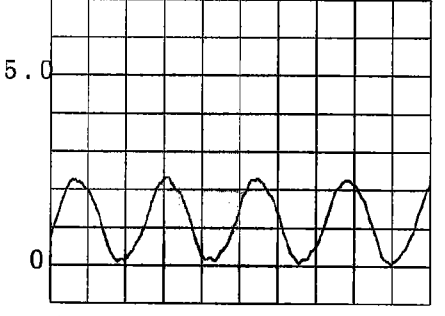
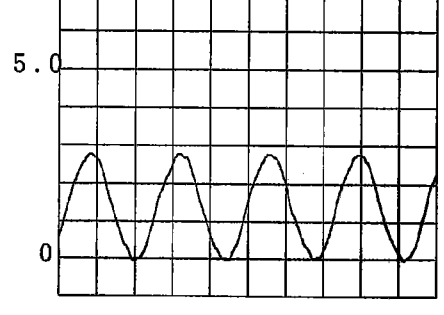
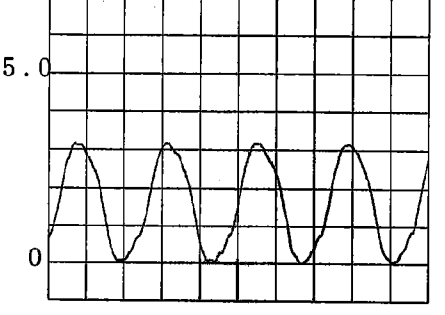
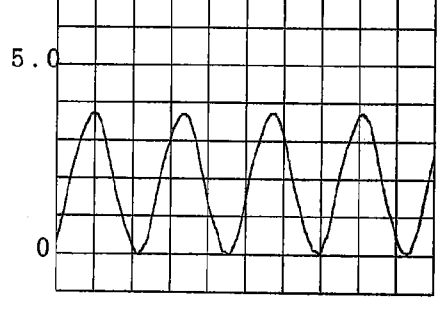
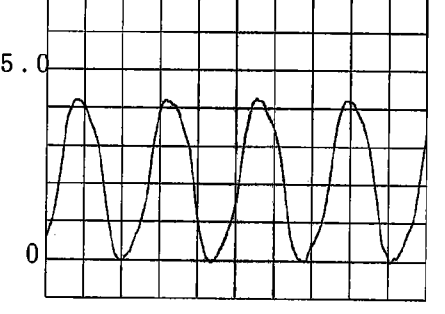
VCC	Vin	Vout
2V		
2.2V		
3V		
4V		

V = 1 (V/Div)
 H = 0.1 (u Sec/Div)

Oscillating Wave Form v.s. VCC Characteristics

I C : M30622SAFP
 Resonator : 4.19MHz

C1 = 33pF
 C2 = 33pF

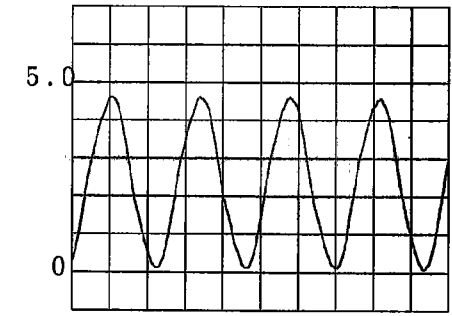
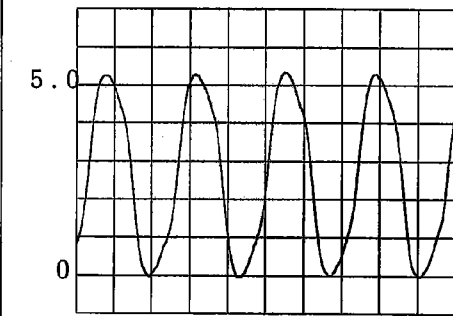
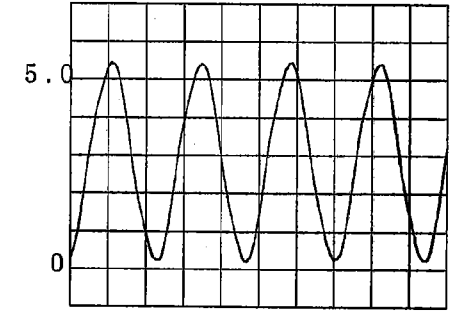
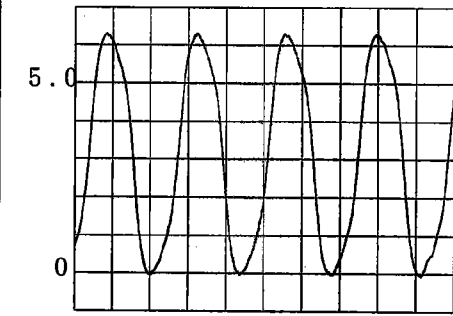
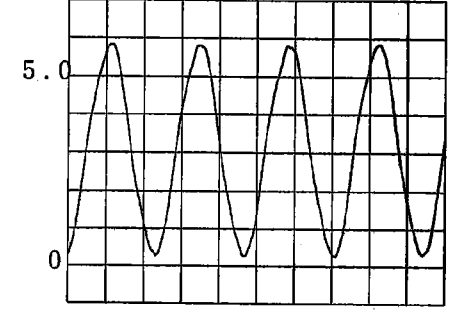
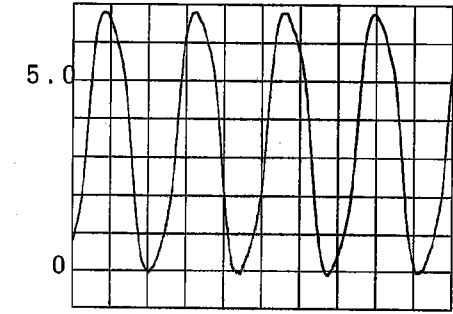
VCC	Vin	Vout
5V		
6V		
6.5V		

V = 1 (V/Div)
 H = 0.1 (u Sec/Div)

Oscillation Rising Time v.s. VCC Characteristics

I C : M30622SAFP
Resonator : 4.19MHz

C1 = 33pF
C2 = 33pF

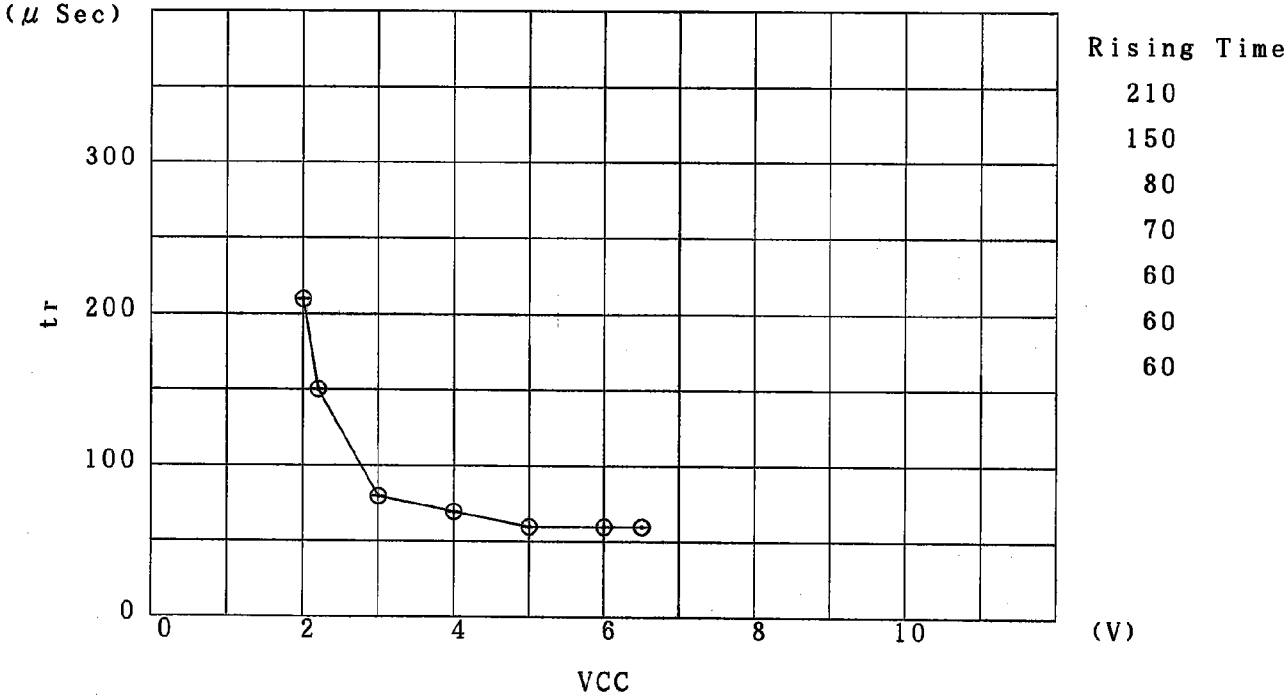

Temperature Characteristics of Oscillating Frequency

I C : M30622SAFP VCC = + 5.0V C1 = 33pF
 Resonator : 4.19MHz C2 = 33pF

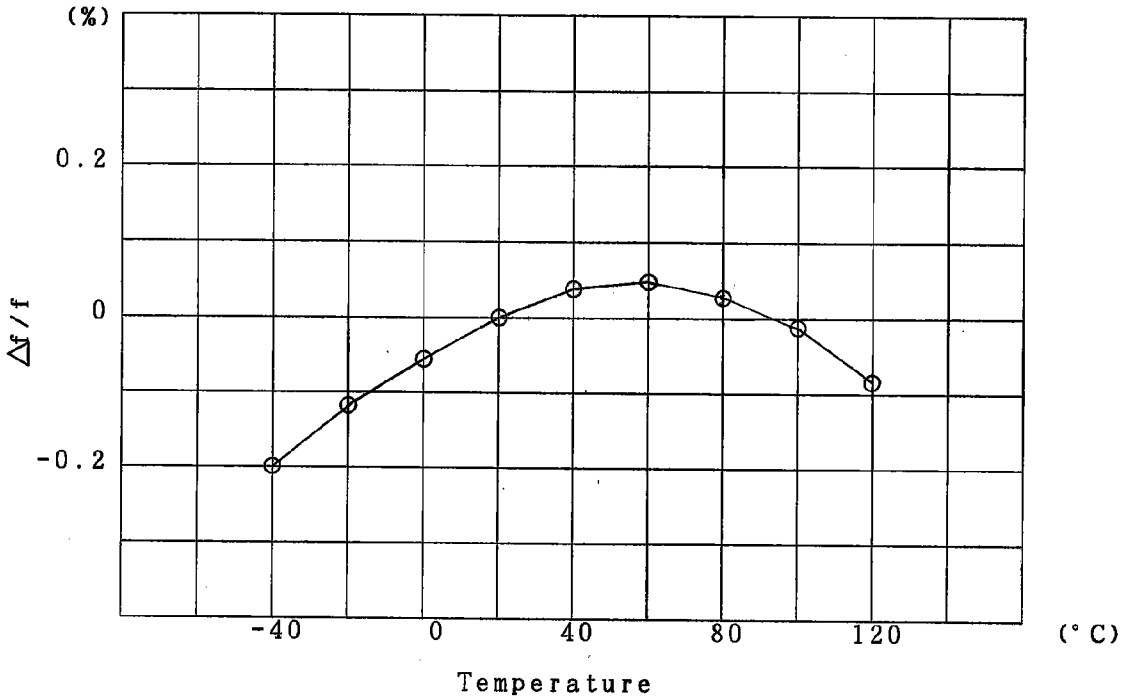

Temperature Characteristics of Oscillating Voltage

I C : M30622SAFP VCC = + 5.0V C1 = 33pF
 Resonator : 4.19MHz C2 = 33pF

○ ——— ○ Vin
 ▲ - - - - ▲ Vout

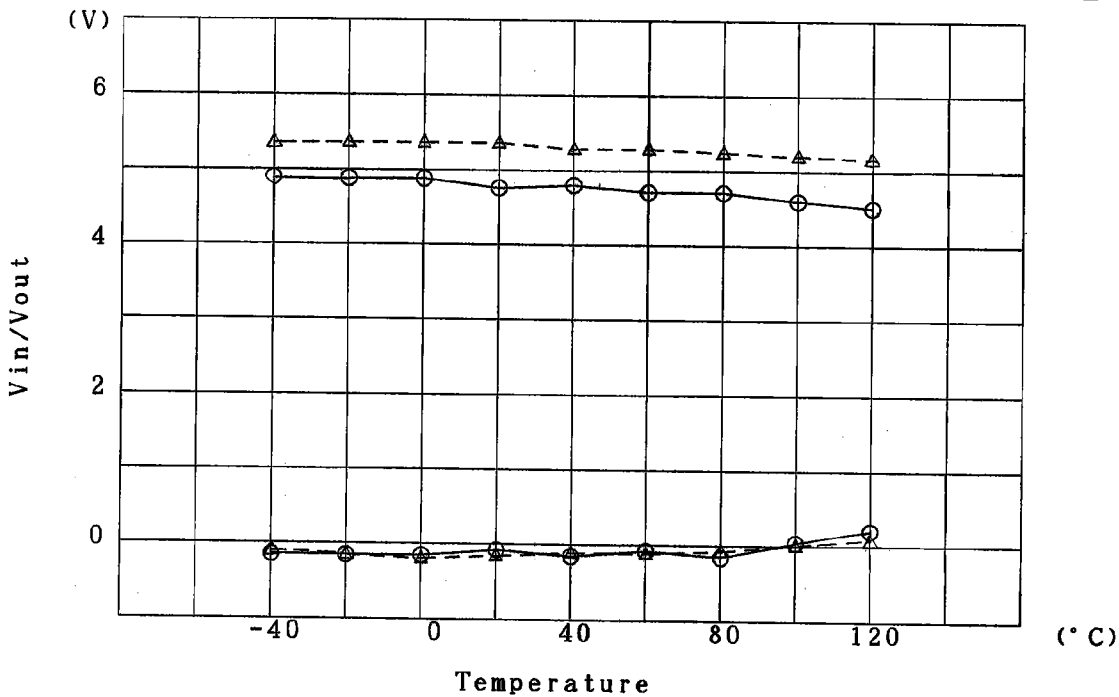

Temperature Characteristics of Oscillation Starting Voltage

I C : M30622SAFP
 Resonator : 4.19MHz

C1= 33pF
 C2= 33pF

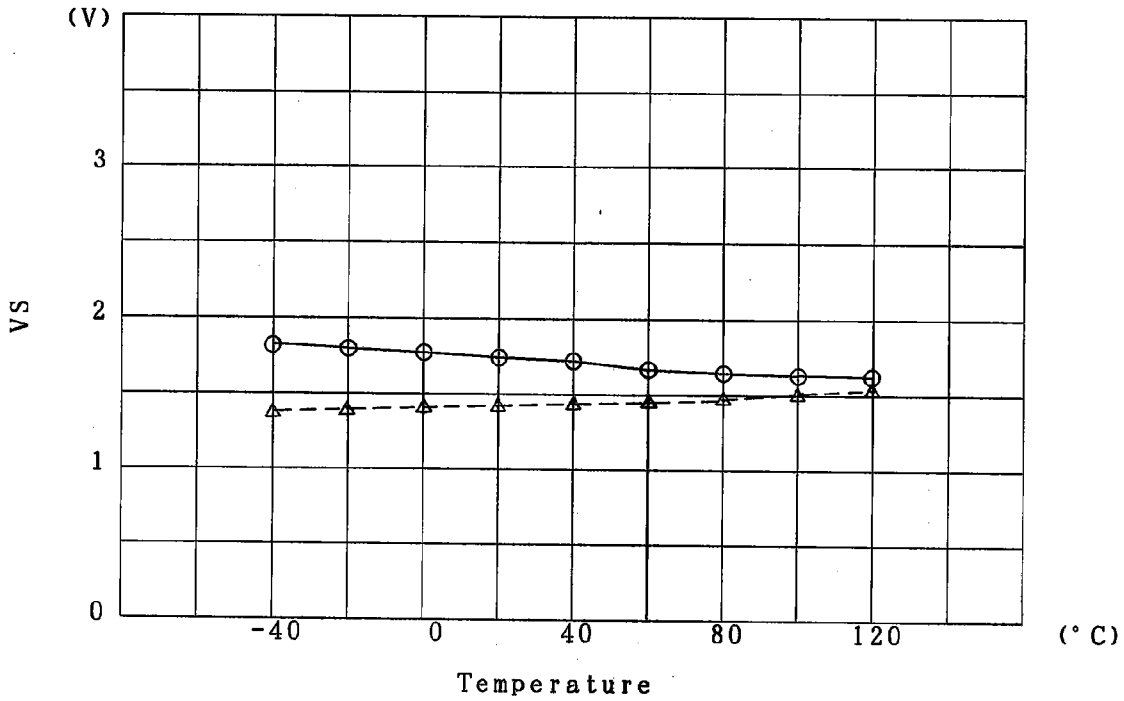

Temperature Characteristics of Oscillation Rising Time

I C : M30622SAFP
 Resonator : 4.19MHz

VCC= + 5.0V
 C1= 33pF
 C2= 33pF

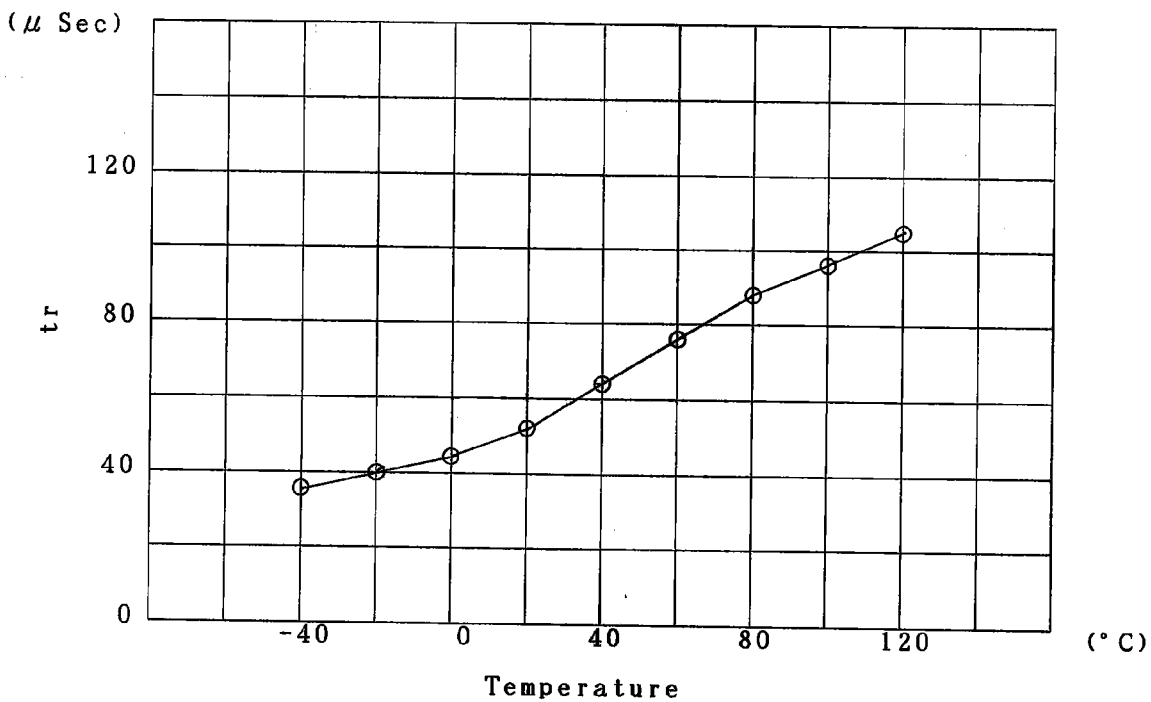

Oscillating Frequency Correlation of Circuit

I C : M30622SAFP
 Resonator : 4.19MHz

VCC= + 5.0V

C1= 33pF
 C2= 33pF

$f_c = 4.190\text{MHz}$

NO.	STD. (MHz)	TEST (MHz)	DEF. (KHz)
1	4.1871	4.2022	15.1
2	4.2017	4.2180	16.3
3	4.1919	4.2075	15.6
4	4.1982	4.2137	15.5
5	4.2023	4.2154	13.1
6	4.2053	4.2198	14.5
7	4.2077	4.2229	15.2
8	4.2028	4.2161	13.3
9	4.1968	4.2121	15.3
10	4.2006	4.2138	13.2

NO.	STD. (MHz)	TEST (MHz)	DEF. (KHz)
11			
12			
13			
14			
15			
16			
17			
18			
19			
20			

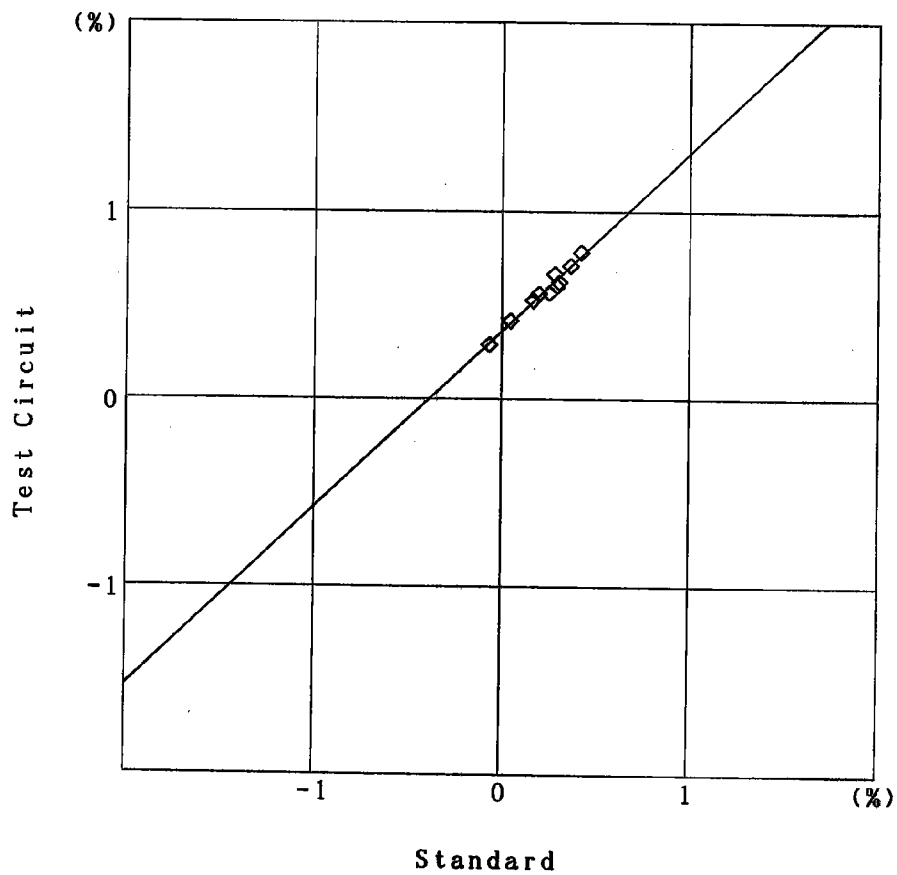

Oscillating Frequency v.s. (C2) Characteristics

I C : M30622SAFP VCC= + 5.0V C1= 33PF
 Resonator : 4.19MHz

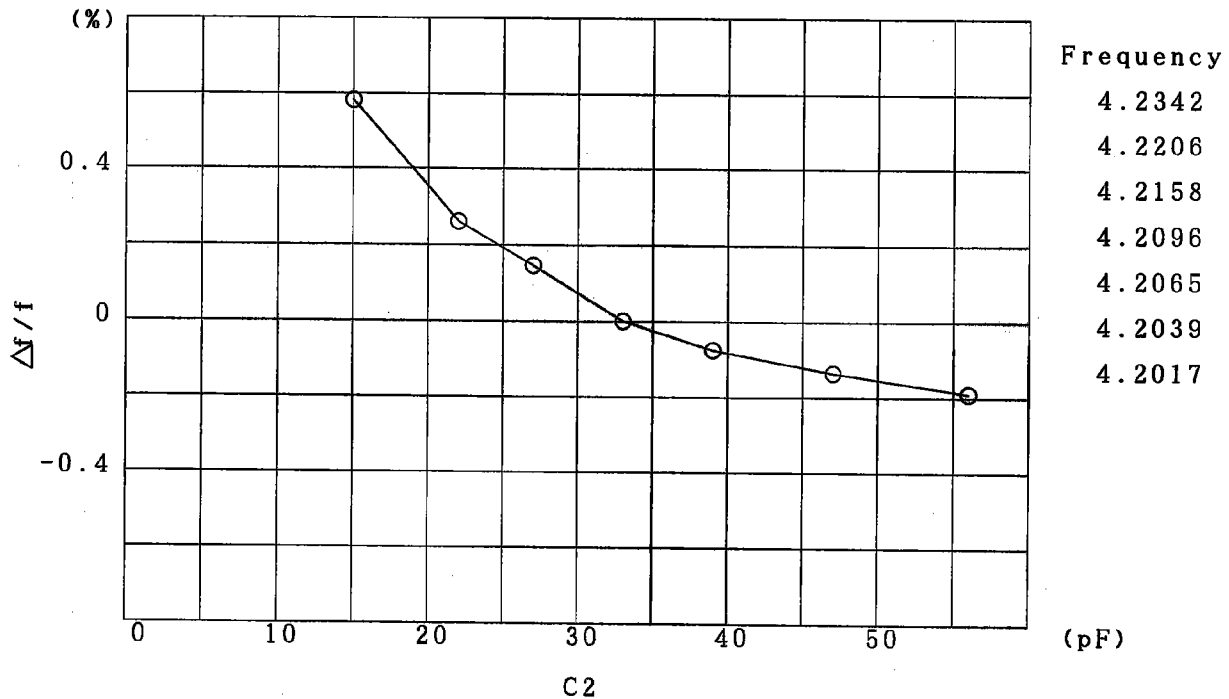

Oscillating Voltage v.s. (C2) Characteristics

I C : M30622SAFP VCC= + 5.0V C1= 33PF
 Resonator : 4.19MHz

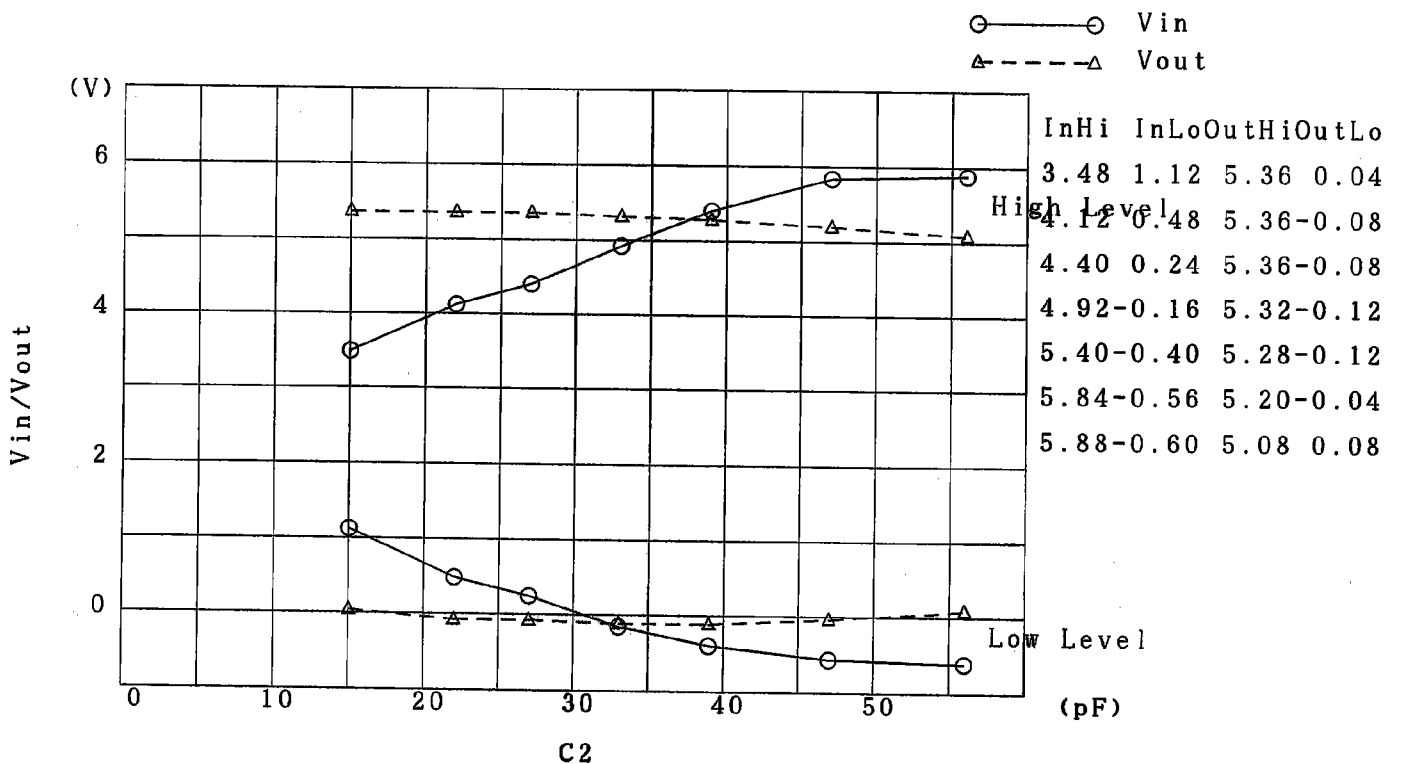

Oscillation Starting Voltage v.s. (C2) Characteristics

I C : M30622SAFP
Resonator : 4.19MHz

C1 = 33PF

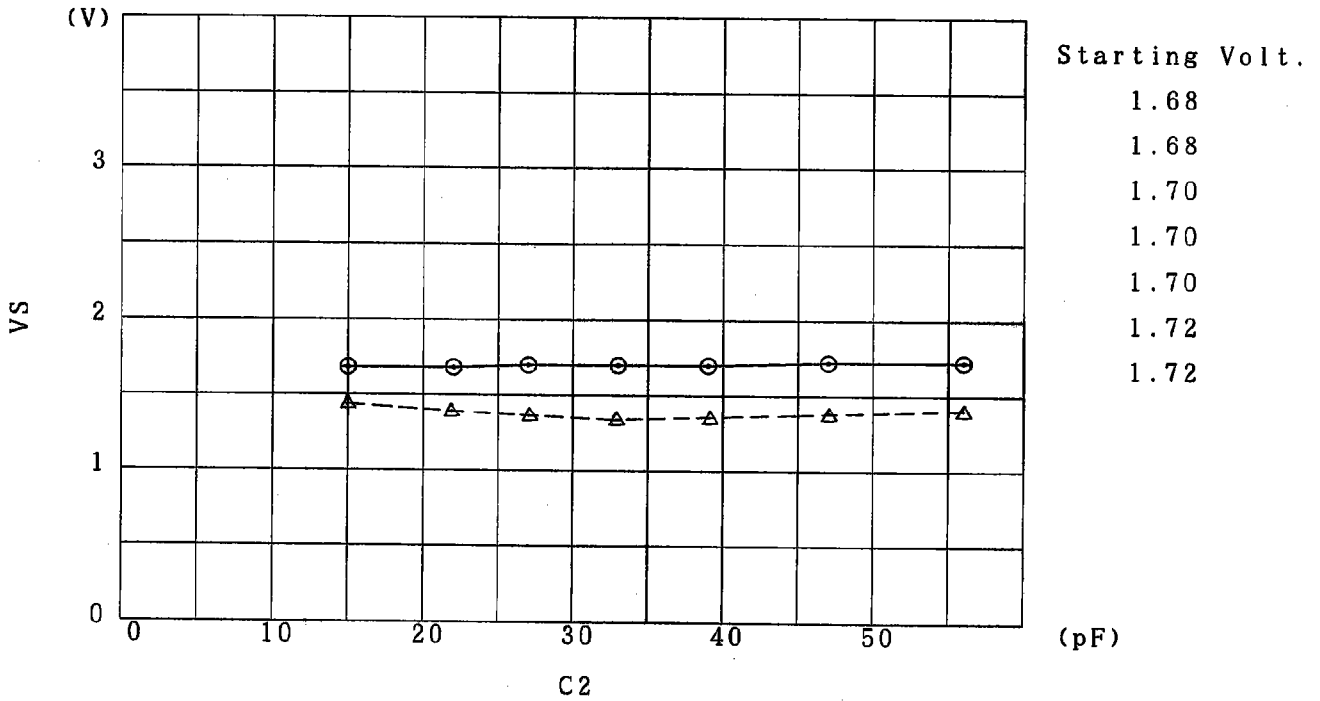

Oscillation Rising Time v.s. (C2) Characteristics

I C : M30622SAFP
Resonator : 4.19MHz

VCC = + 5.0V C1 = 33PF

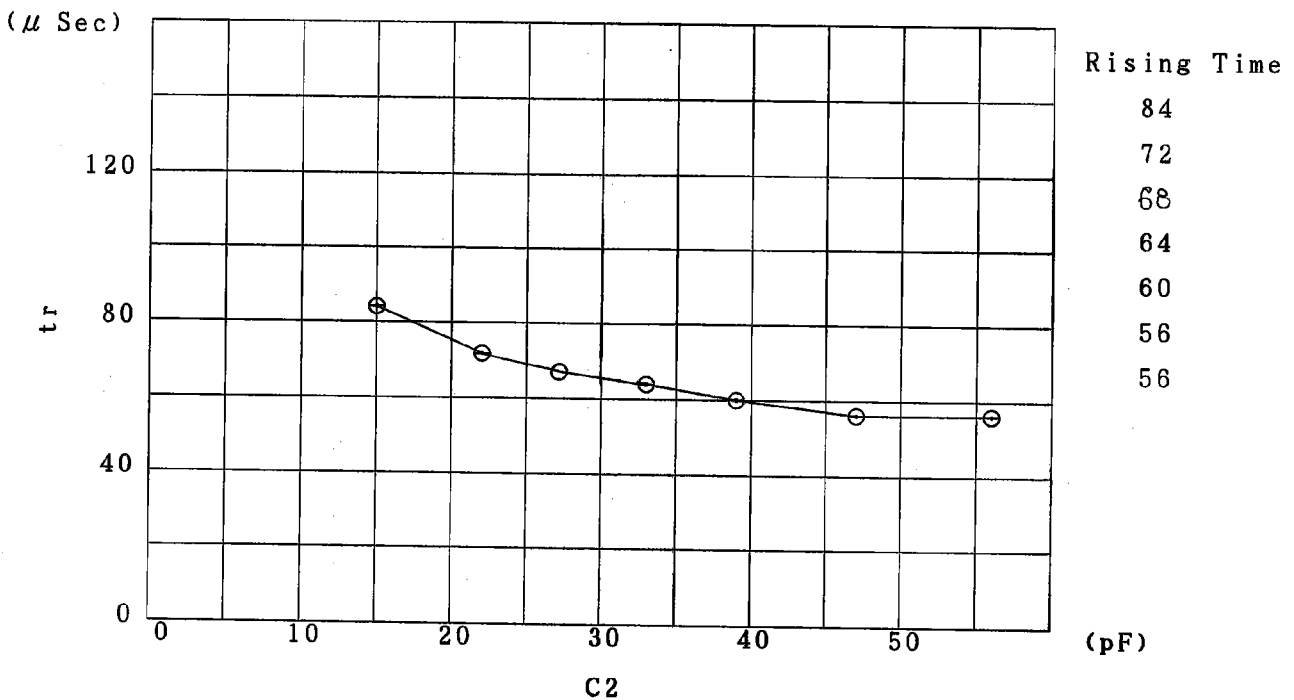

Oscillating Frequency v.s. (C1) Characteristics

I C : M30622SAFP VCC= + 5.0V
 Resonator : 4.19MHz C2= 33PF

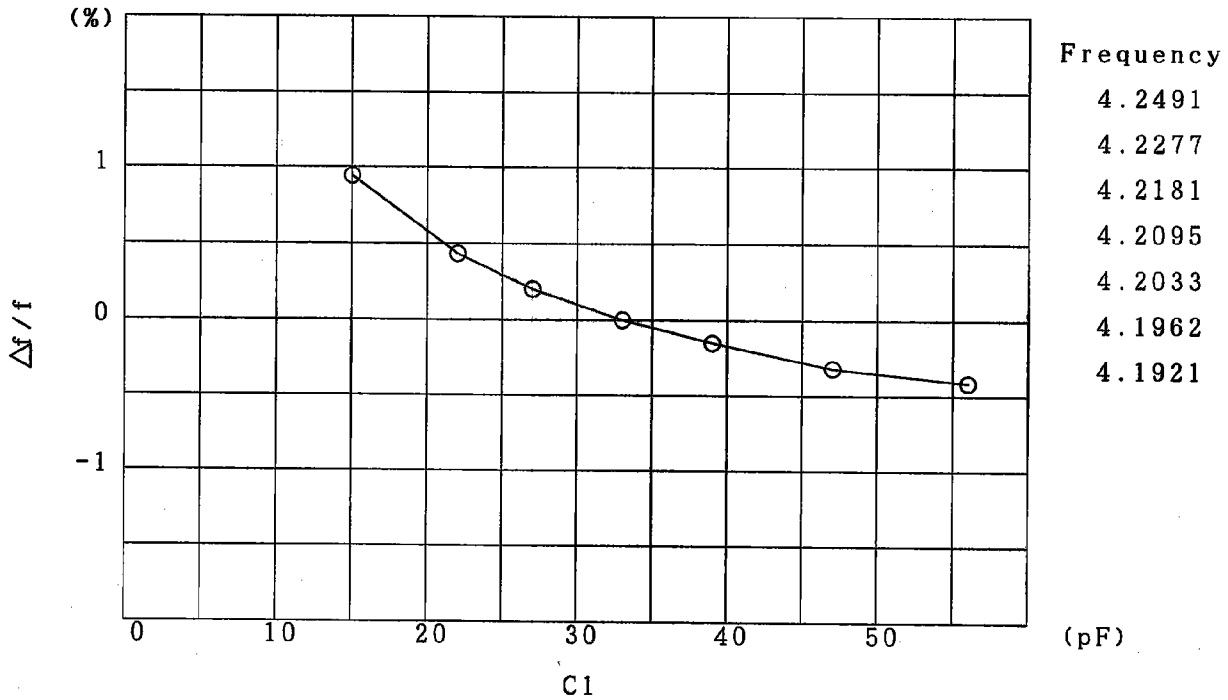

Oscillating Voltage v.s. (C1) Characteristics

I C : M30622SAFP VCC= + 5.0V
 Resonator : 4.19MHz C2= 33PF

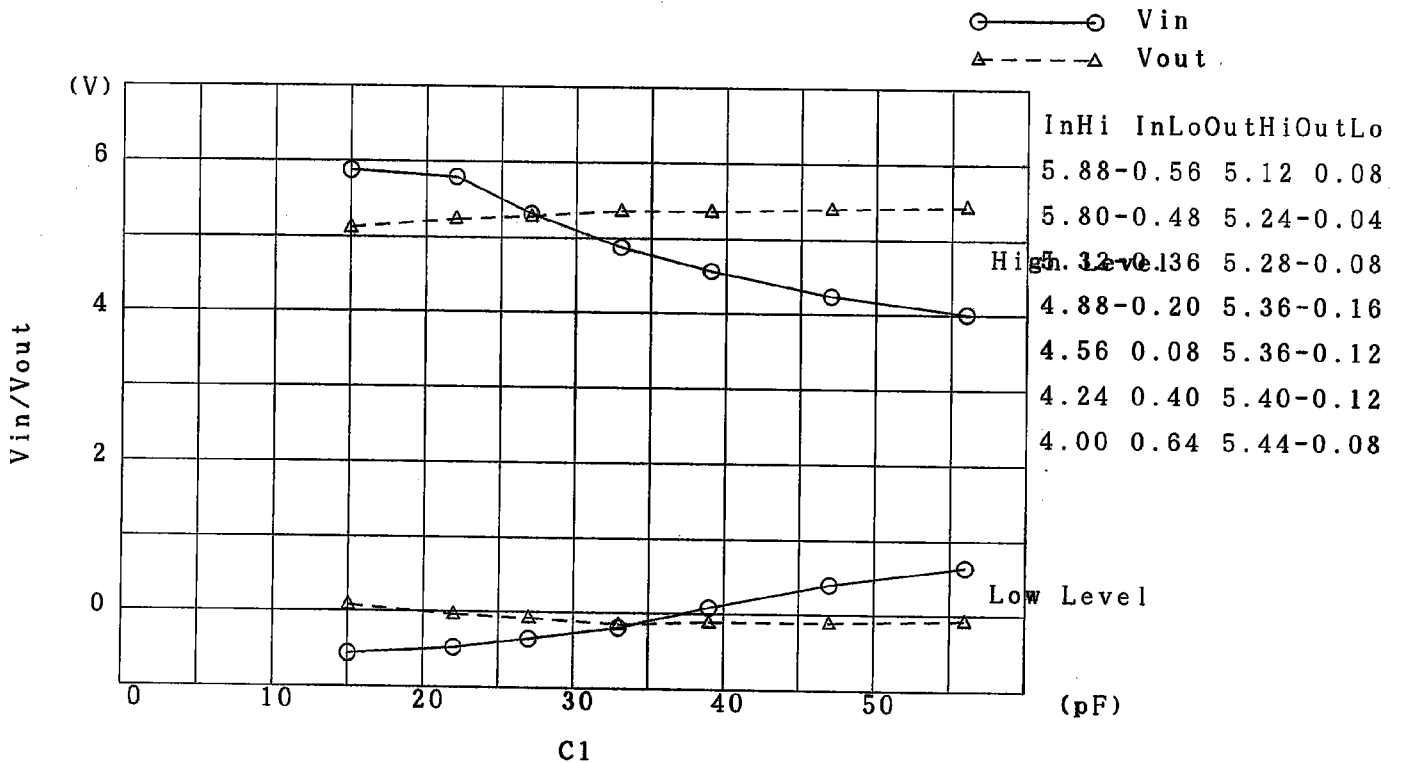

Oscillation Starting Voltage v.s. (C1) Characteristics

I C : M30622SAFP
 Resonator : 4.19MHz

C2 = 33PF

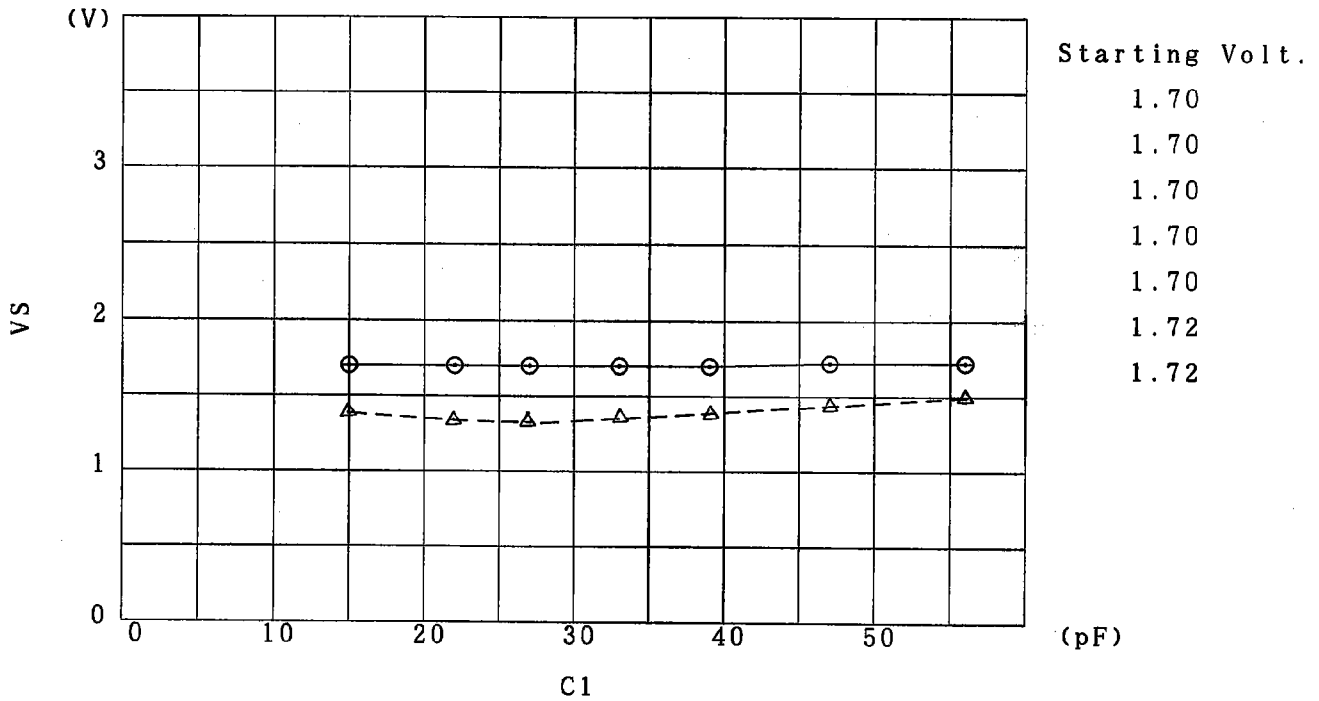

Oscillation Rising Time v.s. (C1) Characteristics

I C : M30622SAFP
 Resonator : 4.19MHz

VCC = + 5.0V

C2 = 33PF

