

MC44030 MC44035

Product Preview

Multistandard Video Signal Processor with Integrated Chroma Delay Line

The MC44030/35 is a highly advanced circuit which performs most of the basic functions required for a color TV. All its advanced features are under processor control via I²C bus, enabling potentiometer controls to be removed completely and allowing significant cost savings together with the possibility of implementing sophisticated automatic test routines.

A summary of the features available on the device is given below:

- Operation from a Single 5.0 V Supply; Low Current Consumption (Typically 150 mA)
- PAL/SECAM/NTSC Decoding Capability (4 Matrix Modes Available)
- Integrated Chroma Delay Line
- Dual Composite Video or S-VHS Inputs
- Integrated Luma and Chroma Filters (Including SECAM Cloche Filter)
- Programmable Luma Delay and Peaking
- RGB Drives Including CONTRAST/BRIGHTNESS Controls and Auto Grey-Scale
- External RGB and Fast Commutate Inputs with SATURATION Control Possibility
- Auxiliary Y, R-Y, B-Y Inputs
- Line Timebase Featuring H-PHASE Control and Switchable Phase Detector Gain
- Countdown Type Vertical Timebase Including the Vertical Geometry Corrections
- 16:9 Display Mode Capability
- E-W Parabola Drive Including the Horizontal Geometry Corrections
- Anode Current Monitor with Vertical Breathing Compensation
- Analog Contrast Control, Allowing Fast Beam Current Limitation
- Pin to Pin Compatible with MC44002/7
- MC44035 is the PAL/NTSC Only Version of the MC44030
- Available in DIP and TQFP Packages

MULTISTANDARD VIDEO SIGNAL PROCESSOR WITH INTEGRATED CHROMA DELAY LINE

SEMICONDUCTOR TECHNICAL DATA

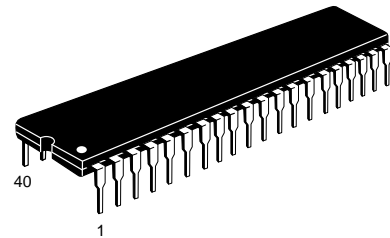

P SUFFIX
PLASTIC PACKAGE
CASE 711

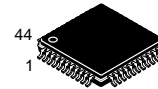

FTB SUFFIX
PLASTIC PACKAGE
CASE 824D
(TQFP-44)

ORDERING INFORMATION

Device	Operating Temperature Range	Package
MC44030P	T _A = 0° to +70°C	Plastic DIP
MC44030FTB		TQFP-44
MC44035P		Plastic DIP
MC44035FTB		TQFP-44

MC44030 MC44035

Simplified Block Diagram

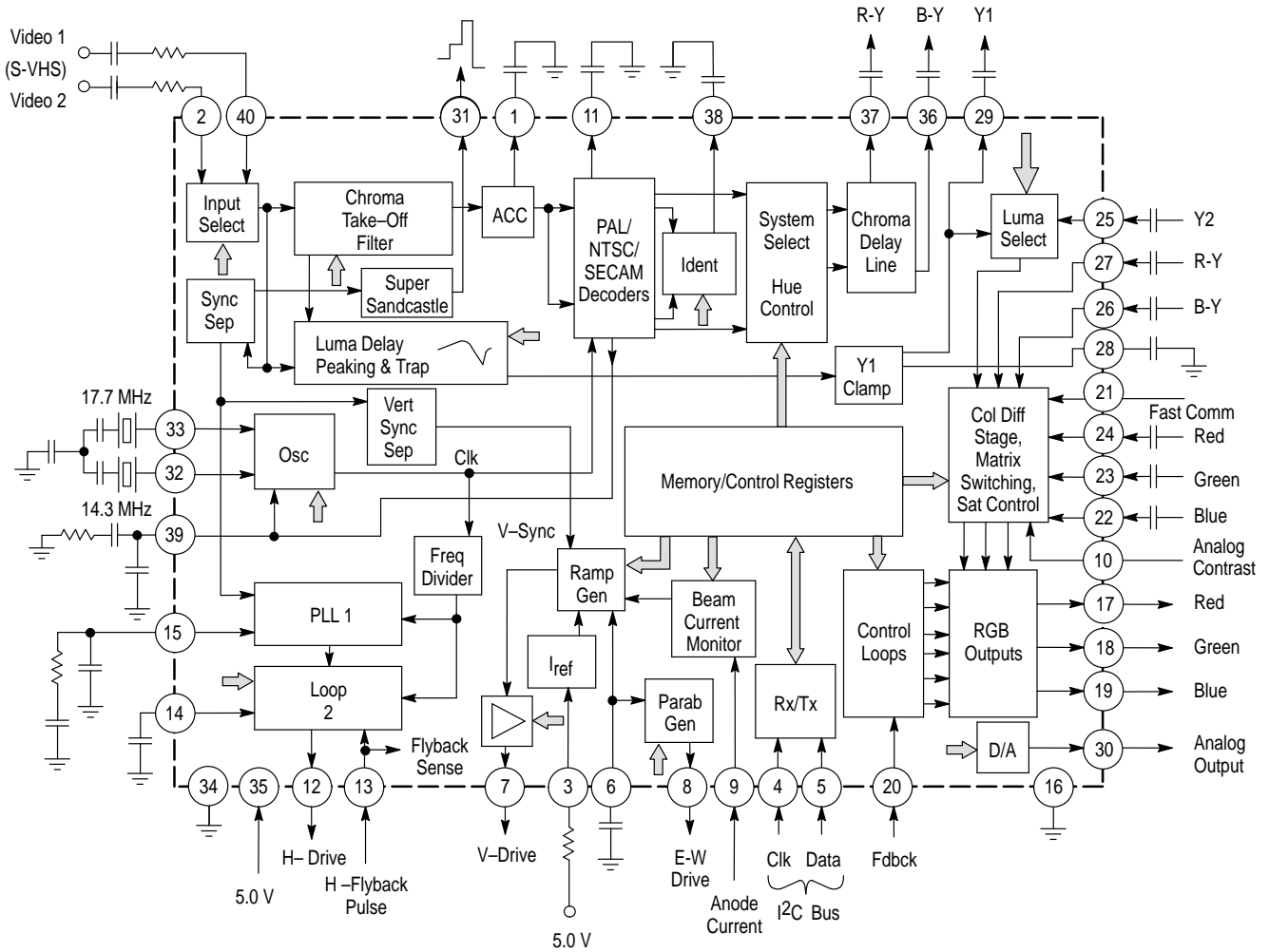

NOTE: Pin numbers shown are for the DIP package.

This device contains 6360 active transistors.

MC44030 MC44035

OUTLINE DIMENSIONS

P SUFFIX
PLASTIC PACKAGE
CASE 711-03
ISSUE C

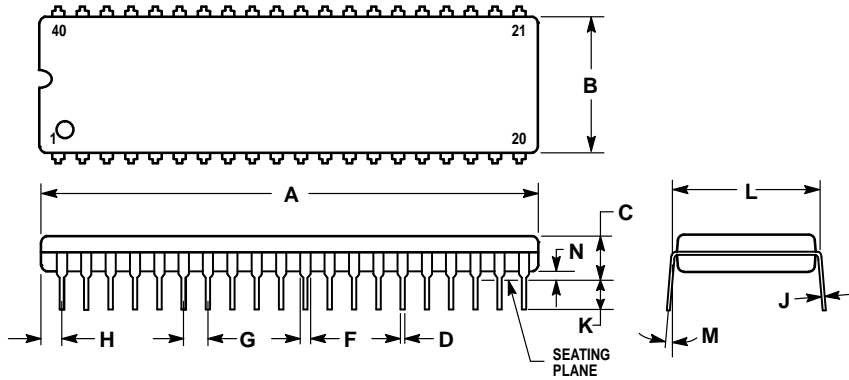

NOTES:

1. POSITIONAL TOLERANCE OF LEADS (D), SHALL BE WITHIN 0.25 (0.010) AT MAXIMUM MATERIAL CONDITION, IN RELATION TO SEATING PLANE AND EACH OTHER.
2. DIMENSION L TO CENTER OF LEADS WHEN FORMED PARALLEL.
3. DIMENSION B DOES NOT INCLUDE MOLD FLASH.

DIM	MILLIMETERS		INCHES	
	MIN	MAX	MIN	MAX
A	51.69	52.45	2.035	2.065
B	13.72	14.22	0.540	0.560
C	3.94	5.08	0.155	0.200
D	0.36	0.56	0.014	0.022
F	1.02	1.52	0.040	0.060
G	2.54 BSC		0.100 BSC	
H	1.65	2.16	0.065	0.085
J	0.20	0.38	0.008	0.015
K	2.92	3.43	0.115	0.135
L	15.24 BSC		0.600 BSC	
M	0°	15°	0°	15°
N	0.51	1.02	0.020	0.040

Motorola reserves the right to make changes without further notice to any products herein. Motorola makes no warranty, representation or guarantee regarding the suitability of its products for any particular purpose, nor does Motorola assume any liability arising out of the application or use of any product or circuit, and specifically disclaims any and all liability, including without limitation consequential or incidental damages. "Typical" parameters which may be provided in Motorola data sheets and/or specifications can and do vary in different applications and actual performance may vary over time. All operating parameters, including "Typicals" must be validated for each customer application by customer's technical experts. Motorola does not convey any license under its patent rights nor the rights of others. Motorola products are not designed, intended, or authorized for use as components in systems intended for surgical implant into the body, or other applications intended to support or sustain life, or for any other application in which the failure of the Motorola product could create a situation where personal injury or death may occur. Should Buyer purchase or use Motorola products for any such unintended or unauthorized application, Buyer shall indemnify and hold Motorola and its officers, employees, subsidiaries, affiliates, and distributors harmless against all claims, costs, damages, and expenses, and reasonable attorney fees arising out of, directly or indirectly, any claim of personal injury or death associated with such unintended or unauthorized use, even if such claim alleges that Motorola was negligent regarding the design or manufacture of the part. Motorola and  are registered trademarks of Motorola, Inc. Motorola, Inc. is an Equal Opportunity/Affirmative Action Employer.

MC44030 MC44035

OUTLINE DIMENSIONS

FTB SUFFIX
PLASTIC PACKAGE
CASE 824D-01
(TQFP-44)
ISSUE O

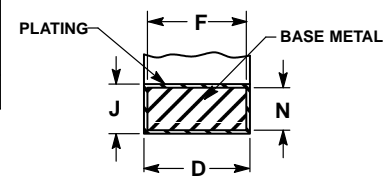
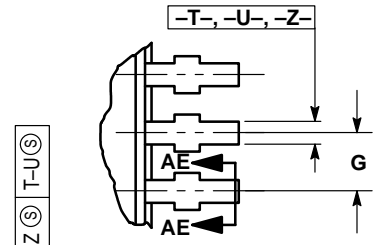
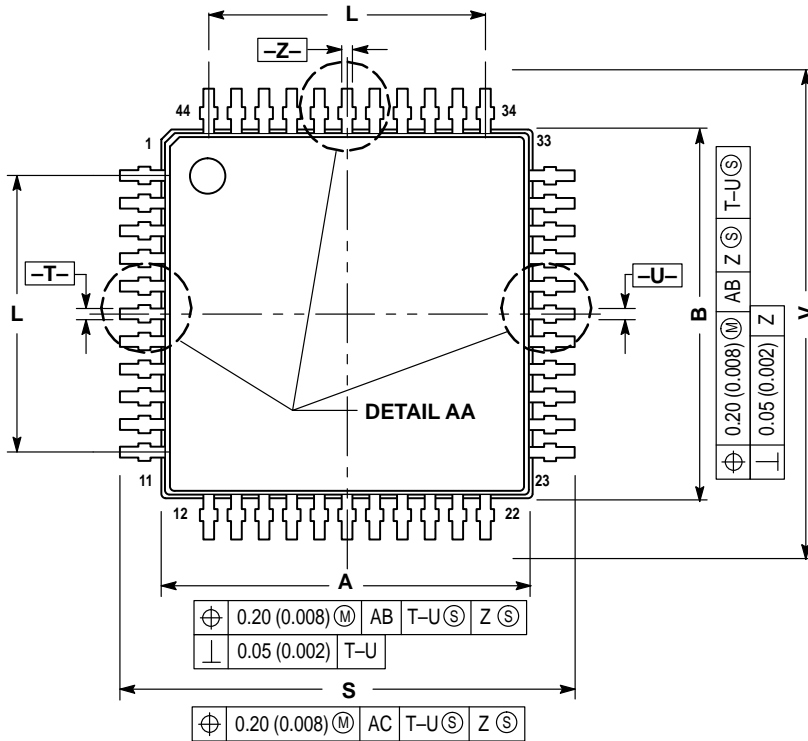

- NOTES:
1. DIMENSIONING AND TOLERANCING PER ANSI Y14.5M, 1982.
 2. CONTROLLING DIMENSION: MILLIMETER.
 3. DATUM PLANE -AB- IS LOCATED AT BOTTOM OF LEAD AND IS COINCIDENT WITH THE LEAD WHERE THE LEAD EXITS THE PLASTIC BODY AT THE BOTTOM OF THE PARTING LINE.
 4. DATUMS -T-, -U- AND -Z- TO BE DETERMINED AT DATUM PLANE -AB-.
 5. DIMENSIONS S AND V TO BE DETERMINED AT SEATING PLANE -AC-.
 6. DIMENSIONS A AND B DO NOT INCLUDE MOLD PROTRUSION. ALLOWABLE PROTRUSION IS 0.25 (0.010) PER SIDE. DIMENSIONS A AND B DO INCLUDE MOLD MISMATCH AND ARE DETERMINED AT DATUM PLANE -AB-.
 7. DIMENSION D DOES NOT INCLUDE DAMBAR PROTRUSION. DAMBAR PROTRUSION SHALL NOT CAUSE THE D DIMENSION TO EXCEED 0.530 (0.021).

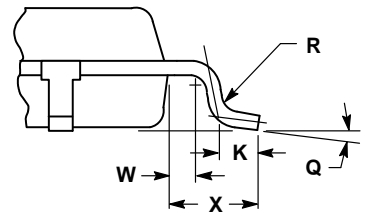
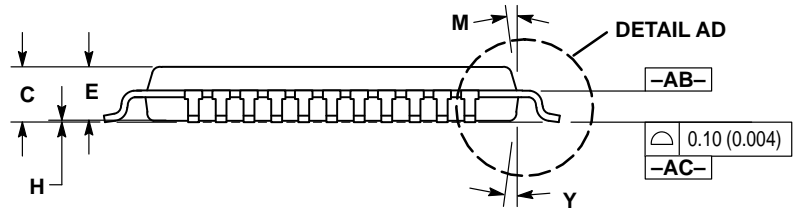

DIM	MILLIMETERS		INCHES	
	MIN	MAX	MIN	MAX
A	9.950	10.050	0.392	0.396
B	9.950	10.050	0.392	0.396
C	1.400	1.600	0.055	0.063
D	0.300	0.450	0.012	0.018
E	1.350	1.450	0.053	0.057
F	0.300	0.400	0.012	0.016
G	0.800 BSC		0.031 BSC	
H	0.050	0.150	0.002	0.006
J	0.090	0.200	0.004	0.008
K	0.450	0.550	0.018	0.022
L	8.000 BSC		0.315 BSC	
M	12° REF		12° REF	
N	0.090	0.160	0.004	0.006
Q	1°	5°	1°	5°
R	0.100	0.200	0.004	0.008
S	11.900	12.100	0.469	0.476
V	11.900	12.100	0.469	0.476
W	0.200 REF		0.008 REF	
X	1.000 REF		0.039 REF	
Y	12° REF		12° REF	

How to reach us:
USA/EUROPE/Locations Not Listed: Motorola Literature Distribution;
 P.O. Box 20912; Phoenix, Arizona 85036. 1-800-441-2447 or 602-303-5454
MFAX: RMFAX0@email.sps.mot.com – TOUCHTONE 602-244-6609
INTERNET: http://Design-NET.com

JAPAN: Nippon Motorola Ltd.; Tatsumi-SPD-JLDC, 6F Seibu-Butsuryu-Center,
 3-14-2 Tatsumi Koto-Ku, Tokyo 135, Japan. 03-81-3521-8315
ASIA/PACIFIC: Motorola Semiconductors H.K. Ltd.; 8B Tai Ping Industrial Park,
 51 Ting Kok Road, Tai Po, N.T., Hong Kong. 852-26629298

