

Technical Data

MC44BC375/D
Rev. 2.6 01/2003

MC44BC375/U/J/T
PLL Tuned VHF Audio/
Video High Integration
Modulator ICs

MC44BC375/U/J/T

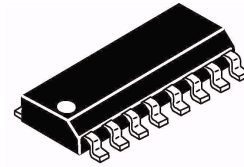

SO16 Package

Ordering Information

Device	Temp. Range	Package
MC44BC375UD, R2 MC44BC375JD, R2 MC44BC375TD, R2	-20°C to +85°C	SO16NB
NOTE: For tape and reel, add R2 suffix.		

Contents List

1 Features	2
2 Device Overview	3
3 Maximum Ratings	4
4 Thermal Rating	4
5 Electrostatic Discharge	4
6 Electrical Characteristics	5
7 Pin Selection	6
8 High Frequency Characteristics (U Version)	6
9 Video Characteristics	7
10 Audio Characteristics	7
11 Characterization Measurement Conditions	7
12 Modulator Functionality	11
13 Pin Circuit Schematics	14
14 MC44BC375U Application Schematic	15
15 Markings and Case Diagrams	16

This modulator circuit is for use in VCRs, set top boxes and similar devices. The device differences are as follows:

- MC44BC375U VHF [CH3 & CH4] (Americas)
- MC44BC375J VHF [CH1 & CH2] (Japan)
- MC44BC375T VHF [CH13] (Taiwan)

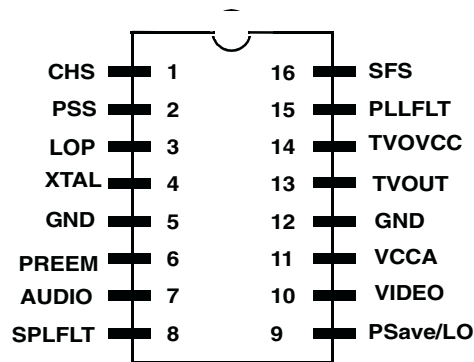

Figure 1. MC44BC375U/J/T Pin Connection Diagram

1 Features

Channels are selectable using pin Channel Selection (CHS) and tuned by a PLL. They do not require any external tank circuit components thus reducing the sensitivity of the PCB design and the need for external adjustments. The PLL obtains its reference from a 4MHz crystal oscillator.

The sound subcarrier is also generated on-chip without external components. The 4.5MHz or 5.5MHz Sound frequency is selectable using pin Sound Frequency Selection (SFS). The Picture to Sound subcarrier ratio is also selectable by pin Picture to Sound selection (PSS) to either 14dB or 16dB. A Power Save function is selectable via pin Psave/LO which turns off all internal VCOs and mixers and simultaneously switches ON the Logic Output Port (LOP). No external Varicap Diodes/ Inductor nor other tuned components are needed.

The MC44BC375/U/J/T also has the following features:

- Channel selected by CHS pin
- Integrated On-Chip Oscillator - No external tank circuit
- Extremely Low External Components Count
- Adjustable Video Modulation Depth (85% w/o adjustment)
- Peak White Clip
- Programmable Picture/Sound Carrier Ratio (14dB & 16dB) selected by PSS pin
- Integrated On-chip Programmable Sound Subcarrier Oscillator (4.5 & 5.5MHz selected by SFS pin)
No external varicaps
- Modulator Standby Mode selected by Psave/LO pin
- Transient Output Inhibit During PLL Lock-up at Power-on
- Logic Output Port selected by Psave/LO pin (Antenna Switch Driver)
- Extremely Robust ESD protection, Minimum 4kV, typical 6kV.
- Available in 80 dBuV RF output level (MC44BC375UA).

2 Device Overview

Figure 2 shows a simplified block diagram of the MC44BC375U/J/T device.

The MC44BC375U/J/T device has two main sections:

1. A modulator section which accepts audio and video inputs and modulates the VHF carrier.
2. A PLL section to synthesize the UHF/VHF output channel frequency (from an integrated UHF oscillator, divided for VHF output)

The high frequency BICMOS technology permits integration of tank circuit and certain filtering functions.

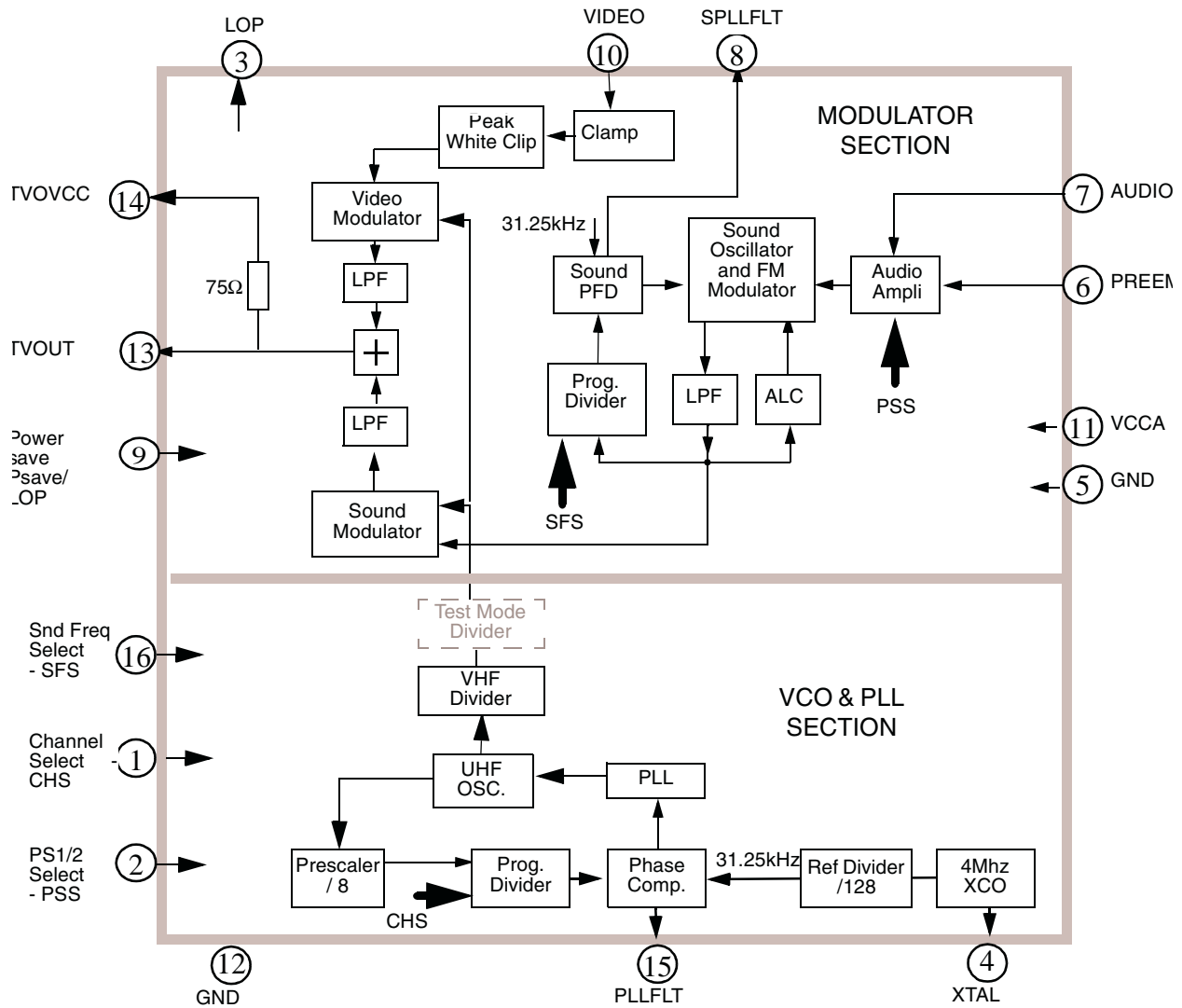

Figure 2. MC44BC375U/J/T Block Diagram

3 Maximum Ratings

Sym	Parameter	Value	Unit
Vcc	Supply voltage	6	V
Tamin	Minimum operating ambient temperature	-20	°C
Tamax	Maximum operating ambient temperature	85	°C
Tstgmin	Minimum storage temperature	-65	°C
Tstgmax	Maximum storage temperature	150	°C
Tj	Junction Temperature	150	°C

This device contains protection circuitry to guard against damage due to high static voltage or electric fields. However, precautions must be taken to avoid applications of any voltage higher than maximum rated voltages to this high impedance circuit. For proper operation, input and output voltages should be constrained to the ranges indicated in the Recommended Operating Conditions.

Maximum ratings are those values beyond which damage to the device may occur. For functional operation, values should be restricted to the Recommended Operating Condition.

Meets Moisture Sensitivity Level 1, no dry pack required.

4 Thermal Rating

Sym	Parameter	Value	Unit
R _{thja}	Thermal resistance from Junction to Ambient	140	°C/W

5 Electrostatic Discharge

Electrostatic Discharge (ESD) tests are done on all pins.

Sym	Parameter	Min	Typ	Unit
ESD	MM (Machine Model) - MIL STD 883C method 3015-7	200	500	V
ESD	HBM (Human Body Model) - MIL STD 883C method 3015-7	4000	6000	V

6 Electrical Characteristics

- A = 100% Tested
- B = 100% Correlation tested
- C = Characterized on samples
- D = Design parameter

6.1 Specification Conditions

Unless otherwise stated: Vcc = 5.0V, T amb. = 25°C. Video input 1Vp-p, 10 step greyscale. RF inputs / outputs into 75Ω load. SPECIFICATIONS ONLY VALID FOR ENVELOPE DEMODULATION

Power Supply Parameters	Min	Typ	Max	Unit	Notes	Type
Operating Supply Voltage range	4.5	5.0	5.5	V		B
Total Supply Current	40	47	55	mA	All sections active	A
Total Standby Mode Supply Current	3	5	7	mA	PSave/LO=LO	A

DC Parameter	Min	Typ	Max	Unit	Type
Threshold voltage level on pins CHS, PSS, SFS, PSave/LO		2.1		V	C
Sound Comparator Charge Pump Current: During locking When locked	7	10	12	μA	A
	0.7	1	1.5	μA	A
RF Comparator Charge Pump Current	60	100	150	μA	A
Crystal Oscillator Stability - negative resistance	1	-	-	KΩ	D
Logic Output Port: Saturation voltage @ I=15mA Leakage current	-	210	300	mV	A
	-	-	1	uA	A

7 Pin Selection

Pin Nb	Pin Name	Device	LO (grounded)	HI (Open or +5V)
1	CHS	MC44BC375U MC44BC375J MC44BC375T	CH4 CH2 CH13	CH3 CH1 CH13
2	PSS	MC44BC375U/J/T	14dB	16dB
9	PSave/LO	MC44BC375U/J/T	Power save Mode LOP pin LO (Low voltage)	Normal Operation LOP pin HI (High impedance)
16	SFS	MC44BC375U/J/T	5.5Mhz	4.5Mhz

By default (open condition), all pins are “HI”.

7.1 Test Modes

Pin	DC level	Description
CHS	Vcc + 0.3V	Low frequency testing (RF frequency divided by 4 for MC44BC375U/J, and divided by 8 for MC44BC375T)
	Vcc + 1.1V	Base band test mode (DC drive applied to modulators)
PSS	Vcc + 1Vbe	Transient Output Inhibit Disabled
SFS	Vcc + 1Vbe	Sound Oscillator OFF
VIDEO	Vcc + 0.3V	Force UHF and Sound PLL Upper current source
	Vcc + 1.1V	Force UHF and Sound PLL Lower current source

NOTE:

Test modes are intended for manufacturing test purpose only and not to be used for normal application.

8 High Frequency Characteristics (U Version)

For all the following specifications and unless otherwise stated: Vcc = 5.0V, T amb. = 25°C. Video input 1Vp-p, 10 step greyscale. RF inputs / outputs into 75Ω load. SPECIFICATIONS ONLY VALID FOR ENVELOPE DEMODULATION. Measured on U version on both channel 3 and 4. See Section 11, “Characterization Measurement Conditions” on page 7 for “C” type parameters.

Parameter	Test Conditions	Min	Typ	Max	Unit	Type
TV OUT output level		74	76	79	dBμV	B
Sound subcarrier Harmonics (fp+n*fs)	Ref Picture carrier	-	-73	-65	dBc	C
Second Harmonic of chroma subcarrier.	Using red EBU bar	-	-65	-55	dBc	C
Chroma/Sound intermodulation: fp + (fsnd-fchr)	Using red EBU bar	-	-65	-60	dBc	C
Fo (picture carrier) Harmonics (See Note1)	2nd harmonic		30	42	dBμV	C
	3rd harmonic		66	69	dBμV	C
Out Band (picture carrier) Spurious	1/2*Fo - 1/4*Fo - 3/2*Fo - 3/4*Fo			27	dBμV	C
In band spurious (Fo +/- 5 MHz range)	No video or sound modulation		-70	-62	dBc	C
4 MHz Crystal Spurious (Fo +/- 4 MHz)	No video or sound modulation		-82	-75	dBc	C

Note: 1: Picture carrier harmonics are highly dependant on PCB layout and decoupling capacitors.

9 Video Characteristics

Parameter	Test Conditions	Min	Typ	Max	Unit	Type
Video bandwidth	Reference 0dB at 100kHz, measured at 5MHz	-1.5	-0.5	—	dB	C
Video input level	75Ohm load	—	—	1.5	V _{cvbs}	D
Video input current		—	0.2	1	μA	A
Video input impedance		500	—	—	KΩ	A
Video S/N	Unweighted	49	52	—	dB	C
	Weighted	56	60	—	dB	C
Differential Phase			+/-1	+/-5	deg	C
Differential Gain			1	5	%	C
Luma/Sync ratio	Input ratio 7.0:3.0	6.8/3.2	—	7.2/2.8	—	B
Video modulation depth	Video input level=1.0 V _{cbvs}	80	85	90	%	B
Peak White Clip	Video Modulation Depth for Video=1.4 V _{cbvs}	90.5	95	99.5	%	B

10 Audio Characteristics

All audio measurement use specified pre-emphasis circuit.

Parameter	Test Conditions	Min	Typ	Max	Unit	Type
Picture to Sound ratio	PSS (Pin2) = HI	14	16	18	dB	B
	PSS (Pin2) =LO	12	14	16	dB	
Picture to Sound ratio difference	between PSS = HI and PSS = LO	1.5	2.0	2.5	dB	B
Audio FM Modulation Depth	Using specific pre-emphasis circuit - Audio Input: 1Khz @ 205 mVrms					
	Fs = 4.5 MHz (100% Modulation = +/- 25 kHz FM Deviation)	75	85	95	%	B
	Fs = 5.5 MHz (100% Modulation = +/- 50 kHz FM Deviation)	75	85	95	%	B
Audio input resistance		45	55	61	kΩ	A
Audio Frequency response	0dB ref @ 1kHz Measure from 50Hz to 15kHz	-2.5	-	+2	dB	C
Audio Distortion FM (THD only)	At 1 kHz and 100% mod (+/- 50 kHz) - No Video	-	0.3	1	%	C
Audio S/N with Sync Buzz FM		50	53	-	dB	C

11 Characterization Measurement Conditions

Device default configuration unless otherwise specified:

- Sound subcarrier frequency = 5.5Mhz
- Picture-to-sound carrier ratio = 12dB
- CH3 & CH4 frequencies

RF Inputs / Output into 75ohm Load using a 75 to 50 ohm transformation. Video Input 1V pk-pk. Audio pre-emphasis circuit engaged.

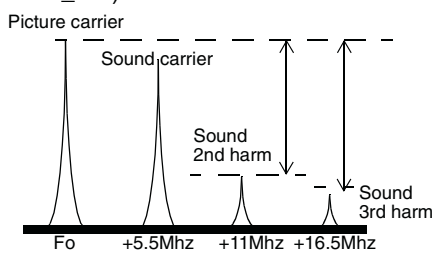
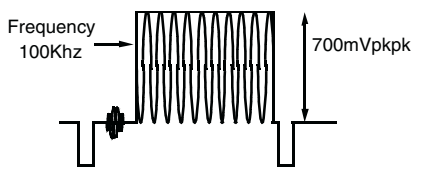
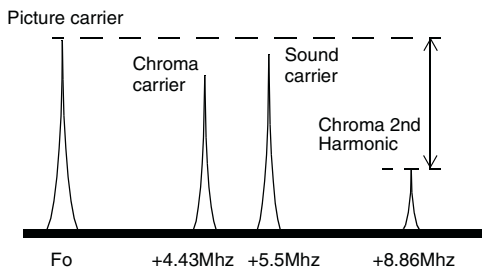
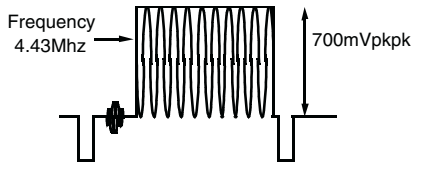
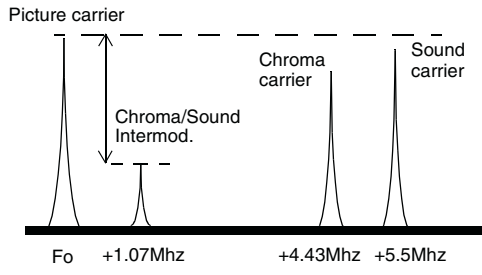
Device and Signals Set-up	Measurement Set-up
TVOUT Output Level	
Video: 10 steps grey scale No audio	Measured picture carrier in dBuV with the HP8596E Spectrum Analyzer using a 75 to 50 ohm transformation, all cables losses and transformation pads having been calibrated. Measurement used as a reference for other tests: TVout_Ref
Sound Subcarrier Harmonics	
Video: 10 steps grey scale No Audio signal	Measure in dBc second and third sound harmonics levels in reference to picture carrier (TVout_Ref). 
Second Harmonics of Chroma subcarrier	
No audio Video: a 700mVpk-pk 100Khz sinusoidal signal is inserted on the black level of active video area. 	Measure in dBc, in reference to picture carrier (TVout_Ref), second harmonic of chroma at channel frequency plus 2 times chroma frequency, resulting in the following spectrum. 
Chroma/Sound intermodulation	
No audio signal Video: 700mVpk-pk 100Khz sinusoidal signal inserted on the black level of active video area. This is generated using a Rohde & Schwarz Video Generator SAF and inserting the required frequency from a RF Signal generator. 	Measure in dBc, in reference to picture carrier (TVout_Ref), intermodulation product at channel frequency plus the sound carrier frequency (+5,5Mhz) minus the chroma frequency (-4,43Mhz), resulting in the following spectrum. Intermodulation product is at the channel frequency +1,07Mhz. 
Picture Carrier Harmonics	

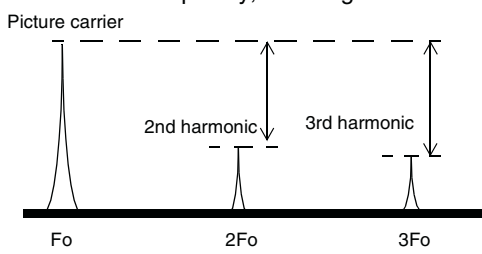
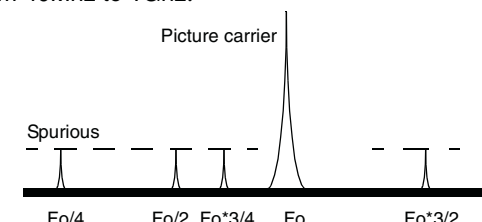
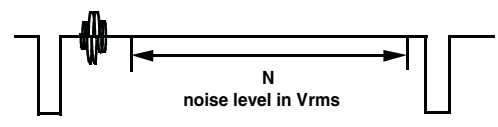
Device and Signals Set-up	Measurement Set-up
No Video signal No Audio signal	Measure in dBc, in reference to picture carrier (TVout_Ref), second and third harmonic of channel frequency, resulting in the following spectrum. 
Out of Band Spurious	
No Video signal No Audio signal	Measure in dBuV spurious levels at 0.25, 0.5, 0.75 and 1.5 times channel frequency, resulting in the following spectrum Measure from 40Mhz to 1Ghz. 
In Band Spurious / 4Mhz Crystal Spurious	
No Video signal No Audio signal	Measure in dBc, in reference to picture carrier (TVout_Ref), spurious levels falling into video bandwidth $Fo \pm 5\text{Mhz}$ (15.125Khz & 31.25Khz from reference dividers and 4Mhz from crystal).
Video Bandwidth	
No audio Video: 600mVpk-pk sinusoidal signal inserted on the black level of active video area.	The Video signal is demodulated on the spectrum analyzer, and the peak level of the 100Khz signal is measured as a reference. The frequency is then swept from 100Khz to 5Mhz, and then the difference in dBc from the 100Khz reference level is measured.
Weighted Video Signal to Noise	
Video: 100% White video signal - 1Vpk-pk. No Audio signal This is measured using a Rohde & Schwarz AMFS Demodulator in B/G (using a CCIR Rec. 567 weighting network, 100kHz to 5MHz band with sound trap and envelope detection, and a Rohde & Schwarz UAF Video Analyzer.	The Video Analyzer measures the ratio between the amplitude of the active area of the video signal (700mV) and the noise level in V_{rms} on a video black level which is show below. VideoS/N is calculated as $20 \times \log(700 / N)$ in dB 
Unweighted Video Signal to Noise	
Same as above with CCIR filter disabled.	Same as above.
Video Differential Phase	

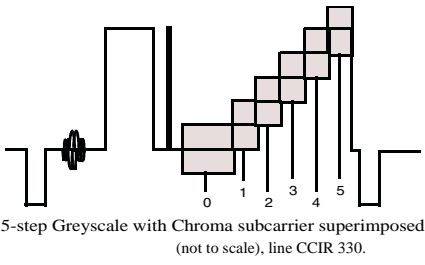
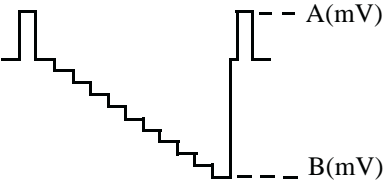
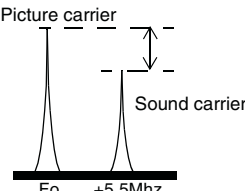
Device and Signals Set-up	Measurement Set-up
<p>Video: 5 step Grey Scale- 1Vpk-pk. No Audio signal This is measured using a Rohde & Schwarz AMFS Demodulator in B/G (using a CCIR Rec. 567 weighting network, 100kHz to 5MHz band with sound trap, and envelope detection, and a Rohde & Schwarz UAF Video Analyzer.</p>	<p>On line CCIR 330, the video analyzer DP measure consists of calculating the difference of the Chroma phase at the black level and the different chroma subcarrier phase angles at each step of the greyscale. The largest positive or negative difference indicates the distortion.</p> $\text{DIFF PHASE} = \frac{\text{the largest positive or negative difference}}{\text{the phase at position 0}} * 100\%$ <p>The video analyzer method takes the worst step from the first 4 steps.</p>
Video Differential Gain	
<p>Video: 5 step Grey Scale- 1Vpk-pk. No Audio signal This is measured using a Rohde & Schwarz AMFS Demodulator in B/G (using a CCIR Rec. 567 weighting network, 100kHz to 5MHz band with sound trap and envelope detection, and a Rohde & Schwarz UAF Video Analyzer.</p>	<p>On line CCIR 330 shown below, the video analyzer DG measure consists of calculating the difference of the Chroma amplitude at the black level and the different amplitudes at each step of the greyscale. The largest positive or negative difference indicates the distortion.</p>  <p align="center">5-step Greyscale with Chroma subcarrier superimposed (not to scale), line CCIR 330.</p> $\text{DIFF GAIN} = \frac{\text{the largest positive or negative difference}}{\text{the amplitude at position 0}} * 100\%$ <p>The video analyzer method takes the worst step from the first 4 steps. CCIR line 330 corresponds to FCC line 17 in NTSC/M standard</p>
Video Modulation Depth	
<p>No Audio signal Video: 10 step grey scale</p>	<p>This is measured using a HP8596E Spectrum Analyzer with a TV Trigger option, allowing demodulation and triggering on any specified TV Line. The analyzer is centred on the maximum peak of the Video signal and reduced to zero Hertz span in Linear mode to demodulate the Video carrier.</p>  <p align="center">TV Line Demodulated by Spectrum Analyzer-BG standard The Modulation Depth is calculated as $(A-B)/A \times 100$ in%</p>
Picture to Sound ratio	
<p>No Video signal No Audio Signal "PS" bit set to 0 and 1</p>	<p>Measure in dBc sound carrier in reference to picture carrier (TVout_Ref) for "PS" bit=0 (PS=12dB typical) and for "PS" bit=1 (PS=16dB),</p> 
Audio Modulation Depth - FM Modulation	

Device and Signals Set-up	Measurement Set-up
Video Black Level Audio signal: 1Khz, 205mVrms. This is measured using a Rohde & Schwarz AMFS Demodulator in B/G and a HP8903A Audio Analyzer at 1kHz	The audio signal 205mV at 1kHz is supplied by the Audio Analyzer, and the FM demodulated signal deviation is indicated on the Demodulator in Khz peak. This value is then converted in% of FM deviation, based on specified standards.
Audio Frequency response	
Video Black Level Audio signal: 50Hz to 15KHz, 100mV _{rms} This is measured using a Rohde & Schwarz AMFS Demodulator in B/G and a HP8903A.	The audio signal 1KHz 100mV _{rms} is supplied by the Audio Analyzer, demodulated by the Demodulator and the audio analyzer measures the AC amplitude of this demodulated audio signal: this value is taken as a reference (0dB). The audio signal is then swept from 50Hz to 15KHz, and demodulated AC amplitude is measured in dB relative to the 1KHz reference. Audio pre-emphasis and de-emphasis circuits are engaged, all audio analyzer filters are switched OFF.
Audio Distortion FM	
Audio: 1Khz, adjustable level Video Black Level This is measured using a Rohde & Schwarz AMFS UHF Demodulator in B/G and a HP8903A Audio Analyzer at 1kHz. The output level of the Audio analyzer is varied to obtain a deviation of 50kHz indicated on the Demodulator.	The input rms detector of the Audio Analyzer converts the ac level of the combined signal + noise + distortion to dc. It then removes the fundamental signal (1kHz) after having measured the frequency. The output rms detector converts the residual noise + distortion to dc. The dc voltmeter measures both dc signals and calculates the ratio in% of the two signals. $ADist = (Distorsion + Noise)/(Distorsion + Noise + Signal)$
Audio Signal to Noise	
Audio: 1Khz, adjustable level Video: EBU Color Bars This is measured using a Rohde & Schwarz AMFS Demodulator in B/G and a HP8903A Audio Analyzer at 1kHz. The output level of the Audio analyzer is varied to obtain a Modulation Deviation of 25kHz indicated on the AMFS Demodulator.	The Audio Analyzer alternately turns ON and OFF it's internal audio source to make a measure of the Audio signal plus noise and then another measure of only the noise. The measurement is made using the internal CCIR468-2 Filter of the Audio Analyzer together with the internal 30+/-2kHz (60dB/decade) Lowpass filters. The AMFS demodulator uses a quasi-parallel demodulation as is the case in a normal TV set. In this mode the Nyquist filter is bypassed and the video carrier is used without added delay to effectuate intercarrier conversion. In this mode the phase noise information fully cancels out and the true S/N can be measured $ASN(dB) = 20 \times \log(Signal + Noise)/(Noise)$

12 Modulator Functionality

12.1 Power Supply

The two device Vccs (pins 11 and 14) must be applied at the same time to ensure all internal blocks are correctly biased. All other pins must not be biased before Vcc is applied to device.

12.2 Test modes

The MC44BC375U/J/T test modes are enabled by any voltage level higher than V_{cc} on pins CHS, PSS, SFS and VIDEO. Care must be taken in the application to not reach levels higher than V_{cc} on those pins.

12.3 Standby modes

During standby mode, the modulator is switched to low power consumption: the sound oscillator, UHF oscillator and VHF dividers, video and sound modulator sections bias are internally turned OFF.

Modulator is programmed in standby mode when pin 9 PSave/LO is set to “LO” level (See PIN SELECTION section).

12.4 Logic Output Port

The Logic Output Port is used to control an external switch (such as an antenna switch or an attenuator). This pin is an open collector transistor able to drive up to 15mA at low voltage.

LOP level is switched between “HI” and “LO” level with pin 9 “Psave/LO” (See PIN SELECTION section).

12.5 Transient Output Inhibit

To minimize the risk of interference to other channels while the UHF PLL is acquiring a lock on the desired frequency, the Sound and Video modulators are turned OFF at power-ON from zero (i.e. V_{cc} is switched from 0V to 5V or device is switched from “Standby mode” to “Normal operation”).

There is a time-out of 263ms until the output is enabled. This lets the UHF PLL settle to its programmed frequency. During the 263ms time-out, the sound PLL current source is set to 10μA typical to speed up the locking time; after the 263ms time-out, the current source is switched to 1μA. Use care when selecting loop filter components, to ensure the loop transient does not exceed this delay.

For test purposes, it is possible to disable the 263ms delay (see TEST MODES section).

12.6 Video section

The modulator requires a composite video input with negative going sync pulses and a nominal level of 1V_{p-p}. This signal is AC coupled to the video input where the sync tip level is clamped.

Video modulation depth typical value is given for 1V_{CBVS} input level. It can be adjusted to any lower value by simply adding a resistive divider at video input, resulting in a lower signal seen by the video input stage.

The video signal is then passed to a peak white clip circuit whose function is to soft clip the top of the video waveform if the amplitude from the sync tip to peak white goes too high. In this way over-modulation of the carrier by the video is avoided. The clipping function is always engaged.

12.7 Sound section

The multivibrator oscillator is fully integrated and does not require any external component. An internal low pass filter and matched structure give very low harmonics level.

The sound modulator system consists of an FM modulator incorporating the sound subcarrier oscillator. The audio input signal is AC coupled into the amplifier which then drives the modulator.

The audio pre-emphasis circuit is a high-pass filter with an external capacitor C1 and an internal resistor (100kOhms typical). The recommended capacitor value (750pF) is for M/N standards; time constant is 75μs. It is 470pF for B/G standards (50μs).

Audio bandwidth specification is for 50Hz to 15Khz range, with pre-emphasis circuit engaged. Without this pre-emphasis circuit, it is possible to extend the audio bandwidth to the high frequencies as there is no internal frequency limitation (stereo application).

12.8 PLL Section — Dividers

The reference divider is a fixed divide by 128 resulting in a reference frequency of 31.25Khz with a 4.0Mhz crystal. The 31.25Khz reference frequency is used for both UHF and Sound PLLs.

The prescaler is a fixed divide by 8 and is permanently engaged. The VHF divider is different for each of the 3 versions.

The programmable divider's division ratio is controlled by CHS pin voltage in order to get the following VHF frequencies:

Device	Channel	VHF divider
MC44BC375U	CH3 = 61.25Mhz	8
	CH4 = 67.25Mhz	
MC44BC375J	CH1 = 91.25Mhz	6
	CH2 = 97.25Mhz	
MC44BC375T	CH13 = 211.25Mhz	3

12.9 Selectable Pins

Pins CHS, PSS, SFS are internally pulled up to 5V.

13 Pin Circuit Schematics

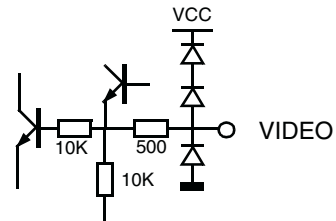
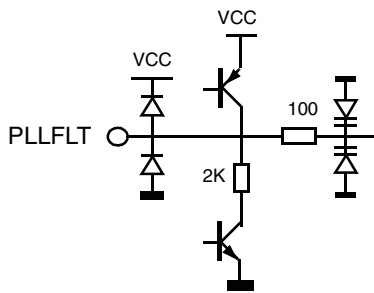
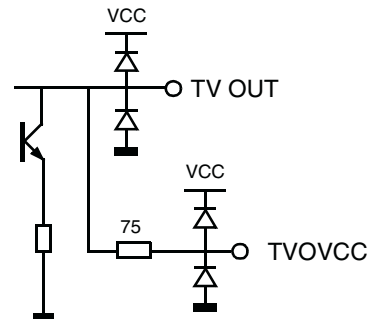
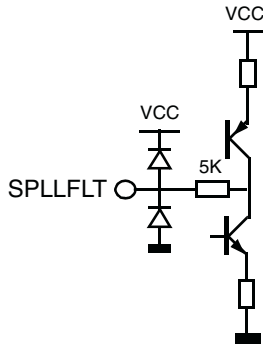
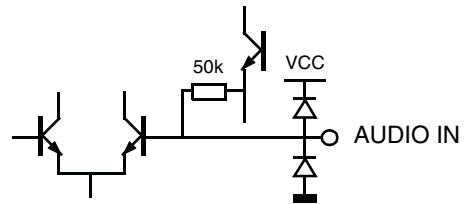
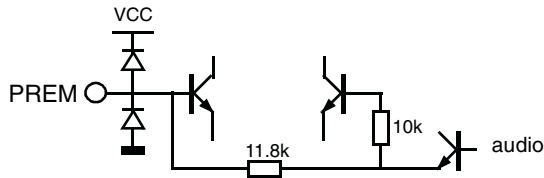
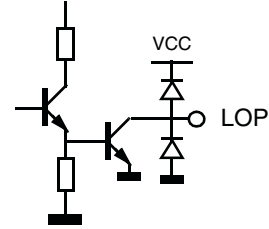
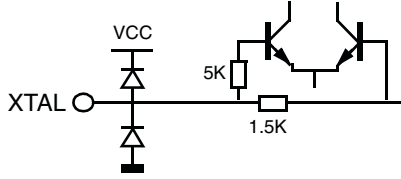
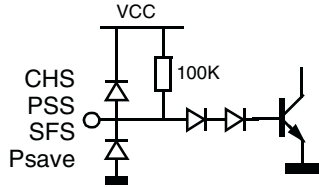
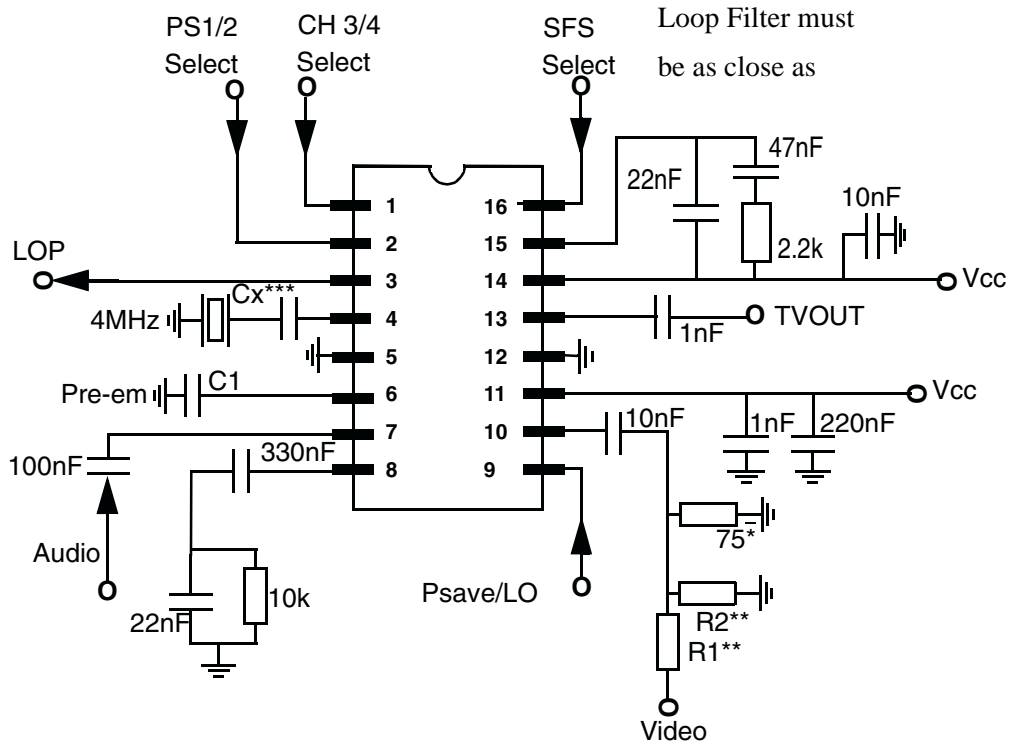

Figure 3. Pin Schematics

Freescale Semiconductor, Inc.

14 MC44BC375U Application Schematic

This document contains information on a new product under development. Motorola reserves the right to change or discontinue this product without notice.



*: This 75Ω is to match with a 75Ω video signal applied thru coaxial cable. It can be removed in case of high impedance video generator.

R1 and R2 are to reduce video modulation depth from typical value (for example R1=1KΩ and R2=10KΩ reduce VMD by about 8%)

Cx is dependant on the crystal characteristics (Cx=27pF on Motorola application Board)

C1 value depends on standard: 470pF is for 50μs pre-emphasis time constant (B/G standard) and 750pF is for 75μs (M/N standard).

Figure 4. MC44BC375U Application Schematic

Freescale Semiconductor, Inc.

15 Markings and Case Diagrams

15.1 Pin Description

N°	Symbol	Pin description	Functionality
1	CHS	Channel Select	Channel 3 / Channel 4 selection for MC44BC375U Channel 1 / Channel 2 selection for MC44BC375J Don't care for the MC44BC375T
2	PSS	Picture to Sound Select	PS=14dB / PS=16dB selection
3	LOP	Logic Output Port	Logic Output Level (Low voltage / high impedance) selectable via Pin 9
4	XTAL	Crystal	Crystal Oscillator input
5	Gnd	Ground	
6	PREEM	Pre-emphasis	Audio Pre-emphasis capacitor
7	AUDIO	Audio Input	
8	SPLFLT	Sound PLL Filter	
9	PSave/LO	PowerSave & Logic Output control	Normal Mode / Power save mode selection In Power Save Mode, the LOP pin is automatically switched to low voltage
10	VIDEO	Video Input	
11	VCCA	Voltage supply	
12	GND	Ground	
13	TVOUT	TV Output	Modulated signal Output
14	TVOVCC	Voltage supply	
15	PLLFLT	PLL Filter	UHF PLL Filter
16	SFS	Sound Frequency Select	Sound frequency 4.5Mhz / 5.5Mhz selection

15.2 Packaging Instructions

Tape and reel packaging per 12MRH00360A with the following conditions applicable for Dual In-Line SOP (SOIC) package.

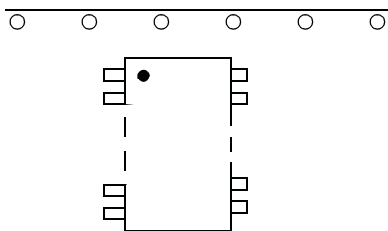

Component Orientation: Arrange parts with the pin 1 side closest to the tape's round sprocket holes on the tape's trailing edge.

15.3 Marking Instructions

In accordance with 12MRH00191A internal specification applied for Dual in-line SO package.

Bar marked part way across Pin 1 end of package.
Bar width 10 to 20 mils, length to be at least four times Bar width. Bar placement may extend across chamfer and dimple areas.

Pin 1 Dot or Dimple

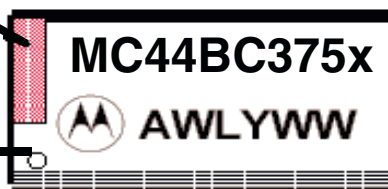

- 1st line:
MC44BC375U for MC44BC375UD device
MC44BC375J for MC44BC375JD device
MC44BC375T for MC44BC375TD device
(Part number coded on 10 digits)
- 2nd line:
Assembly site code AW (2 digits) followed by the wafer lot code L (1 digit), year Y (1 digit) and work week WW (2 digits)

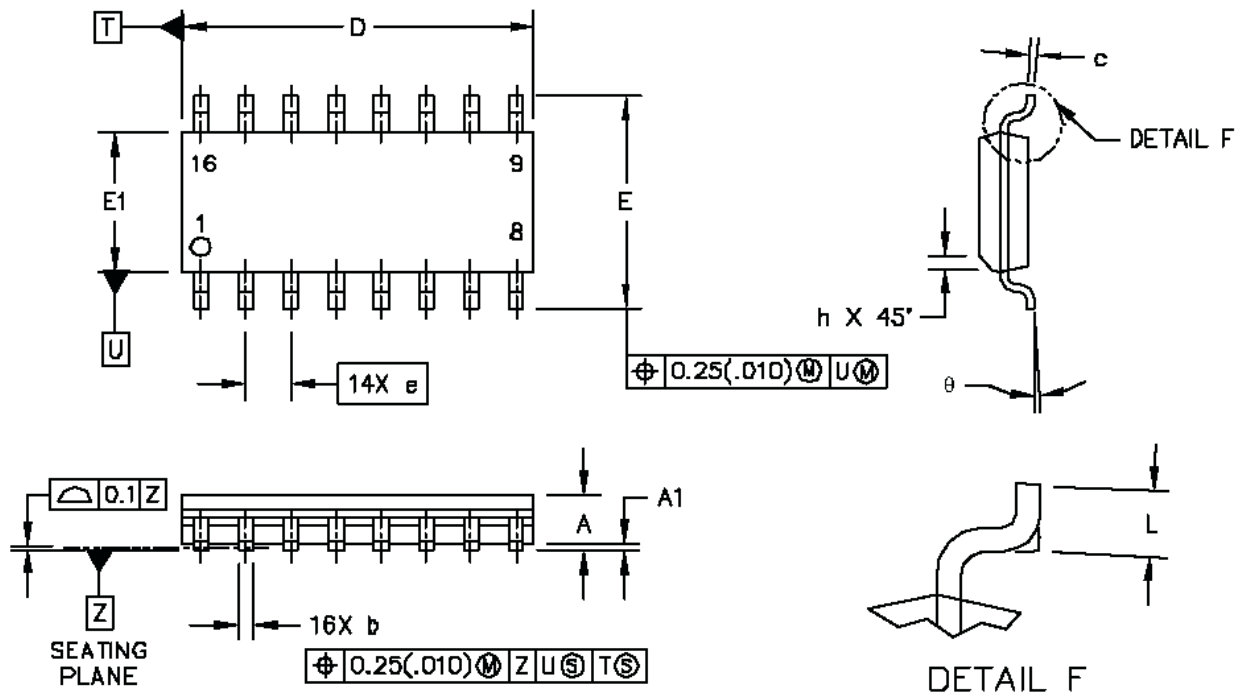

Dim	Millimeters		Inches	
	Min	Max	Min	Max
A	1.35	1.75	0.054	0.068
A1	0.1	0.25	0.004	0.009
D	9.8	10	0.385	0.393
E	5.8	6.2	0.229	0.244
E1	3.8	4	0.150	0.157
b	0.35	0.49	0.014	0.019
c	0.19	0.25	0.008	0.009
e	1.27 BSC		0.050 BSC	
L	0.4	1.25	0.016	0.049
h	0.25	0.5	0.010	0.019
Q	0°	7°	0°	7°

- Note:** 1. Dimensions and Tolerances per ASME Y14.5M, 1994.
- Note:** 2. Controlling dimension: Millimeters.
- Note:** 3. Dimension D and E1 do not include mold protrusion.
- Note:** 4. Maximum mold protrusion 0.15 (0.006) per side.
- Note:** 5. Dimension b does not include Dambar protrusion. Allowable Dambar protrusion shall be 0.127 (0.005) total in excess of the b dimension at maximum material condition.

Figure 5. SO16NB Package

Freescale Semiconductor, Inc.

Home Page:

www.freescale.com

email:

support@freescale.com

USA/Europe or Locations Not Listed:

Freescale Semiconductor
Technical Information Center, CH370
1300 N. Alma School Road
Chandler, Arizona 85224
(800) 521-6274
480-768-2130
support@freescale.com

Europe, Middle East, and Africa:

Freescale Halbleiter Deutschland GmbH
Technical Information Center
Schatzbogen 7
81829 Muenchen, Germany
+44 1296 380 456 (English)
+46 8 52200080 (English)
+49 89 92103 559 (German)
+33 1 69 35 48 48 (French)
support@freescale.com

Japan:

Freescale Semiconductor Japan Ltd.
Headquarters
ARCO Tower 15F
1-8-1, Shimo-Meguro, Meguro-ku
Tokyo 153-0064, Japan
0120 191014
+81 2666 8080
support.japan@freescale.com

Asia/Pacific:

Freescale Semiconductor Hong Kong Ltd.
Technical Information Center
2 Dai King Street
Tai Po Industrial Estate,
Tai Po, N.T., Hong Kong
+800 2666 8080
support.asia@freescale.com

For Literature Requests Only:

Freescale Semiconductor
Literature Distribution Center
P.O. Box 5405
Denver, Colorado 80217
(800) 441-2447
303-675-2140
Fax: 303-675-2150
LDCForFreescaleSemiconductor
@hibbertgroup.com

RoHS-compliant and/or Pb-free versions of Freescale products have the functionality and electrical characteristics of their non-RoHS-compliant and/or non-Pb-free counterparts. For further information, see <http://www.freescale.com> or contact your Freescale sales representative.

For information on Freescale's Environmental Products program, go to <http://www.freescale.com/epp>.

Information in this document is provided solely to enable system and software implementers to use Freescale Semiconductor products. There are no express or implied copyright licenses granted hereunder to design or fabricate any integrated circuits or integrated circuits based on the information in this document. Freescale Semiconductor reserves the right to make changes without further notice to any products herein. Freescale Semiconductor makes no warranty, representation or guarantee regarding the suitability of its products for any particular purpose, nor does Freescale Semiconductor assume any liability arising out of the application or use of any product or circuit, and specifically disclaims any and all liability, including without limitation consequential or incidental damages. "Typical" parameters which may be provided in Freescale Semiconductor data sheets and/or specifications can and do vary in different applications and actual performance may vary over time. All operating parameters, including "Typicals" must be validated for each customer application by customer's technical experts. Freescale Semiconductor does not convey any license under its patent rights nor the rights of others. Freescale Semiconductor products are not designed, intended, or authorized for use as components in systems intended for surgical implant into the body, or other applications intended to support or sustain life, or for any other application in which the failure of the Freescale Semiconductor product could create a situation where personal injury or death may occur. Should Buyer purchase or use Freescale Semiconductor products for any such unintended or unauthorized application, Buyer shall indemnify and hold Freescale Semiconductor and its officers, employees, subsidiaries, affiliates, and distributors harmless against all claims, costs, damages, and expenses, and reasonable attorney fees arising out of, directly or indirectly, any claim of personal injury or death associated with such unintended or unauthorized use, even if such claim alleges that Freescale Semiconductor was negligent regarding the design or manufacture of the part.



MC44BC375/D

**For More Information On This Product,
Go to: www.freescale.com**