



Dual 2.2W Audio Amplifier Plus Stereo Headphone Function

General Description

The MC4863 is a dual bridge-connected audio power amplifier which, when connected to a 5V supply, will deliver 2.2W to a 4Ω load(Note 1) or 2.5W to a 3Ω load(Note 2) with less than 1.0% THD+N. In addition, the headphone input pin allows the amplifiers to operate in single-ended mode to drive stereo headphones.

Boomer audio power amplifiers were designed specifically to provide high quality output power from a surface mount package while requiring few external components, to simplify audio system design, it combines dual bridge speaker amplifiers and stereo headphone amplifiers on one chip.

The MC4863 features an externally controlled, low-power consumption shutdown mode, a stereo headphone amplifier mode, and thermal shutdown protection. It also utilizes circuitry to reduce “clicks and pops” during device turn-on.

Features

- P_o at 1% THD+N
 - into 3Ω 2.5W(typ)
 - into 4Ω 2.2W(typ)
 - Into 8Ω 1.1W(typ)
- Single-ended mode - THD+N 0.5%(max) at 75mW into 32Ω
- Shutdown current 0.7μA(typ)
- Stereo headphone amplifier mode
- “Click and pop” suppression circuitry
- Unity-gain stable
- Thermal shutdown protection circuitry
- The available in a SOP16 package and TSSOP16-EP, TSSOP20 and TSSOP20-EP packages

Applications

- Multimedia monitors
- Portable and desktop computers
- Portable televisions

Note 1: An MC4863 which has been properly mounted to the circuit board will deliver 2.2W into 4Ω. The other package options for the MC4863 will deliver 1.1W into 8Ω. See the Application Information section for MC4863 usage information.

Note 2: An MC4863 which has been properly mounted to the circuit board and forced-air cooled will deliver 2.5W into 3Ω.

Dual 2.2W Audio Amplifier Plus Stereo Headphone Function

Pin Configuration

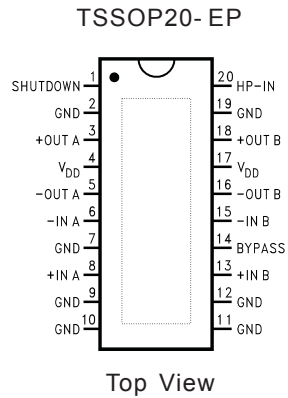
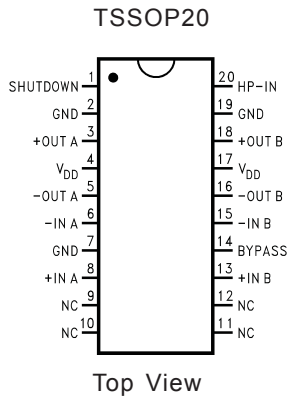
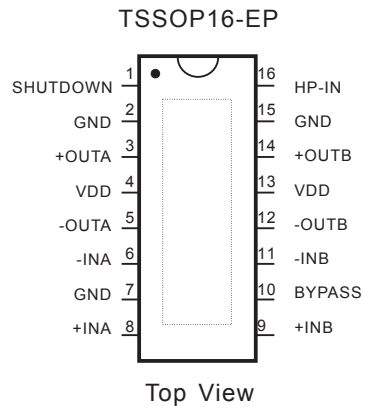
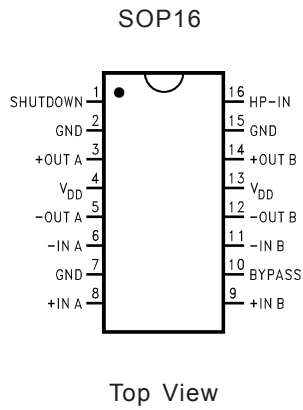

Dual 2.2W Audio Amplifier Plus Stereo Headphone Function

Typical Application

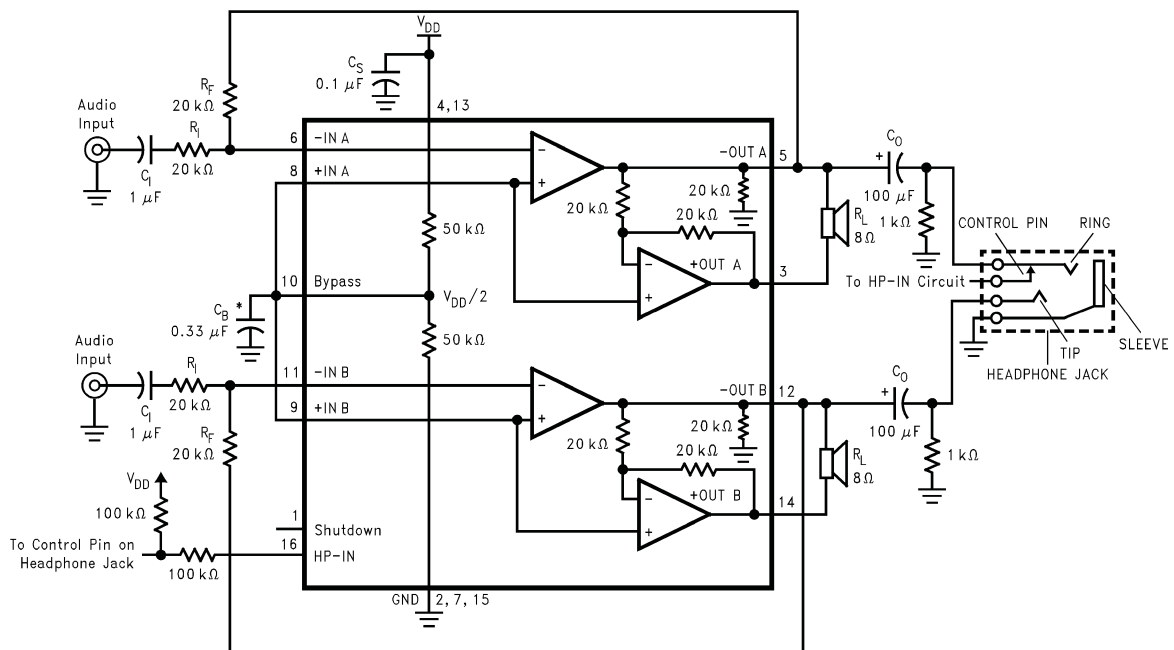

Figure 1. Typical Audio Amplifier Application Circuit



Dual 2.2W Audio Amplifier Plus Stereo Headphone Function

Absolute Maximum Ratings¹

Item	Value	Unit	
Supply Voltage	6	V	
Power Dissipation	Internally limited		
Input Voltage	- 0.3V to V _{DD} +0.3V	V	
Junction Temperature	150	°C	
Storage Temperature Range	- 65 to 150	°C	
Solder Information Small Outline Package	Vapor Phase(60 sec)	215	°C
	Infrared(15 sec)	220	°C

Recommended Operating Condition

Item	Min	Max	Unit
Supply Voltage	2.0	5.5	V
Temperature Range	-40	85	°C

Thermal Information²

Symbol	Description	Value	Unit
$\theta_{JC}(SOP16)$	Thermal Resistance-Junction to Case	20	°C/W
$\theta_{JA}(SOP16)$	Thermal Resistance-Junction to Ambient	80	°C/W
$\theta_{JC}(TSSOP20)$	Thermal Resistance-Junction to Case	20	°C/W
$\theta_{JA}(TSSOP20)$	Thermal Resistance-Junction to Ambient	80	°C/W
$\theta_{JC}(TSSOP16-EP)$	Thermal Resistance-Junction to Case	2	°C/W
$\theta_{JA}(TSSOP16-EP)$	Thermal Resistance-Junction to Ambient	58	°C/W
$\theta_{JC}(TSSOP20-EP)$	Thermal Resistance-Junction to Case	2	°C/W
$\theta_{JA}(TSSOP20-EP)$	Thermal Resistance-Junction to Ambient	51(Note 3)	°C/W

Ordering and Marking Information

Device	Package Type	Device Marking	Reel Size	Tape Width	Quantity
MC4863S	SOP16		13"	16mm	3000 units
MC4863SP	TSSOP16-EP		13"	12mm	3000 units
MC4863M	TSSOP20		13"	12mm	3000 units
MC4863MP	TSSOP20-EP		13"	12mm	3000 units

ESD Susceptibility

ESD Susceptibility-HBM ----- 2kV
ESD Susceptibility-MM ----- 200V

1. Stresses above those listed in Absolute Maximum Ratings may cause permanent damage to the device. Functional operation at conditions other than the operating conditions specified is not implied. Only one Absolute Maximum Rating should be applied at one time.
2. The ThermalPad on the bottom of the IC should soldered directly to the PCB's ThermalPad area that with several thermal vias connect to the ground plan, and the PCB is a 2-layer, 5-inch square area with 2oz copper thickness.



Dual 2.2W Audio Amplifier Plus Stereo Headphone Function

Electrical Characteristics

The following specifications apply for $V_{DD} = 5V$ unless otherwise noted. Limits apply for $T_A = 25^\circ C$.

Symbol	Parameter	Conditions	MC4863		Units (Limits)
			Typical	Limit	
V_{DD}	Supply Voltage			2	V (min)
				5.5	V (max)
I_{DD}	Quiescent Power Supply Current	$V_{IN} = 0V$, No Load, HP-IN= 0V	11.5	20	mA (max)
		$V_{IN} = 0V$, No Load, HP-IN= 4V	5.8	6	mA (min)
I_{SD}	Shutdown Current	$V_{PIN1} = V_{DD}$	0.7	2	uA(min)
V_{IH}	Headphone High Input Voltage			4	V (min)
V_{IL}	Headphone Low Input Voltage			0.8	V (max)

The following specifications apply for $V_{DD} = 5V$ unless otherwise specified. Limits apply for $T_A = 25^\circ C$.

Symbol	Parameter	Conditions	MC4863		Units (Limits)
			Typical	Limit	
V_{OS}	Output Offset Voltage	$V_{IN} = 0V$	5	50	mV (max)
P_O	Output Power (Note6)	THD = 1%, $f = 1$ kHz MC4863MP, $R_L = 3\Omega$ (Note 4)	2.5	1.0	W
		MC4863MP, $R_L = 4\Omega$ (Note 5)	2.2		W
		MC4863, $R_L = 8\Omega$	1.1		W (min)
		THD+N = 10%, $f = 1$ kHz MC4863MP, $R_L = 3\Omega$ (Note 4)	3.2		W
		MC4863MP, $R_L = 4\Omega$ (Note 5)	2.7		W
		MC4863, $R_L = 8\Omega$	1.5		W
		THD+N = 1%, $f = 1$ kHz, $R_L = 32\Omega$	0.34		W
THD+N	Total Harmonic Distortion+Noise	20 Hz < f < 20 kHz, $A_{VD} = 2$ MC4863MP, $R_L = 4\Omega$, $P_o = 2W$ MC4863, $R_L = 8\Omega$, $P_o = 1W$	0.3		%
PSRR	Power Supply Rejection Ratio	$V_{DD} = 5V$, $V_{RIPPLE} = 200mV_{RMS}$, $R_L = 8\Omega$, $C_B = 1.0\mu F$	67		dB
X_{TALK}	Channel Separation	$f = 1$ kHz, $C_B = 1.0\mu F$	90		dB
SNR	Signal To Noise Ratio	$V_{DD} = 5V$, $P_o = 1.1W$, $R_L = 8\Omega$	98		dB

Dual 2.2W Audio Amplifier Plus Stereo Headphone Function

The following specifications apply for $V_{DD} = 5V$ unless otherwise specified. Limits apply for $T_A = 25^\circ C$.

Symbol	Parameter	Conditions	MC4863		Units (Limits)
			Typical	Limit	
V_{OS}	Output Offset Voltage	$V_{IN} = 0V$	5	50	mV (max)
P_O	Output Power	THD = 0.5% , $f = 1\text{ kHz}, R_L = 32\Omega$	85	75	mW (min)
		THD+N = 1%, $f = 1\text{ kHz}, R_L = 8\Omega$	340		mW
		THD+N = 10% , $f = 1\text{ kHz}, R_L = 8\Omega$	440		mW
THD+N	Total Harmonic Distortion+Noise	$A_V = -1, P_O = 75\text{ mW}, 20\text{ Hz} \leq f \leq 20\text{ kHz}, R_L = 32\Omega$	0.2		%
PSRR	Power Supply Rejection Ratio	$C_B = 1.0\mu F, V_{RIPPLE} = 200\text{ mV}_{RMS}, f = 1\text{ kHz}$	52		dB
X_{TALK}	Channel Separation	$f = 1\text{ kHz}, C_B = 1.0\mu F$	60		dB
SNR	Signal To Noise Ratio	$V_{DD} = 5V, P_O = 340\text{ mW}, R_L = 8\Omega$	95		dB

Note 3: The θ_{JA} given is for an TSSOP20-EP package whose exposed-DAP is soldered to an exposed 2 in^2 piece of 1 ounce printed circuit board copper.

Note 4: When driving 3Ω loads from a 5V supply, the MC4863MP must be mounted to the circuit board and forced-air cooled (450 linear-feet per minute).

Note 5: When driving 4Ω loads from a 5V supply, the MC4863MP must be mounted to the circuit board.

Note 6: Output power is measured at the device terminals.

Dual 2.2W Audio Amplifier Plus Stereo Headphone Function

Typical Operating Characteristics(MP)

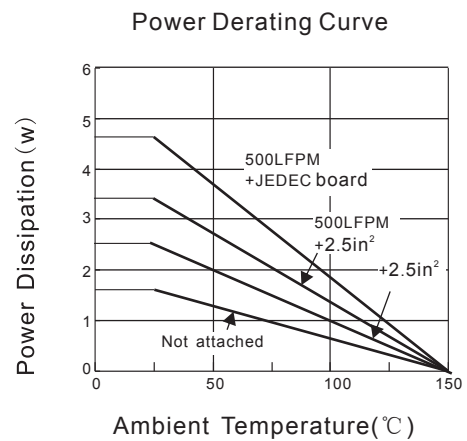
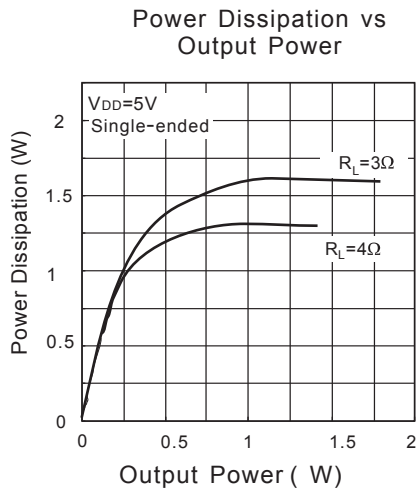
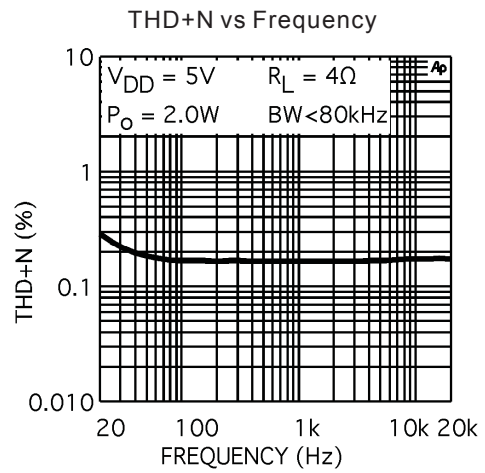
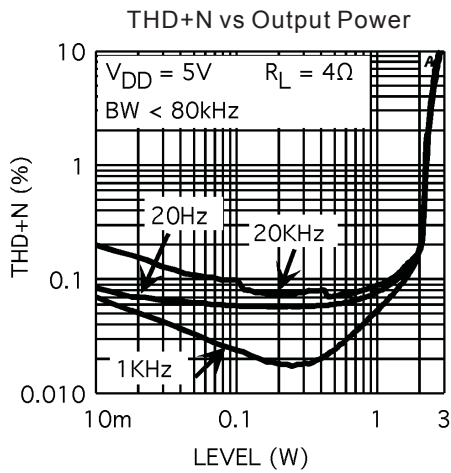
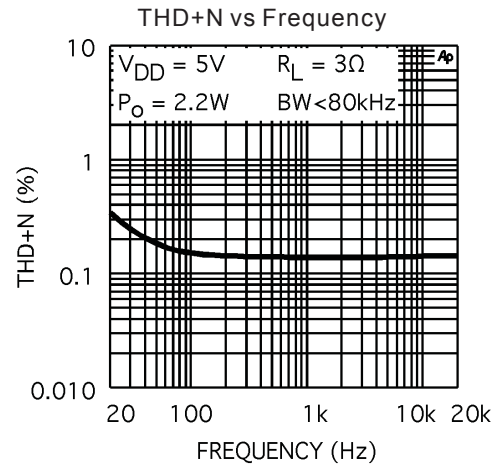
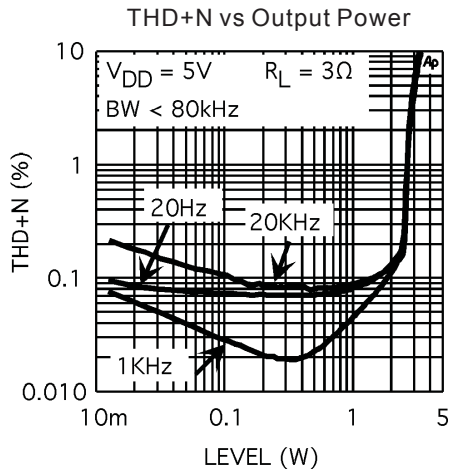

Dual 2.2W Audio Amplifier Plus Stereo Headphone Function

Typical Operating Characteristics(Non-MP)

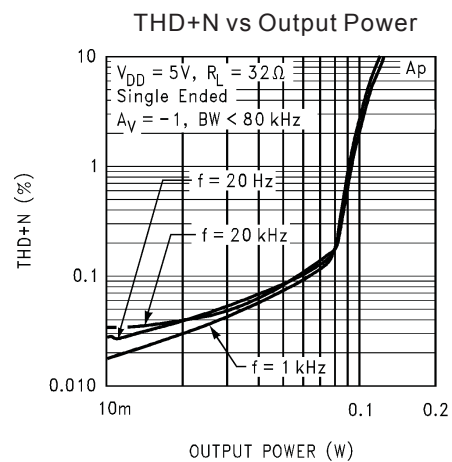
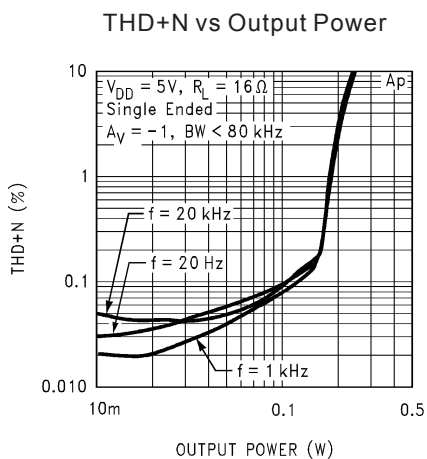
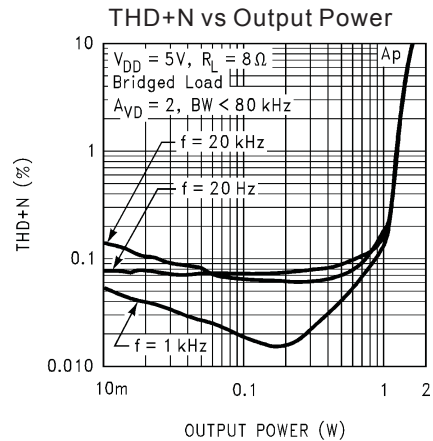
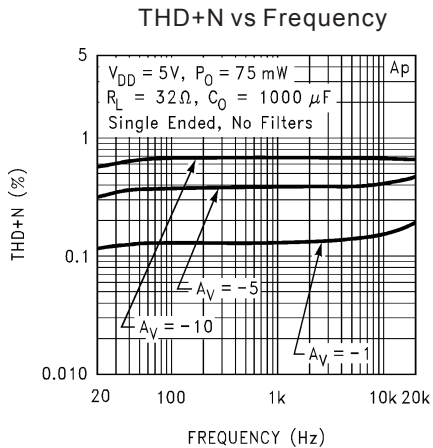
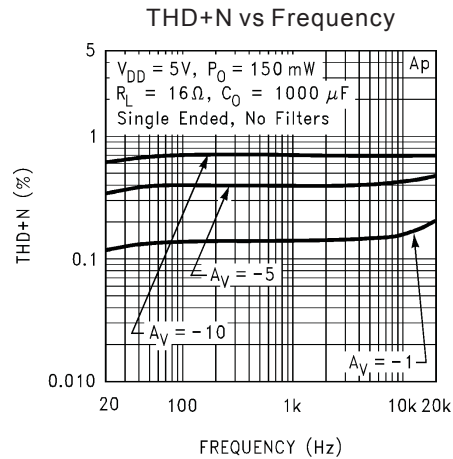
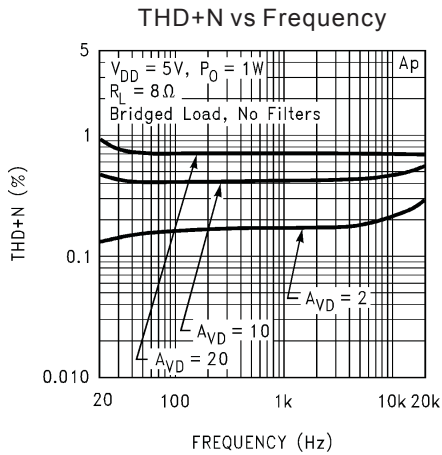

Dual 2.2W Audio Amplifier Plus Stereo Headphone Function

Typical Operating Characteristics

THD+N vs Output Power

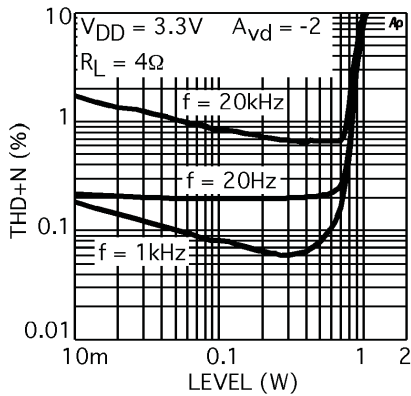

THD+N vs Frequency

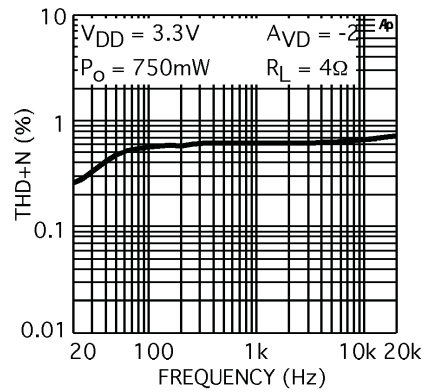

THD+N vs Output Power

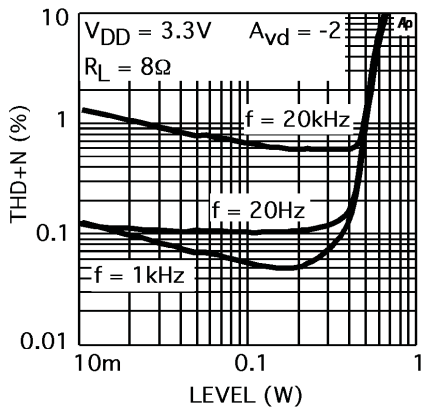

THD+N vs Frequency

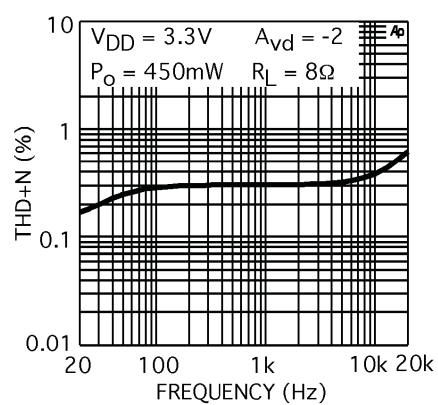

Output Power vs Load Resistance

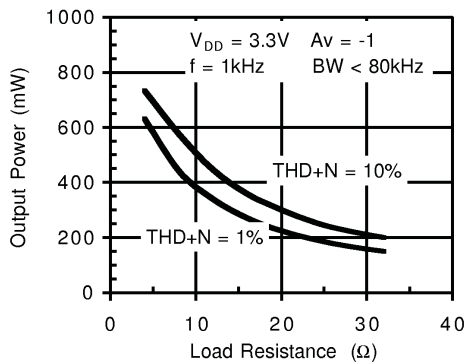

Power Dissipation vs Output Power

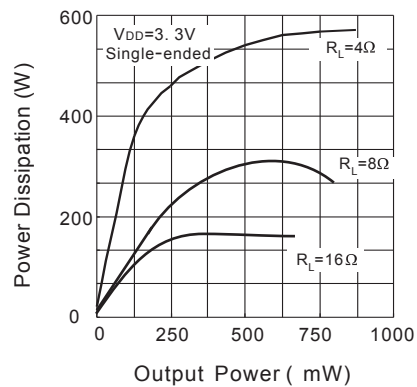

Dual 2.2W Audio Amplifier Plus Stereo Headphone Function

Typical Operating Characteristics

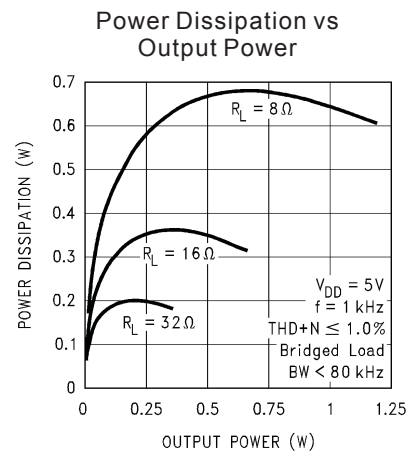
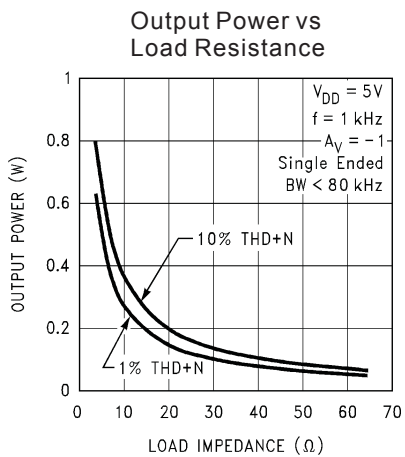
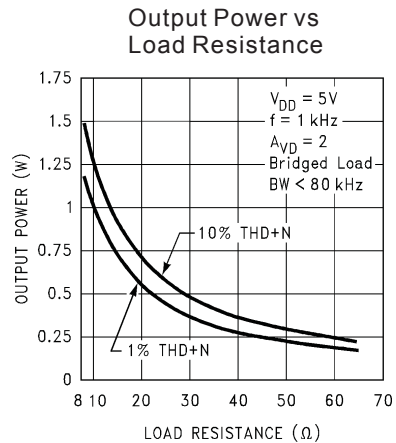
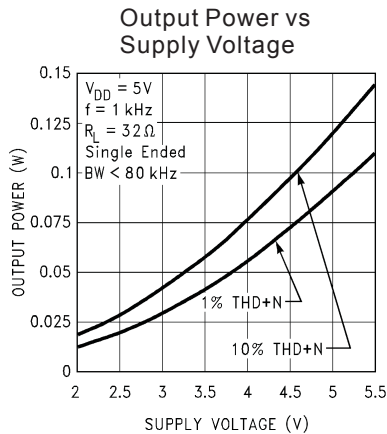
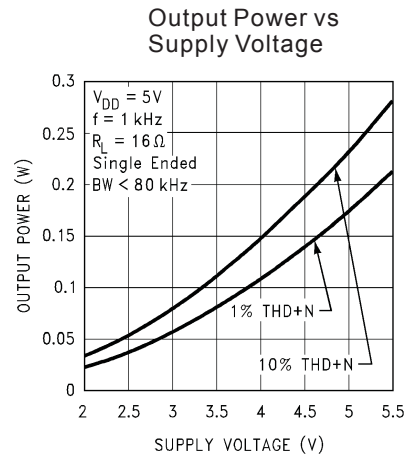
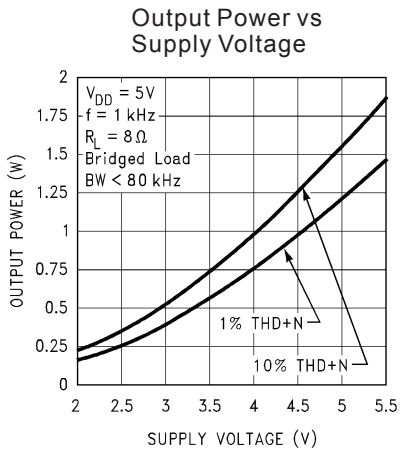

Dual 2.2W Audio Amplifier Plus Stereo Headphone Function

Typical Operating Characteristics

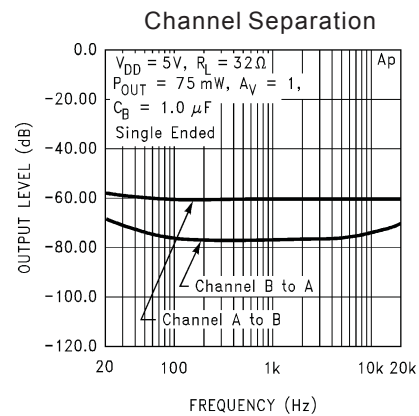
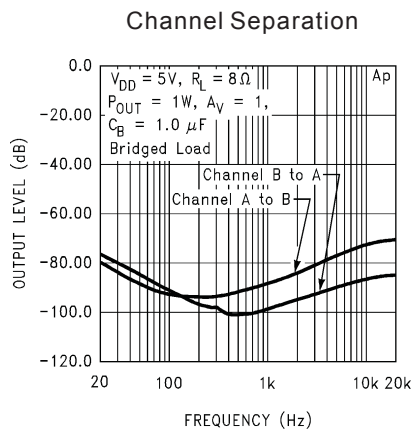
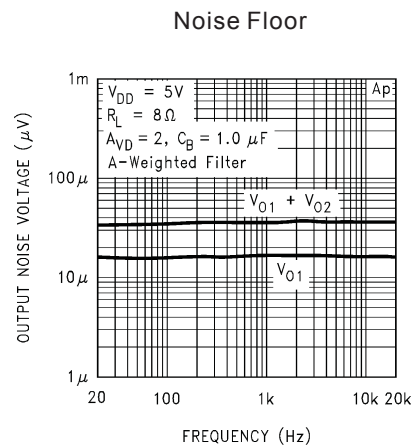
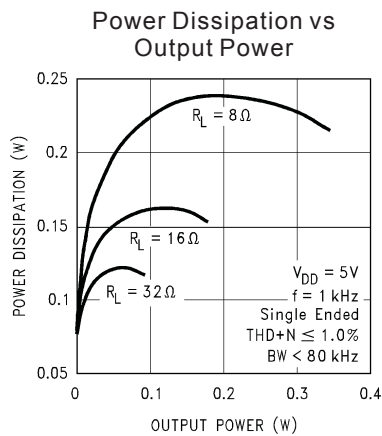
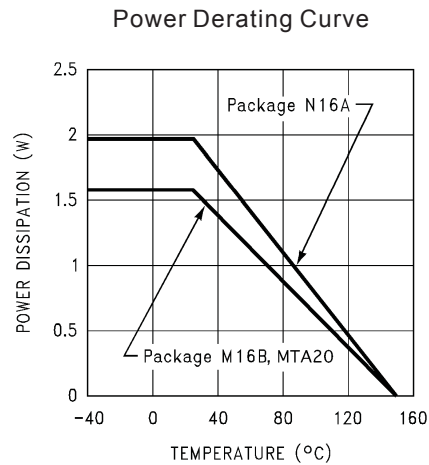
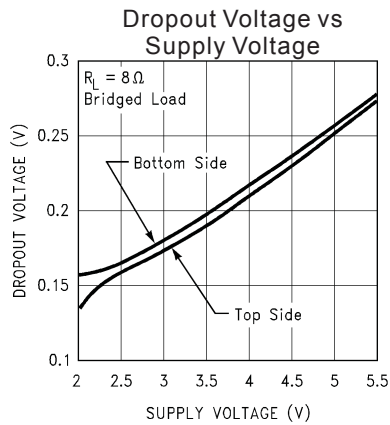



Dual 2.2W Audio Amplifier Plus Stereo Headphone Function

Typical Operating Characteristics

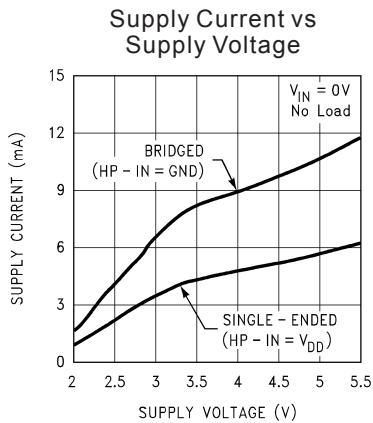
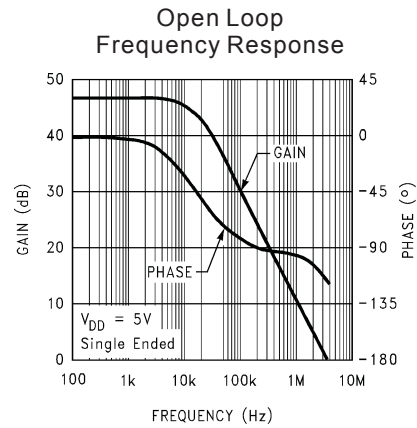
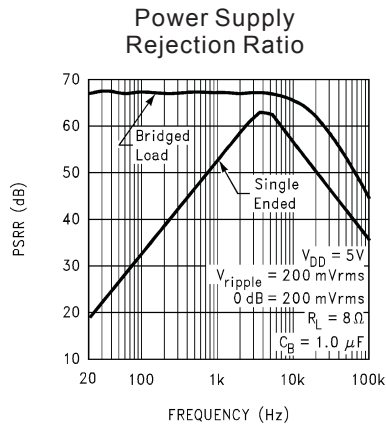

Dual 2.2W Audio Amplifier Plus Stereo Headphone Function

Application Information

Exposed-DAP Mounting Considerations

The exposed-DAP must be connected to ground. The exposed-DAP package of the MC4863 requires special attention to thermal design. If thermal design issues are not properly addressed, an MC4863 driving 4Ω will go into thermal shutdown.

The exposed-DAP on the bottom of the MC4863 should be soldered down to a copper pad on the circuit board. Heat is conducted away from the exposed-DAP by a copper plane. If the copper plane is not on the top surface of the circuit board, 8 to 10 vias of 0.013 inches or smaller in diameter should be used to thermally couple the exposed-DAP to the plane. For good thermal conduction, the vias must be plated-through and solder-filled.

The copper plane used to conduct heat away from the exposed-DAP should be as large as practical. If the plane is on the same side of the circuit board as the exposed-DAP, 2.5in² is the minimum for 5V operation into 4Ω. If the heat sink plane is buried or not on the same side as the exposed-DAP, 5in² is the minimum for 5V operation into 4Ω. If the ambient temperature is higher than 25°C, a larger copper plane or forced-air cooling will be required to keep the MC4863 junction temperature below the thermal shutdown temperature (150°C). See the power derating curve for the MC4863 for derating information.

The MC4863 requires forced-air cooling when operating into 3Ω. With the part attached to 2.5in² of exposed copper, with a 3Ω load, and with an ambient temperature of 25°C, 450 linear-feet per minute kept the part out of thermal shutdown.

In higher ambient temperatures, higher airflow rates and/or larger copper areas will be required to keep the part out of thermal shutdown.

3Ω & 4Ω Layout Considerations

With low impedance loads, the output power at the loads is heavily dependent on trace resistance

from the output pins of the MC4863. Traces from the output of the MC4863 to the load or load connectors should be as wide as practical. Any resistance in the output traces will reduce the power delivered to the load. For example, with a 4Ω load and 0.1Ω of trace resistance in each output, output power at the load drops from 2.2W to 2.0W. Output power is also dependent on supply regulation. To keep the supply voltage from sagging under full output power conditions, the supply traces should be as wide as practical.

Bridge Configuration Explanation

As shown in Figure 1, the MC4863 has two pairs of operational amplifiers internally, allowing for a few different amplifier configurations. The first amplifier's gain is externally configurable, while the second amplifier is internally fixed in a unity-gain, inverting configuration. The closed-loop gain of the first amplifier is set by selecting the ratio of R_f to R_i while the second amplifier's gain is fixed by the two internal 20 kΩ resistors. Figure 1 shows that the output of amplifier one serves as the input to amplifier two which results in both amplifiers producing signals identical in magnitude, but out of phase 180°. Consequently, the differential gain for each channel of the IC is

$$A_{VD} = 2 * (R_f/R_i)$$

By driving the load differentially through outputs +OutA and -OutA or +OutB and -OutB, an amplifier configuration commonly referred to as "bridged mode" is established. Bridged mode operation is different from the classical single-ended amplifier configuration where one side of its load is connected to ground.



Dual 2.2W Audio Amplifier Plus Stereo Headphone Function

A bridge amplifier design has a few distinct advantages over the single-ended configuration, as it provides differential drive to the load, thus doubling the output swing for a specified supply voltage. Four times the output power is possible as compared to a single-ended amplifier under the same conditions. This increase in attainable output power assumes that the amplifier is not current limited or clipped. In order to choose an amplifier's closed-loop gain without causing excessive clipping, please refer to the Audio Power Amplifier Design section.

A bridge configuration, such as the one used in MC4863, also creates a second advantage over single-ended amplifiers. Since the differential outputs, +OutA, -OutA, +OutB, and -OutB, are biased at half-supply, no net DC voltage exists across the load. This eliminates the need for an output coupling capacitor which is required in a single supply, single-ended amplifier configuration. If an output coupling capacitor is not used in a single-ended configuration, the half-supply bias across the load would result in both increased internal IC power dissipation as well as permanent loudspeaker damage.

Power Dissipation

Whether the power amplifier is bridged or single-ended, power dissipation is a major concern when designing the amplifier. Equation 1 states the maximum power dissipation point for a single-ended amplifier operating at a given supply voltage and driving a specified load.

$$P_{DMAX} = (V_{DD})^2 / (2\pi^2 R_L) \quad \text{Single-Ended (1)}$$

However, a direct consequence of the increased power delivered to the load by a bridge amplifier is an increase in internal power dissipation. Equation 2 states the maximum power dissipation point for a bridge amplifier operating at the same given conditions.

$$P_{DMAX} = 4 * (V_{DD})^2 / (2\pi^2 R_L) \quad \text{Bridge Mode (2)}$$

Since the MC4863 is a dual channel power amplifier, the maximum internal power dissipation is 2 times that of Equation 1 or Equation 2 depending on the mode of operation. Even with

this substantial increase in power dissipation, the MC4863 does not require heatsinking. The power dissipation from Equation 2, assuming a 5V power supply and an 8W load, must not be greater than the power dissipation that results from Equation 3:

$$P_{DMAX} = (T_{JMAX} - T_A) / \theta_{JA} \quad (3)$$

For packages SOP16 and TSSOP20, $\theta_{JA} = 80^\circ\text{C/W}$. Depending on the ambient temperature, T_A , of the system surroundings, Equation 3 can be used to find the maximum internal power dissipation supported by the IC packaging. If the result of Equation 2 is greater than that of Equation 3, then either the supply voltage must be decreased, the load impedance increased, or the ambient temperature reduced. For the typical application of a 5V power supply, with an 8Ω bridged load, the maximum ambient temperature possible without violating the maximum junction temperature is approximately 48°C provided that device operation is around the maximum power dissipation point and assuming surface mount packaging. Internal power dissipation is a function of output power. If typical operation is not around the maximum power dissipation point, the ambient temperature can be increased. Refer to the Typical Performance Characteristics curves for power dissipation information for different output powers.

Power Supply Bypassing

As with any power amplifier, proper supply bypassing is critical for low noise performance and high power supply rejection. The capacitor location on both the bypass and power supply pins should be as close to the device as possible. The effect of a larger half supply bypass capacitor is improved PSRR due to increased half-supply stability. Typical applications employ a 5V regulator with 10 μF and a 0.1 μF bypass capacitors which aid in supply filtering. This does not eliminate the



Dual 2.2W Audio Amplifier Plus Stereo Headphone Function

need for bypassing the supply nodes of the MC4863. The selection of bypass capacitors, especially C_B , is thus dependent upon desired PSRR requirements, click and pop performance as explained in the section, Proper Selection of External Components, system cost, and size constraints.

Shutdown Function

In order to reduce power consumption while not in use, the MC4863 contains a shutdown pin to externally turn off the amplifier's bias circuitry. This shutdown feature turns the amplifier off when a logic high is placed on the shutdown pin.

The trigger point between a logic low and logic high level is typically half supply. It is best to switch between ground and the supply V_{DD} to provide maximum device performance. By switching the shutdown pin to V_{DD} , the MC4863 supply current draw will be minimized in idle mode. While the device will be disabled with shutdown pin voltages less than V_{DD} , the idle current may be greater than the typical value of $0.7\mu A$. In either case, the shutdown pin should be tied to a definite voltage to avoid unwanted state changes. In many applications, a microcontroller or microprocessor output is used to control the shutdown circuitry which provides a quick, smooth transition into shutdown. Another solution is to use a single-pole, single-throw switch in conjunction with an external pull-up resistor. When the switch is closed, the shutdown pin is connected to ground and enables the amplifier. If the switch is open, then the external pull-up resistor will disable the MC4863. This scheme guarantees that the shutdown pin will not float, thus preventing unwanted state changes.

HP-IN Function

The MC4863 possesses a headphone control pin that turns off the amplifiers which drive +OutA and +OutB so that single-ended operation can occur and a bridged connected load is mute. Quiescent

Current consumption is reduced when the IC is in this single-ended mode.

Figure 2 shows the implementation of the MC4863's headphone control function using a single-supply headphone amplifier. The voltage divider of R1 and R2 sets the voltage at the HP-IN pin (pin 16) to be approximately 50 mV when there are no headphones plugged into the system. This logic-low voltage at the HP-IN pin enables the MC4863 and places it in bridged mode operation. Resistor R4 limits the amount of current flowing out of the HP-IN pin when the voltage at that pin goes below ground resulting from the music coming from the headphone amplifier. The output coupling capacitors protect the headphones by blocking the amplifier's half supply DC voltage.

When there are no headphones plugged into the system and the IC is in bridged mode configuration, both loads are essentially at a 0V DC potential. Since the HP-IN threshold is set at 4V, even in an ideal situation, the output swing cannot cause a false single-ended trigger.

When a set of headphones are plugged into the system, the contact pin of the headphone jack is disconnected from the signal pin, interrupting the voltage divider set up by resistors R1 and R2. Resistor R1 then pulls up the HP-IN pin, enabling the headphone function. This disables the second side of the amplifier thus muting the bridged speakers. The amplifier then drives the headphones, whose impedance is in parallel with resistors R2 and R3. Resistors R2 and R3 have negligible effect on output drive capability since the typical impedance of headphones are 32Ω . Also shown in Figure 2 are the electrical connections for the headphone jack and plug. A 3-wire plug consists of a Tip, Ring and Sleeve, where the Tip and Ring are signal carrying conductors and the Sleeve is the common ground return. One control pin contact for each headphone jack is sufficient to indicate to control inputs that the user has inserted a plug into a jack and that another mode of operation is desired.

Dual 2.2W Audio Amplifier Plus Stereo Headphone Function

The MC4863 can be used to drive both a pair of bridged 8Ω speakers and a pair of 32Ω headphones without using the HP-IN pin. In this case the HP-IN would not be connected to the headphone jack but to a microprocessor or a switch. By enabling the HP-IN pin, the 8Ω speakers can be muted.

Proper Selection of External Components

Proper selection of external components in applications using integrated power amplifiers is critical to optimize device and system performance. While the MC4863 is tolerant to a variety of external component combinations, consideration to component values must be used to maximize overall system quality.

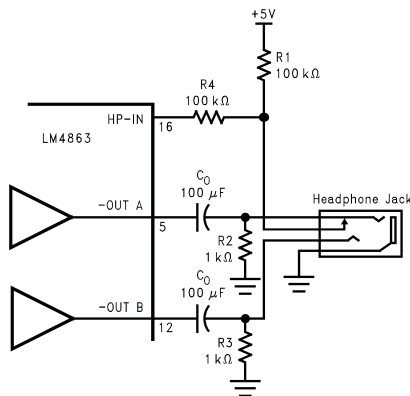

FIGURE 2. Headphone Circuit

The MC4863 is unity-gain stable, giving the designer maximum system performance. The MC4863 should be used in low gain configurations to minimize THD+N values, and maximize the signal to noise ratio. Low gain configurations require large input signals to obtain a given output power. Input signals equal to or greater than 1 Vrms are available from sources such as audio codecs. Please refer to the section, Audio Power Amplifier Design, for a more complete explanation of proper gain selection.

Besides gain, one of the major considerations is the closed-loop bandwidth of the amplifier. To a large extent, the bandwidth is dictated by the choice of external components shown in Figure 1. The input coupling capacitor, C_i , forms a first order high pass filter which limits low frequency response. This value should be chosen based on needed frequency response for a few distinct reasons.

Click and Pop Circuitry

The MC4863 contains circuitry to minimize turn-on transients or “clicks and pops”. In this case, turn-on refers to either power supply turn-on or the device coming out of shutdown mode. When the device is turning on, the amplifiers are internally configured as unity gain buffers. An internal current source ramps up the voltage of the bypass pin. Both the inputs and outputs ideally track the voltage at the bypass pin.

The device will remain in buffer mode until the bypass pin has reached its half supply voltage, $1/2 V_{DD}$. As soon as the bypass node is stable, the device will become fully operational, where the gain is set by the external resistors.

Although the bypass pin current source cannot be modified, the size of C_B can be changed to alter the device turn-on time and the amount of “clicks and pops”. By increasing amount of turn-on pop can be reduced. However, the tradeoff for using a larger bypass capacitor is an increase in turn-on time for this device. There is a linear relationship between the size of C_B and the turn-on time. Here are some typical turn-on times for a given C_B :

C_B	T_{ON}
0.01 μ F	20ms
0.1 μ F	200ms
0.22 μ F	420ms
0.47 μ F	840ms
1.0 μ F	2 Sec



Dual 2.2W Audio Amplifier Plus Stereo Headphone Function

In order to eliminate “clicks and pops”, all capacitors must be discharged before turn-on. Rapid on/off switching of the device or the shutdown function may cause the “click and pop” circuitry to not operate fully, resulting in increased “click and pop” noise. In a single-ended configuration, the output coupling capacitor, C_o , is of particular concern. This capacitor discharges through the internal 20 k Ω resistors. Depending on the size of C_o , the time constant can be relatively large. To reduce transients in single-ended mode, an external 1k Ω –5k Ω resistor can be placed in parallel with the internal 20 k Ω resistor. The tradeoff for using this resistor is an increase in quiescent current.

The value of C_i will also reflect turn-on pops. Clearly, a certain size for C_i is needed to couple in low frequencies without excessive attenuation. But in many cases, the speakers used in portable systems, whether integral or external, have little ability to reproduce signals below 100 Hz to 150 Hz. In this case, using a large input and output capacitor may not increase system performance. In most cases, choosing a small value of C_i in the range of 0.1 μ F to 0.33 μ F, along with C_B equal to 1.0 μ F should produce a virtually clickless and popless turn-on. In cases where C_i is larger than 0.33 μ F, it may be advantageous to increase the value of C_B . Again, it should be understood that increasing the value of C_B will reduce the “clicks and pops” at the expense of a longer device turn-on time.

No-Load Design Considerations

If the outputs of the MC4863 have a load higher than 10k Ω , the MC4863 may show a small oscillation at high output levels. To prevent this oscillation, place 5k Ω resistors from the power outputs to ground.

Audio Power Amplifier Design

Design a 1W/8 Ω Bridged Audio Amplifier

Given:

Power Output: 1 W_{rms}

Load Impedance: 8 Ω

Input Level: 1 V_{rms}

Input Impedance: 20 k Ω

Bandwidth: 100 Hz–20 kHz \pm 0.25 dB

A designer must first determine the minimum supply rail to obtain the specified output power. By extrapolating from the Output Power vs Supply Voltage graphs in the Typical Performance Characteristics section, the supply rail can be easily found. A second way to determine the minimum supply rail is to calculate the required V_{opeak} using Equation 3 and add the dropout voltage. Using this method, the minimum supply voltage would be $(V_{opeak} + (2 \cdot V_{od}))$, where V_{od} is extrapolated from the Dropout Voltage vs Supply Voltage curve in the Typical Performance Characteristics section.

$$V_{opeak} = \sqrt{2R_L P_o} \quad (4)$$

Using the Output Power vs Supply Voltage graph for an 8W load, the minimum supply rail is 3.9V. But since 5V is a standard supply voltage in most applications, it is chosen for the supply rail. Extra supply voltage creates headroom that allows the MC4863 to reproduce peaks in excess of 1W without producing audible distortion. At this time, the designer must make sure that the power supply choice along with the output impedance does not violate the conditions explained in the Power Dissipation section. Once the power dissipation equations have been addressed, the required differential gain can be determined from Equation 4.

$$A_{VD} \geq \sqrt{(P_o R_L) / (V_{IN})^2} = V_{orms} / V_{inrms} \quad (5)$$

$$R_f / R_i = A_{VD} / 2 \quad (6)$$

From equation 4, the minimum A_{VD} is 2.83; use $A_{VD} = 3$. Since the desired input impedance was 20 k Ω , and with a A_{VD} of 3, a ratio of 1.5:1 of R_f to R_i results in an allocation of $R_i = 20$ k Ω and $R_f = 30$ k Ω . The final design step is to Address



Dual 2.2W Audio Amplifier Plus Stereo Headphone Function

The bandwidth requirements which must be stated as a pair of -3 dB frequency points. Five times away from a pole gives 0.17 dB down from passband response, which is better than the required ± 0.25 dB specified.

$$f_L = 100 \text{ Hz}/5 = 20 \text{ Hz}$$

$$f_H = 20 \text{ kHz} \times 5 = 100 \text{ kHz}$$

As stated in the External Components section, R_i in conjunction with C_i create a highpass filter.

$$C_i \geq \frac{1}{2\pi R_i f_c}$$

$$C_i > 1/(2\pi * 20 \text{ kW} * 20 \text{ Hz}) = 0.397 \mu\text{F}; \text{ use } 0.33 \mu\text{F}$$

The high frequency pole is determined by the product of the desired high frequency pole, f_H , and the differential gain, A_{VD} . With a $A_{VD} = 3$ and $f_H = 100 \text{ kHz}$, the resulting GBWP = 150 kHz which is much smaller than the MC4863 GBWP of 3.5 MHz. This figure displays that if a designer has a need to design an amplifier with a higher differential gain, the MC4863 can still be used with-out running into bandwidth problems.

Dual 2.2W Audio Amplifier Plus Stereo Headphone Function

Package Information

SOP16

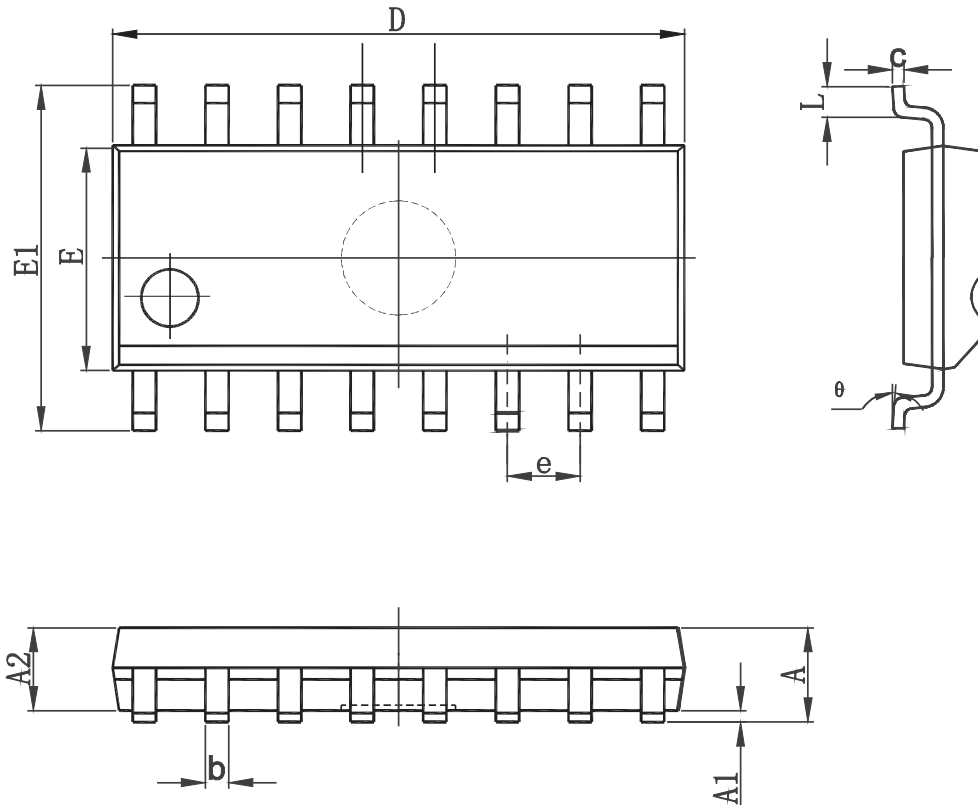

Symbol	Dimensions In Millimeters		Dimensions In Inches	
	Min	Max	Min	Max
A	1.350	1.750	0.053	0.069
A1	0.100	0.250	0.004	0.010
A2	1.350	1.550	0.053	0.061
b	0.330	0.510	0.013	0.020
c	0.170	0.250	0.007	0.010
D	9.800	10.200	0.386	0.402
E	3.800	4.000	0.150	0.157
E1	5.800	6.200	0.228	0.244
e	1.270(BSC)		0.050(BSC)	
L	0.400	1.270	0.016	0.050
q	0°	8°	0°	8°



Dual 2.2W Audio Amplifier Plus Stereo Headphone Function

Package Information

TSSOP16

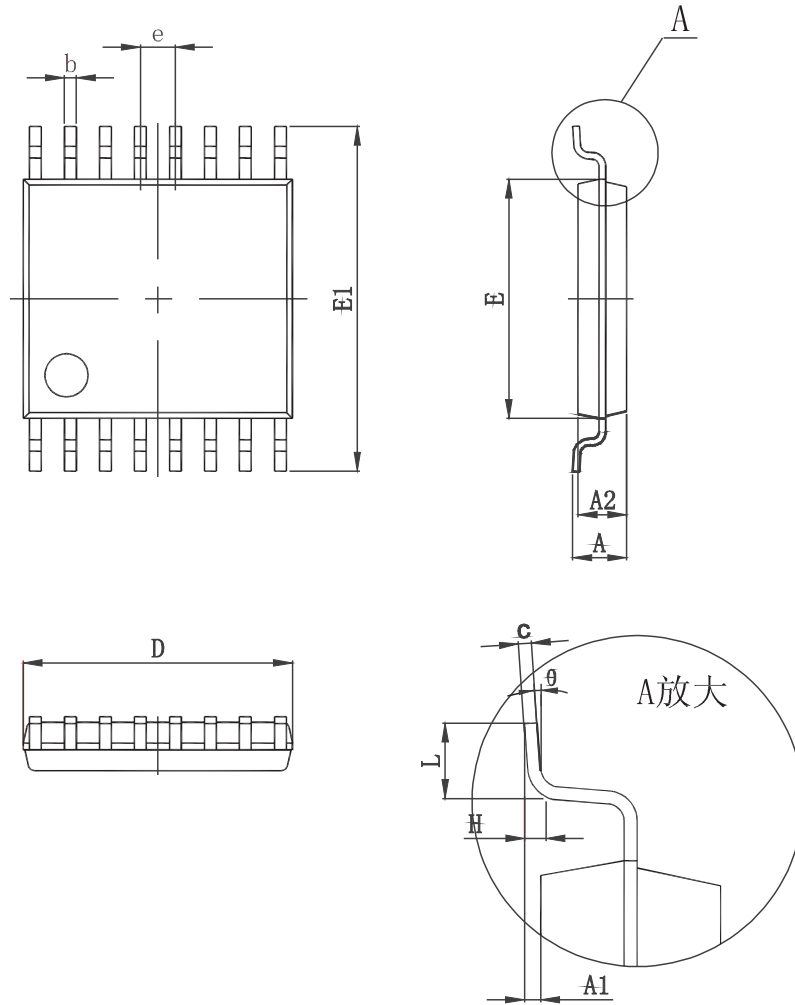

Symbol	Dimensions In Millimeters		Dimensions In Inches	
	Min	Max	Min	Max
D	4.900	5.100	0.193	0.201
E	4.300	4.500	0.169	0.177
b	0.190	0.300	0.007	0.012
c	0.090	0.200	0.004	0.008
E1	6.250	6.550	0.246	0.258
A		1.100		0.043
A2	0.800	1.000	0.031	0.039
A1	0.020	0.150	0.001	0.006
e	0.65 (BSC)		0.026(BSC)	
L	0.500	0.700	0.020	0.028
H	0.25(TYP)		0.01(TYP)	
q	1°	7°	1°	7°

Dual 2.2W Audio Amplifier Plus Stereo Headphone Function

Package Information

TSSOP_20

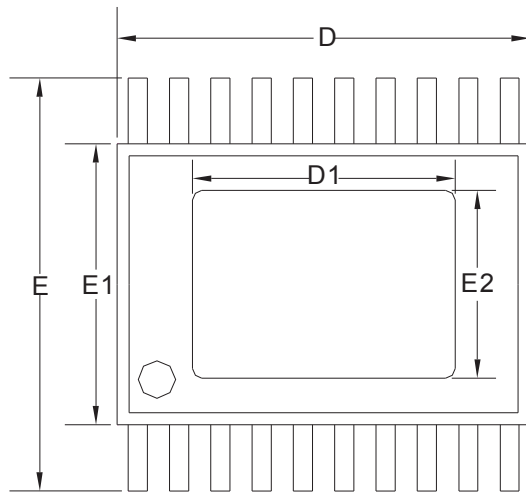

TOP VIEW

Unit: mm

SYMBOL	MIN	NOM	MAX
A	---	---	1.20
A1	0.00	---	0.15
b	0.19	0.24	0.30
E1	4.40		
D	6.50		
D1	4.10		4.30
E	6.20	6.40	6.60
E2	2.90		3.10
e	0.65		
L	0.45	0.60	0.75



SIDE VIEW

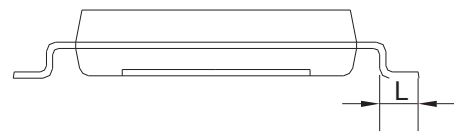

END VIEW

Notes:

- (1) All dimensions are in millimeters. Angles in degrees.
- (2) Package body sizes exclude mold flash and gate burrs.