



QUAD 2-PORT REGISTER

The MC54/74F398 is the logical equivalent of a quad 2-input multiplexer feeding into four edge-triggered flip-flops. A common Select input determines which of the two 4-bit words is accepted. The selected data enters the flip-flops on the rising edge of the clock.

- Select Inputs from Two Data Sources
- Fully Positive Edge-Triggered Operation
- Both True and Complement Outputs

CONNECTION DIAGRAM (TOP VIEW)

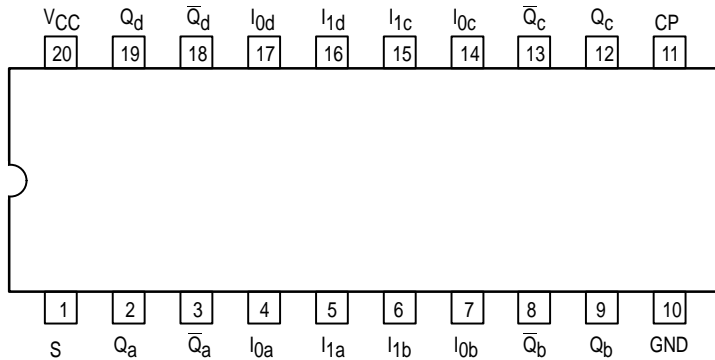

LOGIC DIAGRAM

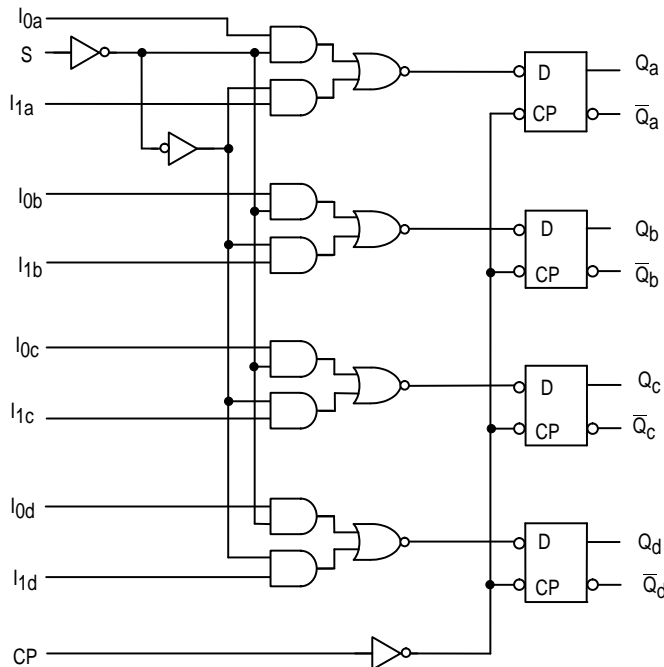

NOTES:
This diagram is provided only for the understanding of logic operations and should not be used to estimate propagation delays.

MC54/74F398

QUAD 2-PORT REGISTER FAST™ SCHOTTKY TTL

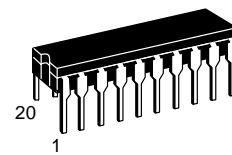

J SUFFIX
CERAMIC
CASE 732-03

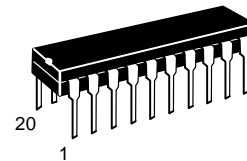

N SUFFIX
PLASTIC
CASE 738-03

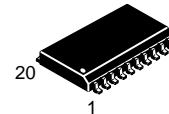

DW SUFFIX
SOIC
CASE 751D-03

ORDERING INFORMATION

MC54FXXXJ Ceramic
MC74FXXXN Plastic
MC74FXXXDW SOIC

LOGIC SYMBOL

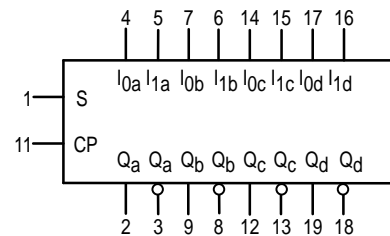

VCC = PIN 20
GND = PIN 10

MC54/74F398

FUNCTIONAL DESCRIPTION

The MC54/74F398 is a high-speed quad 2-port register. It will select four bits of data from either of two sources (Ports) under control of a common Select input (S). The selected data is transferred to a 4-bit output register synchronous with the LOW-to-HIGH transition of the Clock input (CP). The 4-bit D-

type output register is fully edge-triggered. The Data inputs (I_{0x} , I_{1x}) and Select input (S) must be stable only a setup time prior to and hold time after the LOW-to-HIGH transition of the Clock input for predictable operation. The MC54/74F398 has both Q and \bar{Q} outputs.

FUNCTION TABLE

Inputs			Outputs	
S	I_0	I_1	Q	\bar{Q}
l	l	X	L	H
l	h	X	H	L
h	X	l	L	H
h	X	h	H	L

H = HIGH Voltage Level

L = LOW Voltage Level

h = HIGH Voltage Level one setup time prior to the LOW-to-HIGH clock transition

l = LOW Voltage Level; one setup time prior to the LOW-to-HIGH clock transition

X = Don't Care

GUARANTEED OPERATING RANGES

Symbol	Parameter		Min	Typ	Max	Unit
V_{CC}	Supply Voltage	54, 74	4.5	5.0	5.5	V
T_A	Operating Ambient Temperature Range	54	-55	25	125	°C
		74	0	25	70	
I_{OH}	Output Current – High	54, 74			-1.0	mA
I_{OL}	Output Current – Low	54, 74			20	mA

DC CHARACTERISTICS OVER OPERATING TEMPERATURE RANGE (unless otherwise specified)

Symbol	Parameter	Limits			Unit	Test Conditions	
		Min	Typ	Max			
V_{IH}	Input HIGH Voltage	2.0			V	Guaranteed Input HIGH Voltage	
V_{IL}	Input LOW Voltage			0.8	V	Guaranteed Input LOW Voltage	
V_{IK}	Input Clamp Diode Voltage			-1.2	V	$I_{IN} = -18$ mA	$V_{CC} = \text{MIN}$
V_{OH}	Output HIGH Voltage	54, 74	2.5	3.4	V	$I_{OH} = -1.0$ mA	$V_{CC} = 4.5$ V
		74	2.7	3.4	V	$I_{OH} = -1.0$ mA	$V_{CC} = 4.75$ V
V_{OL}	Output LOW Voltage		0.35	0.5	V	$I_{OL} = 20$ mA	$V_{CC} = \text{MIN}$
I_{IH}	Input HIGH Current			20	μ A	$V_{IN} = 2.7$ V	$V_{CC} = \text{MAX}$
				100	μ A	$V_{IN} = 7.0$ V	
I_{IL}	Input LOW Current			-0.6	mA	$V_{IN} = 0.5$ V	$V_{CC} = \text{MAX}$
I_{OS}	Output Short Circuit Current (Note 2)	-60		-150	mA	$V_{OUT} = 0$ V	$V_{CC} = \text{MAX}$
I_{CC}	Power Supply Current		25	38	mA	$V_{CC} = \text{MAX}$	$V_{IN} = \text{GND}$ CP = 

NOTES:

- For conditions shown as MIN or MAX, use the appropriate value specified under guaranteed operating ranges.
- Not more than one output should be shorted at a time, nor for more than 1 second.

MC54/74F398

AC CHARACTERISTICS

Symbol	Parameter	54/74F			54F		74F		Unit
		T _A = +25°C V _{CC} = +5.0 V C _L = 50 pF			T _A = -55°C to +125°C V _{CC} = 5.0 V ±10% C _L = 50 pF		T _A = -0°C to 70°C V _{CC} = 5.0 V ±10% C _L = 50 pF		
		Min	Typ	Max	Min	Max	Min	Max	
f _{max}	Maximum Clock Frequency	100	140		80		100		MHz
t _{PLH}	Propagation Delay	3.0	5.7	7.5	3.0	9.5	3.0	8.5	ns
t _{PHL}	CP to Q or \bar{Q}	3.0	6.8	9.5	3.0	11.5	3.0	10.0	

AC OPERATING REQUIREMENTS

Symbol	Parameter	54/74F			54F		74F		Unit
		T _A = +25°C V _{CC} = +5.0V			T _A = -55°C to +125°C V _{CC} = 5.0 V ±10%		T _A = -0°C to 70°C V _{CC} = 5.0 V ±10%		
		Min	Typ	Max	Min	Max	Min	Max	
t _S (H)	Setup Time, HIGH or LOW	3.0			4.5		3.0		ns
t _S (L)	I _n to CP	3.0			4.5		3.0		
t _H (H)	Hold Time, HIGH or LOW	1.0			1.5		1.0		ns
t _H (L)	I _n to CP	1.0			1.5		1.0		
t _S (H)	Setup Time, HIGH or LOW	7.5			10.5		8.5		ns
t _S (L)	S to CP	7.5			10.5		8.5		
t _H (H)	Hold Time, HIGH or LOW	0			0		0		ns
t _H (L)	S to CP	0			0		0		
t _w (H)	CP Pulse Width	4.0			4.0		4.0		ns
t _w (L)	HIGH or LOW	5.0			7.0		5.0		