

MC68HC11ED0

Technical Summary

HCMOS
Microcontroller Unit



MC68HC11ED0

Technical Summary

List of Sections

www.DataSheet4U.com

Section 1. General Description15

Section 2. Pin Assignments19

Section 3. Central Processor Unit (CPU)23

Section 4. Operating Modes and On-Chip Memory43

Section 5. Resets and Interrupts57

Section 6. Parallel Input/Output (I/O) Ports65

Section 7. Serial Communications Interface (SCI).71

Section 8. Serial Peripheral Interface (SPI).81

Section 9. Timing System.87

Freescale Semiconductor, Inc.

Table of Contents

www.DataSheet4U.com

Section 1. General Description

1.1 Contents 15

1.2 Introduction 15

1.3 Features 16

1.4 Structure 17

1.5 Ordering Information 18

Section 2. Pin Assignments

2.1 Contents 19

2.2 Introduction 19

2.3 44-Pin Plastic-Leaded Chip Carrier (PLCC) 20

2.4 44-Pin Quad Flat Pack (QFP) 21

2.5 40-Pin Plastic Dual In-Line Package (DIP) 22

Section 3. Central Processor Unit (CPU)

3.1 Contents 23

3.2 Introduction 24

3.3 CPU Registers 24

3.3.1 Accumulators A, B, and D 25

3.3.2 Index Register X (IX) 26

3.3.3 Index Register Y (IY) 26

3.3.4 Stack Pointer (SP) 26

3.3.5 Program Counter (PC) 28

3.3.6	Condition Code Register (CCR)	29
3.3.6.1	Carry/Borrow (C)	29
3.3.6.2	Overflow (V)	29
3.3.6.3	Zero (Z)	29
3.3.6.4	Negative (N)	30
3.3.6.5	I-Interrupt Mask (I)	30
3.3.6.6	Half Carry (H)	30
3.3.6.7	X-Interrupt Mask (X)	30
3.3.6.8	STOP Disable (S)	31
3.4	Data Types	31
3.5	Opcodes and Operands	31
3.6	Addressing Modes	32
3.6.1	Immediate	32
3.6.2	Direct	33
3.6.3	Extended	33
3.6.4	Indexed	33
3.6.5	Inherent	33
3.6.6	Relative	34
3.7	Instruction Set	34

Section 4. Operating Modes and On-Chip Memory

4.1	Contents	43
4.2	Introduction	43
4.3	Operating Modes	44
4.3.1	Bootstrap Mode	44
4.3.2	Special Test Mode	44
4.3.3	Expanded Operating Mode	45
4.4	Mode Selection	46
4.5	On-Chip Memory	48
4.5.1	Memory Map and Register Block	49
4.5.2	RAM	56

Section 5. Resets and Interrupts

5.1 Contents 57

5.2 Introduction 57

5.3 Resets 57

5.4 System Configuration Options Register 60

5.5 Arm/Reset COP Timer Circuitry Register 61

5.6 Configuration Control Register 62

5.7 Highest Priority I-Bit Interrupt and Miscellaneous Register . . . 63

Section 6. Parallel Input/Output (I/O) Ports

6.1 Contents 65

6.2 Introduction 65

6.3 Port A Data Register 66

6.4 Pulse Accumulator Control Register 67

6.5 Port D Data Register 68

6.6 Port D Data Direction Register 69

Section 7. Serial Communications Interface (SCI)

7.1 Contents 71

7.2 Introduction 71

7.3 SCI Registers 74

7.3.1 Baud Rate Register 74

7.3.2 Serial Communications Control Register 1 77

7.3.3 Serial Communications Control Register 2 78

7.3.4 Serial Communication Status Register 79

7.3.5 Serial Communications Data Register 80

Section 8. Serial Peripheral Interface (SPI)

8.1 Contents 81

8.2 Introduction 81

8.3 SPI Registers 83

8.3.1 Serial Peripheral Control Register 83

8.3.2 Serial Peripheral Status Register 85

8.3.3 Serial Peripheral Data I/O Register 86

Section 9. Timing System

9.1 Contents 87

9.2 Introduction 88

9.3 Timer Registers 91

9.3.1 Timer Compare Force Register 91

9.3.2 Output Compare 1 Mask Register 92

9.3.3 Output Compare 1 Data Register 92

9.3.4 Timer Count Register 93

9.3.5 Timer Input Capture Registers 94

9.3.6 Timer Output Compare Registers 95

9.3.7 Timer Input Capture 4/Output Compare 5 Register 96

9.3.8 Timer Control Register 1 97

9.3.9 Timer Control Register 2 98

9.3.10 Timer Interrupt Mask 1 Register 99

9.3.11 Timer Interrupt Flag 1 Register 100

9.3.12 Timer Interrupt Mask 2 Register 100

9.3.13 Timer Interrupt Flag Register 2 102

9.4 Pulse Accumulator 103

9.4.1 Pulse Accumulator Control Register 104

9.4.2 Pulse Accumulator Counter Register 106

List of Figures www.DataSheet4U.com

Figure	Title	Page
1-1	MC68HC11ED0 Block Diagram	17
2-1	Pin Assignments for 44-Pin PLCC	20
2-2	Pin Assignments for 44-Pin QFP	21
2-3	Pin Assignments for 40-Pin DIP	22
3-1	Programming Model	25
3-2	Stacking Operations	27
4-1	Address and Data Demultiplexing	46
4-2	Highest Priority I-Bit Interrupt and Miscellaneous Register (HPRIO)	47
4-3	MC68HC11ED0 Memory Map	49
4-4	Register and Control Bit Assignments	50
4-5	RAM and Register Mapping Register (INIT)	56
5-1	System Configuration Options Register (OPTION)	60
5-2	Arm/Reset COP Timer Circuitry Register (COPRST)	61
5-3	System Configuration Register (CONFIG)	62
5-4	Highest Priority I-Bit Interrupt and Miscellaneous Register (HPRIO)	63
6-1	Port A Data Register (PORTA)	66
6-2	Pulse Accumulator Control Register (PACTL)	67
6-3	Port D Data Register (PORTD)	68
6-4	Port D Data Direction Register (DDRD)	69
7-1	SCI Transmitter Block Diagram	72
7-2	SCI Receiver Block Diagram	73

Figure	Title	Page
7-3	Baud Rate Register (BAUD)	74
7-4	SCI Baud Rate Generator Clock Diagram	76
7-5	Serial Communications Control Register 1 (SCCR1)	77
7-6	Serial Communications Control Register 2 (SCCR2)	78
7-7	Serial Communications Status Register (SCSR)	79
7-8	Serial Communications Data Register (SCDR)	80
8-1	SPI Block Diagram	82
8-2	Serial Peripheral Control Register (SPCR)	83
8-3	SPI Transfer Format	84
8-4	Serial Peripheral Status Register (SPSR)	85
8-5	Serial Peripheral Data I/O Register (SPDR)	86
9-1	Timer Block Diagram	90
9-2	Timer Compare Force Register (CFORC)	91
9-3	Output Compare 1 Mask Register (OC1M)	92
9-4	Output Compare 1 Data Register (OC1D)	92
9-5	Timer Count Register (TCNT)	93
9-6	Timer Input Capture Register 1 (TIC1)	94
9-7	Timer Input Capture Register 2 (TIC2)	94
9-8	Timer Input Capture Register 3 (TIC3)	94
9-9	Timer Output Compare Register 1 (TOC1)	95
9-10	Timer Output Compare Register 2 (TOC2)	95
9-11	Timer Output Compare Register 3 (TOC3)	95
9-12	Timer Output Compare Register 4 (TOC4)	96
9-13	Timer Input Capture4/Output Compare 5 Register (TI4/O5)	96
9-14	Timer Control Register 1 (TCTL1)	97
9-15	Timer Control Register 2 (TCTL2)	98
9-16	Timer Interrupt Mask 1 Register (TMSK1)	99
9-17	Timer Interrupt Flag 1 Register (TFLG1)	100
9-18	Timer Interrupt Mask 2 Register (TMSK2)	100
9-19	Timer Interrupt Flag 2 Register (TFLG2)	102
9-20	Pulse Accumulator System Block Diagram	103
9-21	Pulse Accumulator Control Register (PACTL)	104
9-22	Pulse Accumulator Counter Register (PACNT)	106

List of Tables

Table	Title	Page
1-1	Device Ordering Information	18
3-1	Reset Vector Comparison	28
3-2	Instruction Set	35
5-1	Interrupt and Reset Vector Assignments	59
5-2	COP Timer Rate Select	61
5-3	Highest Priority Interrupt Selection	64
6-1	Input/Output Ports	65
7-1	Prescaler Rates	74
7-2	Baud Rates	75
8-1	SPI Clock Rate Selects	84
9-1	Timer Summary	89
9-2	Timer Output Compare Actions	97
9-3	Timer Control Configuration	98
9-4	Timer Prescale	101
9-5	Pulse Accumulator Timing	104
9-6	RTI Rates (Period Length)	105
9-7	RTI Rates (Frequency)	105

Freescale Semiconductor, Inc.

Section 1. General Description

www.DataSheet4U.com

1.1 Contents

1.2	Introduction	15
1.3	Features	16
1.4	Structure	17
1.5	Ordering Information	18

1.2 Introduction

The MC68HC11ED0 is a low-cost member of the M68HC11 Family of microcontrollers (MCU). This MCU has a multiplexed address/data bus and is characterized by high speed and low-power consumption. The fully static design allows operation at frequencies from 3 MHz to dc.

Pin count is minimized for cost-sensitive applications. Because there is no on-chip read-only memory (ROM), this device is optimized for expanded-bus systems. On-chip serial peripheral interface (SPI) and serial communications interface (SCI) provide a convenient means of transferring data to and from internal random-access memory (RAM). Refer to [Figure 1-1](#).

1.3 Features

Features include:

- M68HC11 CPU
- Power-saving stop and wait modes
- 512 bytes of RAM
- Multiplexed address and data buses
- Enhanced 16-bit timer with 4-stage programmable prescaler
 - Three input capture (IC) channels
 - Four output compare (OC) channels
 - One additional channel, selectable as fourth IC or fifth OC
- 8-bit pulse accumulator
- Real-time interrupt circuit
- Computer operating properly (COP) watchdog
- Clock monitor
- Enhanced asynchronous non-return-to-zero (NRZ) SCI
- Enhanced SPI
- Eight bidirectional input/output (I/O) lines
- Three input-only lines
- Three output-only lines (one output-only line in 40-pin package)
- Packaging options:
 - 44-pin plastic-leaded chip carrier (PLCC)
 - 44-pin quad flat pack (QFP)
 - 40-pin plastic dual in-line package (DIP)

www.DataSheet4U.com

1.4 Structure

See [Figure 1-1](#) for a block diagram of the MC68HC11ED0 MCU.

www.DataSheet4U.com

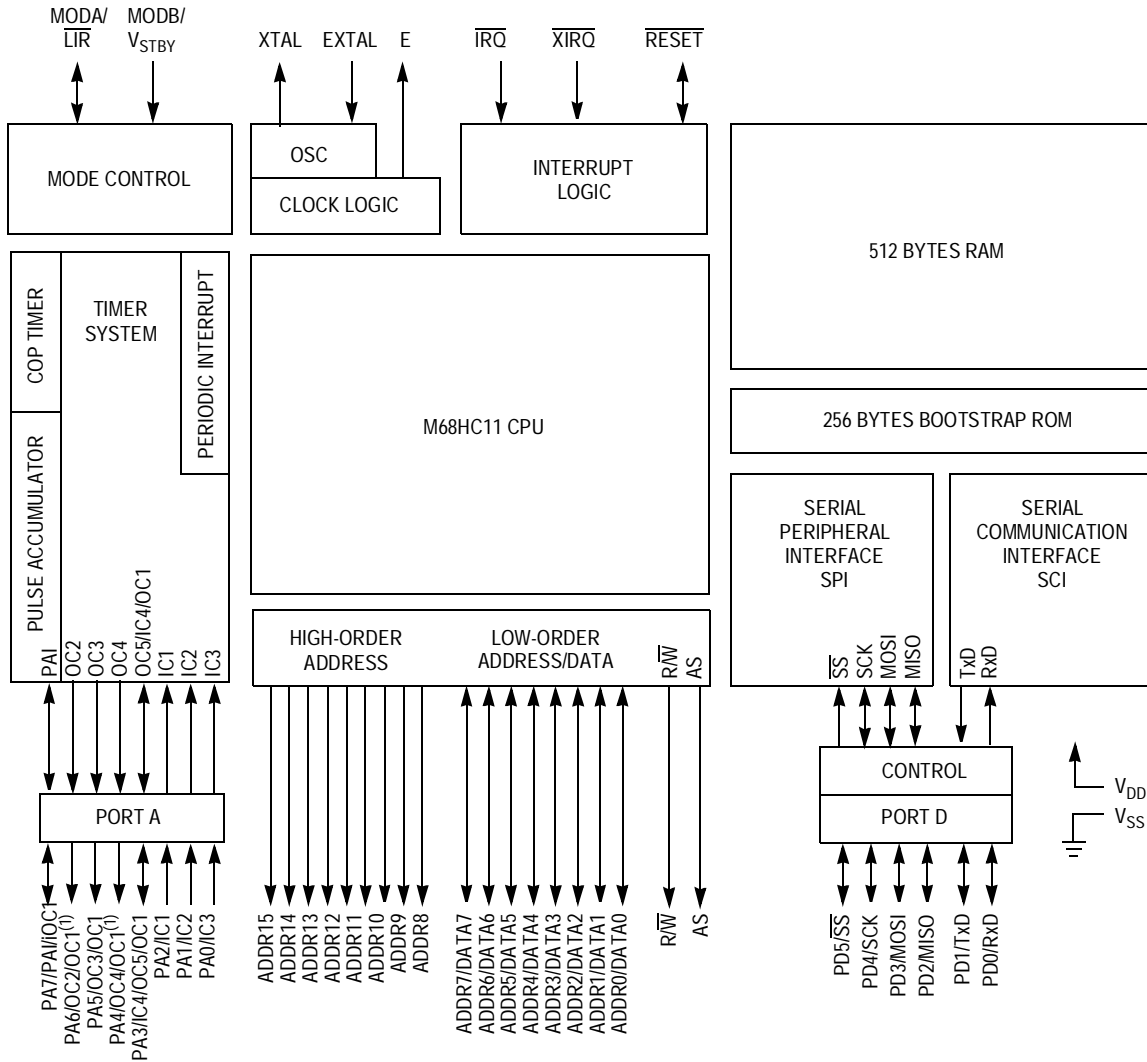

Note 1. Not bonded in 40-pin package

Figure 1-1. MC68HC11ED0 Block Diagram

General Description

1.5 Ordering Information

Table 1-1 provides ordering information for the MC68HC11ED0. Refer to Section 2. Pin Assignments.

www.DataSheet4U.com

Table 1-1. Device Ordering Information

Package	Temperature	Description	Frequency	MC Order Number
44-pin PLCC	-40°C to +85°C	No ROM/EPROM No EEPROM 512 bytes RAM	2 MHz	MC68HC11ED0CFN2
			3 MHz	MC68HC11ED0CFN3
	-40°C to +105°C		2 MHz	MC68HC11ED0VFN2
			3 MHz	MC68HC11ED0VFN3
	-40°C to +125°C		2 MHz	MC68HC11ED0MFN2
			3 MHz	MC68HC11ED0MFN3
44-pin QFP	-40°C to +85°C	No ROM/EPROM No EEPROM 512 bytes RAM	2 MHz	MC68HC11ED0CFU2
			3 MHz	MC68HC11ED0CFU3
	-40°C to +105°C		2 MHz	MC68HC11ED0VFU2
			3 MHz	MC68HC11ED0VFU3
	-40°C to +125°C		2 MHz	MC68HC11ED0MFU2
			3 MHz	MC68HC11ED0MFU3
44-pin DIP	-40°C to +85°C	No ROM/EPROM No EEPROM 512 bytes RAM	2 MHz	MC68HC11ED0CP2
			3 MHz	MC68HC11ED0CP3
	-40°C to +105°C		2 MHz	MC68HC11ED0VP2
			3 MHz	MC68HC11ED0VP3
	-40°C to +125°C		2 MHz	MC68HC11ED0MP2
			3 MHz	MC68HC11ED0MP3

Section 2. Pin Assignments

www.DataSheet4U.com

2.1 Contents

2.2	Introduction	19
2.3	44-Pin Plastic-Leaded Chip Carrier (PLCC)	20
2.4	44-Pin Quad Flat Pack (QFP)	21
2.5	40-Pin Plastic Dual In-Line Package (DIP)	22

2.2 Introduction

The MC68HC11ED0 pin assignments are shown here for these packages:

- 44-pin plastic-leaded chip carrier (PLCC)
- 44-pin quad flat pack (QFP)
- 40-pin plastic dual in-line package (DIP)

Pin Assignments

2.3 44-Pin Plastic-Leaded Chip Carrier (PLCC)

Refer to **Figure 2-1** for the 44-pin PLCC pin assignments.

www.DataSheet4U.com

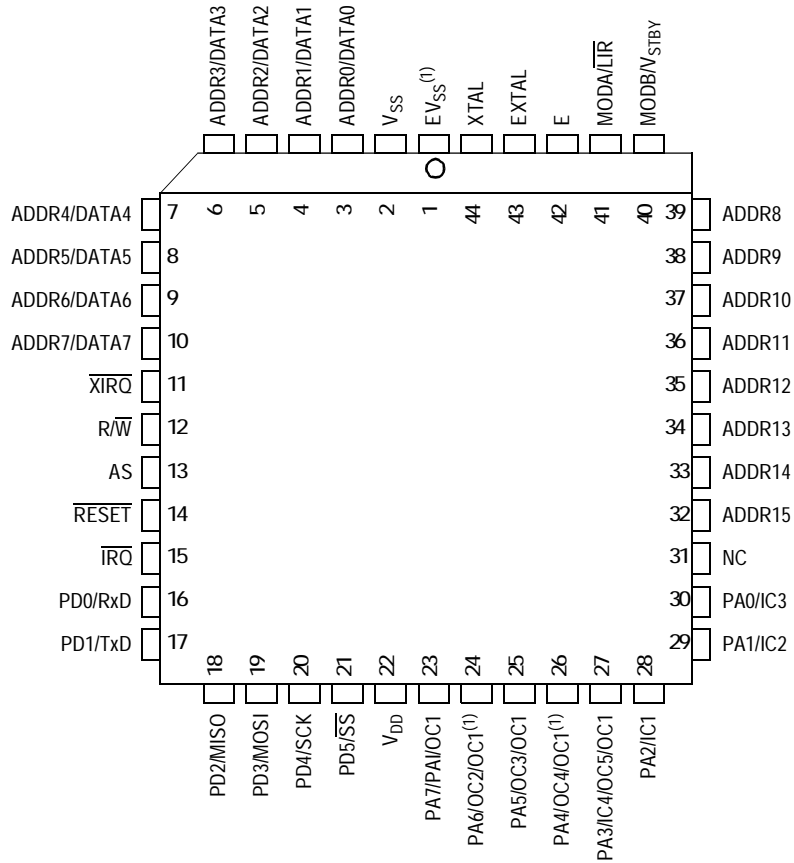

Note 1. Not bonded in 40-pin package

Figure 2-1. Pin Assignments for 44-Pin PLCC

2.4 44-Pin Quad Flat Pack (QFP)

Refer to [Figure 2-2](#) for the 44-pin QFP pin assignments.

www.DataSheet4U.com

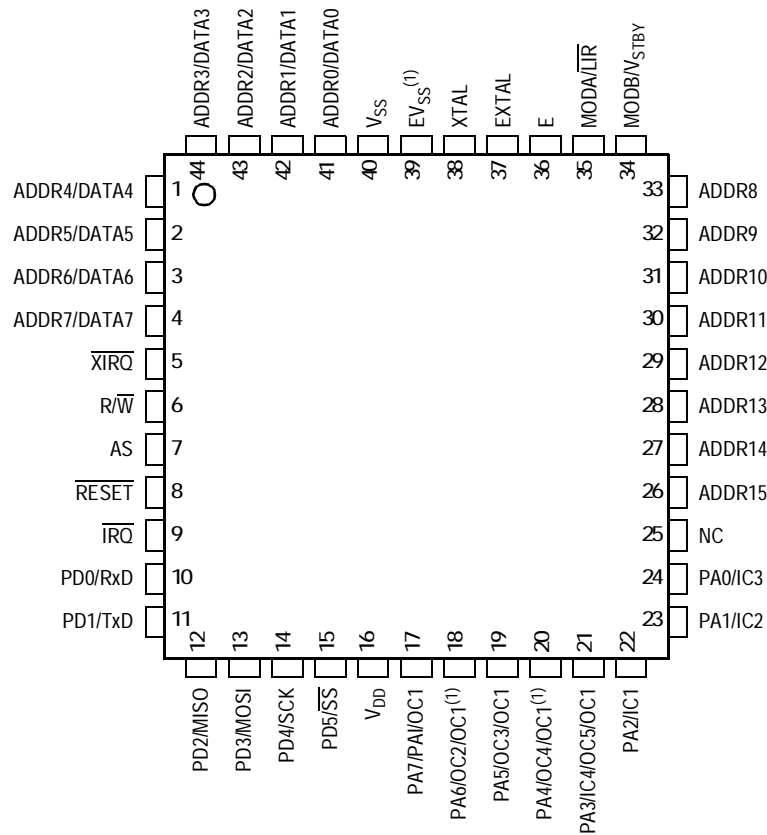

Note 1. Not bonded in 40-pin package

Figure 2-2. Pin Assignments for 44-Pin QFP

2.5 40-Pin Plastic Dual In-Line Package (DIP)

Refer to [Figure 2-3](#) for the 40-pin DIP pin assignments.

www.DataSheet4U.com

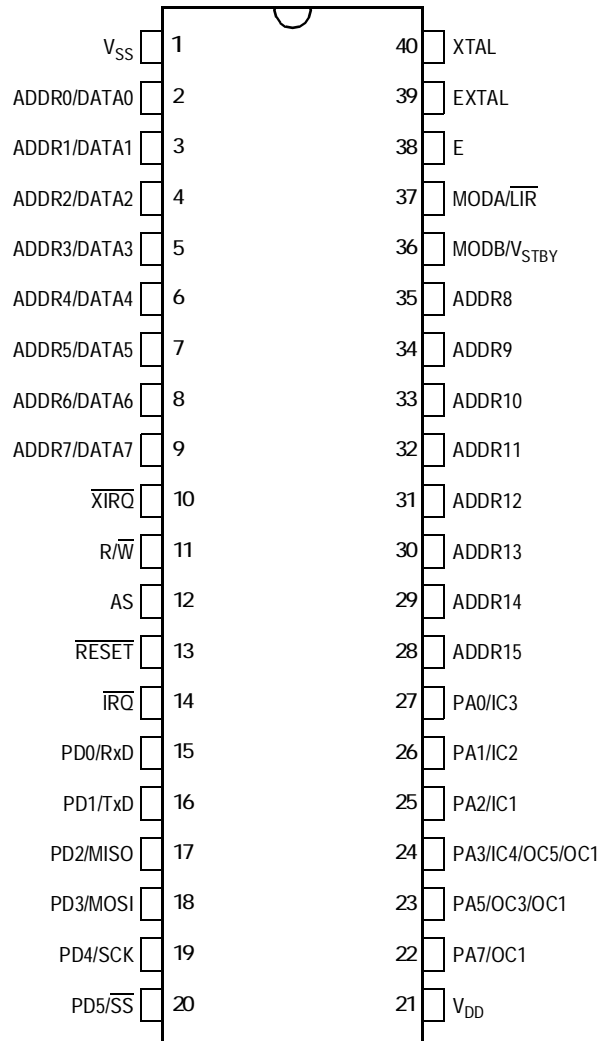

Figure 2-3. Pin Assignments for 40-Pin DIP

Section 3. Central Processor Unit (CPU)

www.DataSheet4U.com

3.1 Contents

3.2	Introduction	24
3.3	CPU Registers	24
3.3.1	Accumulators A, B, and D	25
3.3.2	Index Register X (IX)	26
3.3.3	Index Register Y (IY)	26
3.3.4	Stack Pointer (SP)	26
3.3.5	Program Counter (PC)	28
3.3.6	Condition Code Register (CCR)	29
3.3.6.1	Carry/Borrow (C)	29
3.3.6.2	Overflow (V)	29
3.3.6.3	Zero (Z)	29
3.3.6.4	Negative (N)	30
3.3.6.5	I-Interrupt Mask (I)	30
3.3.6.6	Half Carry (H)	30
3.3.6.7	X-Interrupt Mask (X)	30
3.3.6.8	STOP Disable (S)	31
3.4	Data Types	31
3.5	Opcodes and Operands	31
3.6	Addressing Modes	32
3.6.1	Immediate	32
3.6.2	Direct	33
3.6.3	Extended	33
3.6.4	Indexed	33
3.6.5	Inherent	33
3.6.6	Relative	34
3.7	Instruction Set	34

3.2 Introduction

This section presents information on M68HC11:

- Central processor unit (CPU) architecture
- Data types
- Addressing modes
- Instruction set
- Special operations such as subroutine calls and interrupts

www.DataSheet4U.com

The CPU is designed to treat all peripheral, input/output (I/O), and memory locations identically as addresses in the 64-Kbyte memory map. This is referred to as memory-mapped I/O. I/O has no instructions separate from those used by memory. This architecture also allows accessing an operand from an external memory location with no execution time penalty.

3.3 CPU Registers

M68HC11 CPU registers are an integral part of the CPU and are not addressed as if they were memory locations. The seven registers, discussed in the following paragraphs, are shown in [Figure 3-1](#).

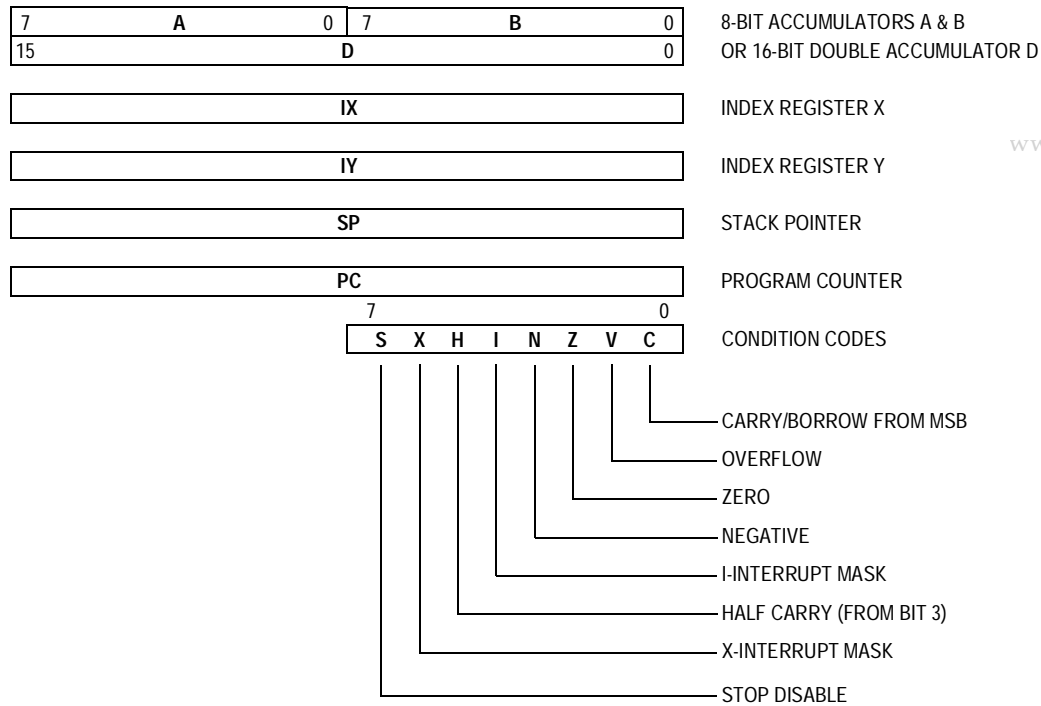

www.DataSheet4U.com

Figure 3-1. Programming Model

3.3.1 Accumulators A, B, and D

Accumulators A and B are general-purpose 8-bit registers that hold operands and results of arithmetic calculations or data manipulations. For some instructions, these two accumulators are treated as a single double-byte (16-bit) accumulator called accumulator D. Although most instructions can use accumulators A or B interchangeably, these exceptions apply:

- The ABX and ABY instructions add the contents of 8-bit accumulator B to the contents of 16-bit register X or Y, but there are no equivalent instructions that use A instead of B.
- The TAP and TPA instructions transfer data from accumulator A to the condition code register or from the condition code register to accumulator A. However, there are no equivalent instructions that use B rather than A.

- The decimal adjust accumulator A (DAA) instruction is used after binary-coded decimal (BCD) arithmetic operations, but there is no equivalent BCD instruction to adjust accumulator B.
- The add, subtract, and compare instructions associated with both A and B (ABA, SBA, and CBA) only operate in one direction, making it important to plan ahead to ensure that the correct operand is in the correct accumulator.

3.3.2 Index Register X (IX)

The IX register provides a 16-bit indexing value that can be added to the 8-bit offset provided in an instruction to create an effective address. The IX register can also be used as a counter or as a temporary storage register.

3.3.3 Index Register Y (IY)

The 16-bit IY register performs an indexed mode function similar to that of the IX register. However, most instructions using the IY register require an extra byte of machine code and an extra cycle of execution time because of the way the opcode map is implemented. Refer to [3.5 Opcodes and Operands](#) for further information.

3.3.4 Stack Pointer (SP)

The M68HC11 CPU has an automatic program stack. This stack can be located anywhere in the address space and can be any size up to the amount of memory available in the system. Normally, the SP is initialized by one of the first instructions in an application program. The stack is configured as a data structure that grows downward from high memory to low memory. Each time a new byte is pushed onto the stack, the SP is decremented. Each time a byte is pulled from the stack, the SP is incremented. At any given time, the SP holds the 16-bit address of the next free location in the stack. [Figure 3-2](#) is a summary of SP operations.

JSR, JUMP TO SUBROUTINE

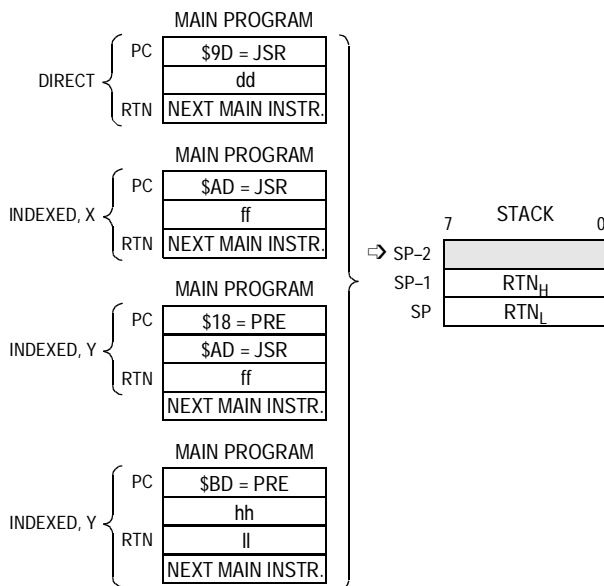

BSR, BRANCH TO SUBROUTINE

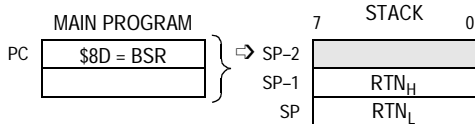

RTS, RETURN FROM SUBROUTINE

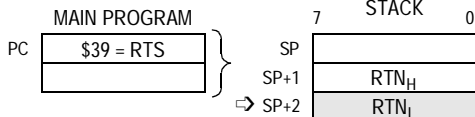

RTI, RETURN FROM INTERRUPT

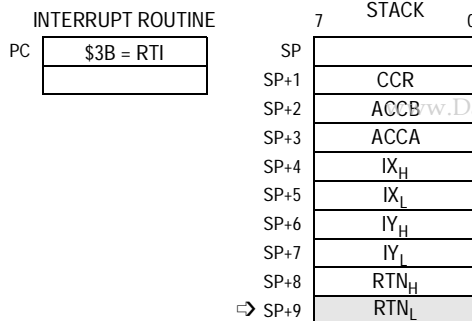

SWI, SOFTWARE INTERRUPT

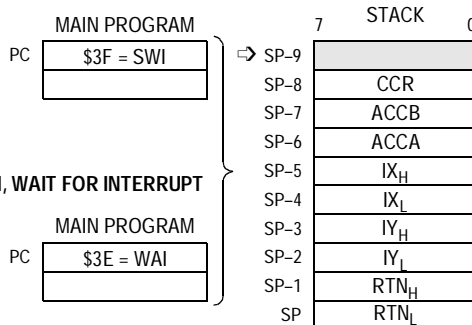

WAI, WAIT FOR INTERRUPT

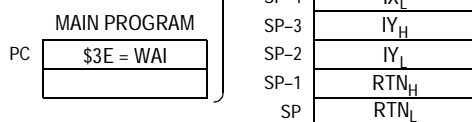

LEGEND:

- RTN = ADDRESS OF NEXT INSTRUCTION IN MAIN PROGRAM TO BE EXECUTED UPON RETURN FROM SUBROUTINE
- RTN_H = MOST SIGNIFICANT BYTE OF RETURN ADDRESS
- RTN_L = LEAST SIGNIFICANT BYTE OF RETURN ADDRESS
- \Rightarrow = STACK POINTER POSITION AFTER OPERATION IS COMPLETE
- dd = 8-BIT DIRECT ADDRESS ($\$0000-\$00FF$) (HIGH BYTE ASSUMED TO BE $\$00$)
- ff = 8-BIT POSITIVE OFFSET $\$00$ (0) TO $\$FF$ (255) IS ADDED TO INDEX
- hh = HIGH-ORDER BYTE OF 16-BIT EXTENDED ADDRESS
- ll = LOW-ORDER BYTE OF 16-BIT EXTENDED ADDRESS
- rr = SIGNED RELATIVE OFFSET $\$80$ (-128) TO $\$7F$ ($+127$) (OFFSET RELATIVE TO THE ADDRESS FOLLOWING THE MACHINE CODE OFFSET BYTE)

Figure 3-2. Stacking Operations

When a subroutine is called by a jump-to-subroutine (JSR) or branch-to-subroutine (BSR) instruction, the address of the instruction after the JSR or BSR is automatically pushed onto the stack, least significant byte first. When the subroutine is finished, a return-from-subroutine (RTS) instruction is executed. The RTS pulls the previously stacked return address from the stack and loads it into the program counter. Execution then continues at this recovered return address.

When an interrupt is recognized, the current instruction finishes normally, the return address (the current value in the program counter) is pushed onto the stack, all of the CPU registers are pushed onto the stack, and execution continues at the address specified by the vector for the interrupt.

At the end of the interrupt service routine, a return-from interrupt (RTI) instruction is executed. The RTI instruction causes the saved registers to be pulled off the stack in reverse order. Program execution resumes at the return address.

Certain instructions push and pull the A and B accumulators and the X and Y index registers and are often used to preserve program context. For example, pushing accumulator A onto the stack when entering a subroutine that uses accumulator A and then pulling accumulator A off the stack just before leaving the subroutine ensures that the contents of a register will be the same after returning from the subroutine as it was before starting the subroutine.

3.3.5 Program Counter (PC)

The program counter, a 16-bit register, contains the address of the next instruction to be executed. After reset, the program counter is initialized from one of six possible vectors, depending on operating mode and the cause of reset. See [Table 3-1](#).

Table 3-1. Reset Vector Comparison

Mode	POR or $\overline{\text{RESET}}$ Pin	Clock Monitor	COP Watchdog
Normal	\$FFFE, \$FFFF	\$FFFC, D	\$FFFA, B
Test or boot	\$BFFE, \$BFFF	\$BFFC, D	\$BFFA, B

3.3.6 Condition Code Register (CCR)

This 8-bit register contains:

- Five condition code indicators (C, V, Z, N, and H), www.DataSheet4U.com
- Two interrupt masking bits ($\overline{\text{IRQ}}$ and $\overline{\text{XIRQ}}$)
- A stop disable bit (S)

In the M68HC11 CPU, condition codes are updated automatically by most instructions. For example, load accumulator A (LDAA) and store accumulator A (STAA) instructions automatically set or clear the N, Z, and V condition code flags. Pushes, pulls, add B to X (ABX), add B to Y (ABY), and transfer/exchange instructions do not affect the condition codes. Refer to [Table 3-2](#), which shows what condition codes are affected by a particular instruction.

3.3.6.1 Carry/Borrow (C)

The C bit is set if the arithmetic logic unit (ALU) performs a carry or borrow during an arithmetic operation. The C bit also acts as an error flag for multiply and divide operations. Shift and rotate instructions operate with and through the carry bit to facilitate multiple-word shift operations.

3.3.6.2 Overflow (V)

The overflow bit is set if an operation causes an arithmetic overflow. Otherwise, the V bit is cleared.

3.3.6.3 Zero (Z)

The Z bit is set if the result of an arithmetic, logic, or data manipulation operation is 0. Otherwise, the Z bit is cleared. Compare instructions do an internal implied subtraction and the condition codes, including Z, reflect the results of that subtraction. A few operations (INX, DEX, INY, and DEY) affect the Z bit and no other condition flags. For these operations, only = and \neq conditions can be determined.

3.3.6.4 Negative (N)

The N bit is set if the result of an arithmetic, logic, or data manipulation operation is negative (MSB = 1). Otherwise, the N bit is cleared. A result is said to be negative if its most significant bit (MSB) is a 1. A quick way to test whether the contents of a memory location has the MSB set is to load it into an accumulator and then check the status of the N bit.

3.3.6.5 I-Interrupt Mask (I)

The interrupt request (IRQ) mask (I bit) is a global mask that disables all maskable interrupt sources. While the I bit is set, interrupts can become pending, but the operation of the CPU continues uninterrupted until the I bit is cleared. After any reset, the I bit is set by default and can be cleared only by a software instruction. When an interrupt is recognized, the I bit is set after the registers are stacked, but before the interrupt vector is fetched. After the interrupt has been serviced, a return-from-interrupt instruction is normally executed, restoring the registers to the values that were present before the interrupt occurred. Normally, the I bit is 0 after a return from interrupt is executed. Although the I bit can be cleared within an interrupt service routine, "nesting" interrupts in this way should be done only when there is a clear understanding of latency and of the arbitration mechanism. Refer to [Section 5. Resets and Interrupts](#).

3.3.6.6 Half Carry (H)

The H bit is set when a carry occurs between bits 3 and 4 of the arithmetic logic unit during an ADD, ABA, or ADC instruction. Otherwise, the H bit is cleared. Half carry is used during BCD operations.

3.3.6.7 X-Interrupt Mask (X)

The XIRQ mask (X) bit disables interrupts from the $\overline{\text{XIRQ}}$ pin. After any reset, X is set by default and must be cleared by a software instruction. When an $\overline{\text{XIRQ}}$ interrupt is recognized, the X and I bits are set after the registers are stacked, but before the interrupt vector is fetched. After the interrupt has been serviced, an RTI instruction is normally executed, causing the registers to be restored to the values that were present

before the interrupt occurred. The X interrupt mask bit is set only by hardware ($\overline{\text{RESET}}$ or $\overline{\text{XIRQ}}$ acknowledge). X is cleared only by program instruction (TAP, where the associated bit of A is 0; or RTI, where bit 6 of the value loaded into the CCR from the stack has been cleared).

There is no hardware action for clearing X.

3.3.6.8 STOP Disable (S)

Setting the STOP disable (S) bit prevents the STOP instruction from putting the M68HC11 into a low-power stop condition. If the STOP instruction is encountered by the CPU while the S bit is set, it is treated as a no-operation (NOP) instruction, and processing continues to the next instruction. S is set by reset; STOP is disabled by default.

3.4 Data Types

The M68HC11 CPU supports four data types:

1. Bit data
2. 8-bit and 16-bit signed and unsigned integers
3. 16-bit unsigned fractions
4. 16-bit addresses

A byte is eight bits wide and can be accessed at any byte location. A word is composed of two consecutive bytes with the most significant byte at the lower value address. Because the M68HC11 is an 8-bit CPU, there are no special requirements for alignment of instructions or operands.

3.5 Opcodes and Operands

The M68HC11 Family of microcontrollers uses 8-bit opcodes. Each opcode identifies a particular instruction and associated addressing mode to the CPU. Several opcodes are required to provide each instruction with a range of addressing capabilities. Only 256 opcodes

would be available if the range of values were restricted to the number able to be expressed in 8-bit binary numbers.

A 4-page opcode map has been implemented to expand the number of instructions. An additional byte, called a prebyte, directs the processor from page 0 of the opcode map to one of the other three pages. As its name implies, the additional byte precedes the opcode.

A complete instruction consists of a prebyte, if any, an opcode, and zero, one, two, or three operands. The operands contain information the CPU needs for executing the instruction. Complete instructions can be from one to five bytes long.

3.6 Addressing Modes

Six addressing modes can be used to access memory:

- Immediate
- Direct
- Extended
- Indexed
- Inherent
- Relative

These modes are detailed in the following paragraphs. All modes except inherent mode use an effective address. The effective address is the memory address from which the argument is fetched or stored or the address from which execution is to proceed. The effective address can be specified within an instruction, or it can be calculated.

3.6.1 Immediate

In the immediate addressing mode, an argument is contained in the byte(s) immediately following the opcode. The number of bytes following the opcode matches the size of the register or memory location being operated on. There are 2-, 3-, and 4- (if prebyte is required) byte

immediate instructions. The effective address is the address of the byte following the instruction.

www.DataSheet4U.com

3.6.2 Direct

In the direct addressing mode, the low-order byte of the operand address is contained in a single byte following the opcode, and the high-order byte of the address is assumed to be \$00. Addresses \$00–\$FF are thus accessed directly, using 2-byte instructions. Execution time is reduced by eliminating the additional memory access required for the high-order address byte. In most applications, this 256-byte area is reserved for frequently referenced data. In M68HC11 MCUs, the memory map can be configured for combinations of internal registers, RAM, or external memory to occupy these addresses.

3.6.3 Extended

In the extended addressing mode, the effective address of the argument is contained in two bytes following the opcode byte. These are 3-byte instructions (or 4-byte instructions if a prebyte is required). One or two bytes are needed for the opcode and two for the effective address.

3.6.4 Indexed

In the indexed addressing mode, an 8-bit unsigned offset contained in the instruction is added to the value contained in an index register (IX or IY). The sum is the effective address. This addressing mode allows referencing any memory location in the 64-Kbyte address space. These are 2- to 5-byte instructions, depending on whether a prebyte is required.

3.6.5 Inherent

In the inherent addressing mode, all the information necessary to execute the instruction is contained in the opcode. Operations that use only the index registers or accumulators, as well as control instructions with no arguments, are included in this addressing mode. These are 1- or 2-byte instructions.



3.6.6 Relative

The relative addressing mode is used only for branch instructions. If the branch condition is true, an 8-bit signed offset included in the instruction is added to the contents of the program counter to form the effective branch address. Otherwise, control proceeds to the next instruction. These are usually 2-byte instructions.

3.7 Instruction Set

Refer to **Table 3-2**, which shows all the M68HC11 instructions in all possible addressing modes. For each instruction, the table shows the operand construction, the number of machine code bytes, and execution time in CPU E-clock cycles.

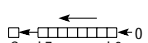
Table 3-2. Instruction Set (Sheet 1 of 7)

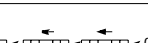
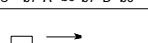
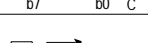
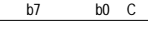
Mnemonic	Operation	Description	Addressing Mode	Instruction			Condition Codes																																																			
				Opcode	Operand	Cycles	S	X	H	I	N	Z	V	C																																												
ABA	Add Accumulators	$A + B \Rightarrow A$	INH	1B	—	2	—	—	Δ	—	Δ	Δ	Δ	Δ																																												
ABX	Add B to X	$IX + (00 : B) \Rightarrow IX$	INH	3A	—	3	—	—	—	—	—	—	—	—																																												
ABY	Add B to Y	$IY + (00 : B) \Rightarrow IY$	INH	18 3A	—	4	—	—	—	—	—	—	—	—																																												
ADCA (opr)	Add with Carry to A	$A + M + C \Rightarrow A$	A IMM A DIR A EXT A IND,X A IND,Y	18 89 99 B9 A9 A9	ii dd hh ll ff ff	2 3 4 4 5	—	—	Δ	—	Δ	Δ	Δ	Δ																																												
															ADCB (opr)	Add with Carry to B	$B + M + C \Rightarrow B$	B IMM B DIR B EXT B IND,X B IND,Y	18 C9 D9 F9 E9 E9	ii dd hh ll ff ff	2 3 4 4 5	—	—	Δ	—	Δ	Δ	Δ	Δ																													
																														ADDA (opr)	Add Memory to A	$A + M \Rightarrow A$	A IMM A DIR A EXT A IND,X A IND,Y	18 8B 9B BB AB AB	ii dd hh ll ff ff	2 3 4 4 5	—	—	Δ	—	Δ	Δ	Δ	Δ														
																																													ADDB (opr)	Add Memory to B	$B + M \Rightarrow B$	B IMM B DIR B EXT B IND,X B IND,Y	18 CB DB FB EB EB	ii dd hh ll ff ff	2 3 4 4 5	—	—	Δ	—	Δ	Δ	Δ
ANDA (opr)	AND A with Memory	$A \cdot M \Rightarrow A$	A IMM A DIR A EXT A IND,X A IND,Y	18 84 94 B4 A4 A4	ii dd hh ll ff ff	2 3 4 4 5	—	—	Δ	—	Δ	Δ	0	—																																												
															ANDB (opr)	AND B with Memory	$B \cdot M \Rightarrow B$	B IMM B DIR B EXT B IND,X B IND,Y	18 C4 D4 F4 E4 E4	ii dd hh ll ff ff	2 3 4 4 5	—	—	Δ	—	Δ	Δ	0	—																													
																														ASL (opr)	Arithmetic Shift Left		EXT IND,X IND,Y	18 78 68 68	hh ll ff ff	6 6 7	—	—	Δ	—	Δ	Δ	Δ	Δ														
																																													ASLA	Arithmetic Shift Left A		A INH	48	—	2	—	—	Δ	—	Δ	Δ	Δ
ASLB	Arithmetic Shift Left B		B INH	58	—	2	—	—	Δ	—	Δ	Δ	Δ																																													
														ASLD	Arithmetic Shift Left D		INH	05	—	3	—	—	Δ	—	Δ	Δ	Δ	Δ																														
ASR	Arithmetic Shift Right		EXT IND,X IND,Y	18 77 67 67	hh ll ff ff	6 6 7	—	—	Δ	—	Δ	Δ	Δ																Δ																													
														ASRA	Arithmetic Shift Right A		A INH	47	—	2	—	—	Δ	—	Δ	Δ	Δ																															
																												ASRB		Arithmetic Shift Right B		B INH	57	—	2	—	—	Δ	—	Δ	Δ	Δ																
BCC (rel)	Branch if Carry Clear	? C = 0	REL	24	rr	3	—	—	—	—	—	—	—																																													
BCLR (opr) (msk)	Clear Bit(s)	$M \cdot (mm) \Rightarrow M$	DIR IND,X IND,Y	15 1D 1D	dd mm ff mm ff mm	6 7 8	—	—	Δ	—	Δ	—	0	—	—																																											

Freescale Semiconductor, Inc.

Central Processor Unit (CPU)

Table 3-2. Instruction Set (Sheet 2 of 7)

Mnemonic	Operation	Description	Addressing Mode	Instruction			Condition Codes										
				Opcode	Operand	Cycles	S	X	H	I	N	Z	V	C			
BCS (rel)	Branch if Carry Set	? C = 1	REL	25	rr	3	—	—	—	—	—	—	—	—	—	—	
BEQ (rel)	Branch if = Zero	? Z = 1	REL	27	rr	3	—	—	—	—	—	—	—	—	—	—	
BGE (rel)	Branch if Δ Zero	? N \oplus V = 0	REL	2C	rr	3	—	—	—	—	—	—	—	—	—	—	
BGT (rel)	Branch if > Zero	? Z + (N \oplus V) = 0	REL	2E	rr	3	—	—	—	—	—	—	—	—	—	—	
BHI (rel)	Branch if Higher	? C + Z = 0	REL	22	rr	3	—	—	—	—	—	—	—	—	—	—	
BHS (rel)	Branch if Higher or Same	? C = 0	REL	24	rr	3	—	—	—	—	—	—	—	—	—	—	
BITA (opr)	Bit(s) Test A with Memory	A • M	A	IMM	85	ii	2	—	—	—	—	Δ	Δ	0	—	—	
			A	DIR	95	dd	3	—	—	—	—	—	—	—	—	—	—
			A	EXT	B5	hh ll	4	—	—	—	—	—	—	—	—	—	—
			A	IND,X	A5	ff	4	—	—	—	—	—	—	—	—	—	—
			A	IND,Y	18 A5	ff	5	—	—	—	—	—	—	—	—	—	—
BITB (opr)	Bit(s) Test B with Memory	B • M	B	IMM	C5	ii	2	—	—	—	—	Δ	Δ	0	—	—	
			B	DIR	D5	dd	3	—	—	—	—	—	—	—	—	—	—
			B	EXT	F5	hh ll	4	—	—	—	—	—	—	—	—	—	—
			B	IND,X	E5	ff	4	—	—	—	—	—	—	—	—	—	—
			B	IND,Y	18 E5	ff	5	—	—	—	—	—	—	—	—	—	—
BLE (rel)	Branch if Δ Zero	? Z + (N \oplus V) = 1	REL	2F	rr	3	—	—	—	—	—	—	—	—	—	—	
BLO (rel)	Branch if Lower	? C = 1	REL	25	rr	3	—	—	—	—	—	—	—	—	—	—	
BLS (rel)	Branch if Lower or Same	? C + Z = 1	REL	23	rr	3	—	—	—	—	—	—	—	—	—	—	
BLT (rel)	Branch if < Zero	? N \oplus V = 1	REL	2D	rr	3	—	—	—	—	—	—	—	—	—	—	
BMI (rel)	Branch if Minus	? N = 1	REL	2B	rr	3	—	—	—	—	—	—	—	—	—	—	
BNE (rel)	Branch if not = Zero	? Z = 0	REL	26	rr	3	—	—	—	—	—	—	—	—	—	—	
BPL (rel)	Branch if Plus	? N = 0	REL	2A	rr	3	—	—	—	—	—	—	—	—	—	—	
BRA (rel)	Branch Always	? 1 = 1	REL	20	rr	3	—	—	—	—	—	—	—	—	—	—	
BRCLR(opr) (msk) (rel)	Branch if Bit(s) Clear	? M • mm = 0		DIR	13	dd mm rr	6	—	—	—	—	—	—	—	—	—	
				IND,X	1F	ff mm rr	7	—	—	—	—	—	—	—	—	—	
			18	IND,Y	1F	ff mm rr	8	—	—	—	—	—	—	—	—	—	
BRN (rel)	Branch Never	? 1 = 0	REL	21	rr	3	—	—	—	—	—	—	—	—	—	—	
BRSET(opr) (msk) (rel)	Branch if Bit(s) Set	? (M) • mm = 0		DIR	12	dd mm rr	6	—	—	—	—	—	—	—	—	—	
				IND,X	1E	ff mm rr	7	—	—	—	—	—	—	—	—	—	
			18	IND,Y	1E	ff mm rr	8	—	—	—	—	—	—	—	—	—	
BSET (opr) (msk)	Set Bit(s)	M + mm \Rightarrow M		DIR	14	dd mm	6	—	—	—	—	Δ	Δ	0	—		
				IND,X	1C	ff mm	7	—	—	—	—	—	—	—	—		
				IND,Y	18 1C	ff mm	8	—	—	—	—	—	—	—	—		
BSR (rel)	Branch to Subroutine	See Figure 3-2	REL	8D	rr	6	—	—	—	—	—	—	—	—	—	—	
BVC (rel)	Branch if Overflow Clear	? V = 0	REL	28	rr	3	—	—	—	—	—	—	—	—	—	—	
BVS (rel)	Branch if Overflow Set	? V = 1	REL	29	rr	3	—	—	—	—	—	—	—	—	—	—	
CBA	Compare A to B	A – B	INH	11	—	2	—	—	—	—	Δ	Δ	Δ	Δ	—	—	
CLC	Clear Carry Bit	0 \Rightarrow C	INH	0C	—	2	—	—	—	—	—	—	—	—	0	—	
CLI	Clear Interrupt Mask	0 \Rightarrow I	INH	0E	—	2	—	—	—	0	—	—	—	—	—	—	
CLR (opr)	Clear Memory Byte	0 \Rightarrow M		EXT	7F	hh ll	6	—	—	—	—	0	1	0	0	—	
				IND,X	6F	ff	6	—	—	—	—	—	—	—	—	—	
			18	IND,Y	6F	ff	7	—	—	—	—	—	—	—	—	—	
CLRA	Clear Accumulator A	0 \Rightarrow A	A	INH	4F	—	2	—	—	—	—	0	1	0	0	—	
CLRB	Clear Accumulator B	0 \Rightarrow B	B	INH	5F	—	2	—	—	—	—	0	1	0	0	—	
CLV	Clear Overflow Flag	0 \Rightarrow V		INH	0A	—	2	—	—	—	—	—	—	0	—	—	
CMPA (opr)	Compare A to Memory	A – M	A	IMM	81	ii	2	—	—	—	—	Δ	Δ	Δ	Δ	—	
			A	DIR	91	dd	3	—	—	—	—	—	—	—	—	—	
			A	EXT	B1	hh ll	4	—	—	—	—	—	—	—	—	—	
			A	IND,X	A1	ff	4	—	—	—	—	—	—	—	—	—	
			A	IND,Y	18 A1	ff	5	—	—	—	—	—	—	—	—	—	

Table 3-2. Instruction Set (Sheet 3 of 7)

Mnemonic	Operation	Description	Addressing Mode	Instruction			Condition Codes							
				Opcode	Operand	Cycles	S	X	H	I	N	Z	V	C
CMPB (opr)	Compare B to Memory	B – M	B IMM	C1	ii	2	—	—	—	—	Δ	Δ	Δ	Δ
			B DIR	D1	dd	3								
			B EXT	F1	hh ll	4								
			B IND,X	E1	ff	4								
			B IND,Y	E1	ff	5								
COM (opr)	Ones Complement Memory Byte	\$FF – M ⇒ M	EXT	73	hh ll	6	—	—	—	—	Δ	Δ	0	1
			IND,X	63	ff	6								
			IND,Y	63	ff	7								
COMA	Ones Complement A	\$FF – A ⇒ A	A INH	43	—	2	—	—	—	—	Δ	Δ	0	1
COMB	Ones Complement B	\$FF – B ⇒ B	B INH	53	—	2	—	—	—	—	Δ	Δ	0	1
CPD (opr)	Compare D to Memory 16-Bit	D – M : M + 1	B IMM	1A 83	jj kk	5	—	—	—	—	Δ	Δ	Δ	Δ
			B DIR	1A 93	dd	6								
			B EXT	1A B3	hh ll	7								
			B IND,X	1A A3	ff	7								
			B IND,Y	CD A3	ff	7								
CPX (opr)	Compare X to Memory 16-Bit	IX – M : M + 1	B IMM	8C	jj kk	4	—	—	—	—	Δ	Δ	Δ	Δ
			B DIR	9C	dd	5								
			B EXT	BC	hh ll	6								
			B IND,X	AC	ff	6								
			B IND,Y	CD AC	ff	7								
CPY (opr)	Compare Y to Memory 16-Bit	IY – M : M + 1	B IMM	18 8C	jj kk	5	—	—	—	—	Δ	Δ	Δ	Δ
			B DIR	18 9C	dd	6								
			B EXT	18 BC	hh ll	7								
			B IND,X	1A AC	ff	7								
			B IND,Y	18 AC	ff	7								
DAA	Decimal Adjust A	Adjust Sum to BCD	INH	19	—	2	—	—	—	—	Δ	Δ	Δ	Δ
DEC (opr)	Decrement Memory Byte	M – 1 ⇒ M	EXT	7A	hh ll	6	—	—	—	—	Δ	Δ	Δ	—
			IND,X	6A	ff	6								
			IND,Y	6A	ff	7								
DECA	Decrement Accumulator A	A – 1 ⇒ A	A INH	4A	—	2	—	—	—	—	Δ	Δ	Δ	—
DECB	Decrement Accumulator B	B – 1 ⇒ B	B INH	5A	—	2	—	—	—	—	Δ	Δ	Δ	—
DES	Decrement Stack Pointer	SP – 1 ⇒ SP	INH	34	—	3	—	—	—	—	—	—	—	—
DEX	Decrement Index Register X	IX – 1 ⇒ IX	INH	09	—	3	—	—	—	—	—	Δ	—	—
DEY	Decrement Index Register Y	IY – 1 ⇒ IY	INH	18 09	—	4	—	—	—	—	—	Δ	—	—
EORA (opr)	Exclusive OR A with Memory	A ⊕ M ⇒ A	A IMM	88	ii	2	—	—	—	—	Δ	Δ	0	—
			A DIR	98	dd	3								
			A EXT	B8	hh ll	4								
			A IND,X	A8	ff	4								
			A IND,Y	18 A8	ff	5								
EORB (opr)	Exclusive OR B with Memory	B ⊕ M ⇒ B	B IMM	C8	ii	2	—	—	—	—	Δ	Δ	0	—
			B DIR	D8	dd	3								
			B EXT	F8	hh ll	4								
			B IND,X	E8	ff	4								
			B IND,Y	18 E8	ff	5								
FDIV	Fractional Divide 16 by 16	D / IX ⇒ IX; r ⇒ D	INH	03	—	41	—	—	—	—	—	Δ	Δ	Δ
IDIV	Integer Divide 16 by 16	D / IX ⇒ IX; r ⇒ D	INH	02	—	41	—	—	—	—	—	Δ	0	Δ
INC (opr)	Increment Memory Byte	M + 1 ⇒ M	EXT	7C	hh ll	6	—	—	—	—	Δ	Δ	Δ	—
			IND,X	6C	ff	6								
			IND,Y	6C	ff	7								
INCA	Increment Accumulator A	A + 1 ⇒ A	A INH	4C	—	2	—	—	—	—	Δ	Δ	Δ	—

Central Processor Unit (CPU)

Table 3-2. Instruction Set (Sheet 4 of 7)

Mnemonic	Operation	Description	Addressing Mode	Instruction			Condition Codes										
				Opcode	Operand	Cycles	S	X	H	I	N	Z	V	C			
INCB	Increment Accumulator B	$B + 1 \Rightarrow B$	B INH	5C	—	2	—	—	—	—	—	—	—	—	—	—	—
INS	Increment Stack Pointer	$SP + 1 \Rightarrow SP$	INH	31	—	3	—	—	—	—	—	—	—	—	—	—	—
INX	Increment Index Register X	$IX + 1 \Rightarrow IX$	INH	08	—	3	—	—	—	—	—	—	—	—	—	—	—
INY	Increment Index Register Y	$IY + 1 \Rightarrow IY$	INH	18 08	—	4	—	—	—	—	—	—	—	—	—	—	—
JMP (opr)	Jump	See Figure 3-2	EXT IND,X IND,Y	7E 6E 6E	hh ll ff ff	3 3 4	—	—	—	—	—	—	—	—	—	—	—
JSR (opr)	Jump to Subroutine	See Figure 3-2	DIR EXT IND,X IND,Y	9D BD AD AD	dd hh ll ff ff	5 6 6 7	—	—	—	—	—	—	—	—	—	—	—
LDA (opr)	Load Accumulator A	$M \Rightarrow A$	A IMM A DIR A EXT A IND,X A IND,Y	86 96 B6 A6 A6	ii dd hh ll ff ff	2 3 4 4 5	—	—	—	—	—	—	—	—	—	—	—
LDAB (opr)	Load Accumulator B	$M \Rightarrow B$	B IMM B DIR B EXT B IND,X B IND,Y	C6 D6 F6 E6 E6	ii dd hh ll ff ff	2 3 4 4 5	—	—	—	—	—	—	—	—	—	—	—
LDD (opr)	Load Double Accumulator D	$M \Rightarrow A, M + 1 \Rightarrow B$	IMM DIR EXT IND,X IND,Y	CC DC FC EC EC	jj kk dd hh ll ff ff	3 4 5 5 6	—	—	—	—	—	—	—	—	—	—	—
LDS (opr)	Load Stack Pointer	$M : M + 1 \Rightarrow SP$	IMM DIR EXT IND,X IND,Y	8E 9E BE AE AE	jj kk dd hh ll ff ff	3 4 5 5 6	—	—	—	—	—	—	—	—	—	—	—
LDX (opr)	Load Index Register X	$M : M + 1 \Rightarrow IX$	IMM DIR EXT IND,X IND,Y	CE DE FE EE EE	jj kk dd hh ll ff ff	3 4 5 5 6	—	—	—	—	—	—	—	—	—	—	—
LDY (opr)	Load Index Register Y	$M : M + 1 \Rightarrow IY$	IMM DIR EXT IND,X IND,Y	18 CE 18 DE 18 FE 1A EE 18 EE	jj kk dd hh ll ff ff	4 5 6 6 6	—	—	—	—	—	—	—	—	—	—	—
LSL (opr)	Logical Shift Left		EXT IND,X IND,Y	78 68 68	hh ll ff ff	6 6 7	—	—	—	—	—	—	—	—	—	—	—
LSLA	Logical Shift Left A		A INH	48	—	2	—	—	—	—	—	—	—	—	—	—	—
LSLB	Logical Shift Left B		B INH	58	—	2	—	—	—	—	—	—	—	—	—	—	—
LSLD	Logical Shift Left Double		INH	05	—	3	—	—	—	—	—	—	—	—	—	—	—
LSR (opr)	Logical Shift Right		EXT IND,X IND,Y	74 64 64	hh ll ff ff	6 6 7	—	—	—	—	—	—	—	—	—	—	—
LSRA	Logical Shift Right A		A INH	44	—	2	—	—	—	—	—	—	—	—	—	—	—

Table 3-2. Instruction Set (Sheet 5 of 7)

Mnemonic	Operation	Description	Addressing Mode	Instruction			Condition Codes								
				Opcode	Operand	Cycles	S	X	H	I	N	Z	V	C	
LSRB	Logical Shift Right B		B	INH	54	—	2	—	—	—	—	0	Δ	Δ	Δ
LSRD	Logical Shift Right Double			INH	04	—	3	—	—	—	—	0	Δ	Δ	Δ
MUL	Multiply 8 by 8	$A * B \Rightarrow D$		INH	3D	—	10	—	—	—	—	—	—	—	Δ
NEG (opr)	Two's Complement Memory Byte	$0 - M \Rightarrow M$		EXT IND,X IND,Y	70 60 60	hh ll ff ff	6 6 7	—	—	—	—	Δ	Δ	Δ	Δ
NEGA	Two's Complement A	$0 - A \Rightarrow A$	A	INH	40	—	2	—	—	—	—	Δ	Δ	Δ	Δ
NEGB	Two's Complement B	$0 - B \Rightarrow B$	B	INH	50	—	2	—	—	—	—	Δ	Δ	Δ	Δ
NOP	No operation	No Operation		INH	01	—	2	—	—	—	—	—	—	—	—
ORAA (opr)	OR Accumulator A (Inclusive)	$A + M \Rightarrow A$	A	IMM DIR EXT IND,X IND,Y	8A 9A BA AA AA	ii dd hh ll ff ff	2 3 4 4 5	—	—	—	—	Δ	Δ	0	—
ORAB (opr)	OR Accumulator B (Inclusive)	$B + M \Rightarrow B$	B	IMM DIR EXT IND,X IND,Y	CA DA FA EA EA	ii dd hh ll ff ff	2 3 4 4 5	—	—	—	—	Δ	Δ	0	—
PSHA	Push A onto Stack	$A \Rightarrow \text{Stk}, SP = SP - 1$	A	INH	36	—	3	—	—	—	—	—	—	—	—
PSHB	Push B onto Stack	$B \Rightarrow \text{Stk}, SP = SP - 1$	B	INH	37	—	3	—	—	—	—	—	—	—	—
PSHX	Push X onto Stack (Lo First)	$IX \Rightarrow \text{Stk}, SP = SP - 2$		INH	3C	—	4	—	—	—	—	—	—	—	—
PSHY	Push Y onto Stack (Lo First)	$IY \Rightarrow \text{Stk}, SP = SP - 2$		INH	18 3C	—	5	—	—	—	—	—	—	—	—
PULA	Pull A from Stack	$SP = SP + 1, A \Leftarrow \text{Stk}$	A	INH	32	—	4	—	—	—	—	—	—	—	—
PULB	Pull B from Stack	$SP = SP + 1, B \Leftarrow \text{Stk}$	B	INH	33	—	4	—	—	—	—	—	—	—	—
PULX	Pull X From Stack (Hi First)	$SP = SP + 2, IX \Leftarrow \text{Stk}$		INH	38	—	5	—	—	—	—	—	—	—	—
PULY	Pull Y from Stack (Hi First)	$SP = SP + 2, IY \Leftarrow \text{Stk}$		INH	18 38	—	6	—	—	—	—	—	—	—	—
ROL (opr)	Rotate Left			EXT IND,X IND,Y	79 69 69	hh ll ff ff	6 6 7	—	—	—	—	Δ	Δ	Δ	Δ
ROLA	Rotate Left A		A	INH	49	—	2	—	—	—	—	Δ	Δ	Δ	Δ
ROLB	Rotate Left B		B	INH	59	—	2	—	—	—	—	Δ	Δ	Δ	Δ
ROR (opr)	Rotate Right			EXT IND,X IND,Y	76 66 66	hh ll ff ff	6 6 7	—	—	—	—	Δ	Δ	Δ	Δ
RORA	Rotate Right A		A	INH	46	—	2	—	—	—	—	Δ	Δ	Δ	Δ
RORB	Rotate Right B		B	INH	56	—	2	—	—	—	—	Δ	Δ	Δ	Δ
RTI	Return from Interrupt	See Figure 3-2		INH	3B	—	12	Δ	↓	Δ	Δ	Δ	Δ	Δ	Δ

Central Processor Unit (CPU)

Table 3-2. Instruction Set (Sheet 6 of 7)

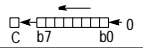
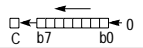
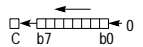
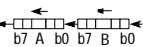
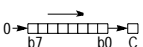
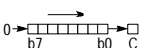
Mnemonic	Operation	Description	Addressing Mode	Instruction			Condition Codes									
				Opcode	Operand	Cycles	S	X	H	I	N	Z	V	C		
RTS	Return from Subroutine	See Figure 3-2	INH	39	—	5	—	—	—	—	—	—	—	—	—	
SBA	Subtract B from A	$A - B \Rightarrow A$	INH	10	—	2	—	—	—	—	Δ	Δ	Δ	Δ	—	
SBCA (opr)	Subtract with Carry from A	$A - M - C \Rightarrow A$	A	IMM	82	ii	2	—	—	—	—	Δ	Δ	Δ	Δ	—
				DIR	92	dd	3									
				EXT	B2	hh ll	4									
				IND,X	A2	ff	4									
				IND,Y	A2	ff	5									
SBCB (opr)	Subtract with Carry from B	$B - M - C \Rightarrow B$	B	IMM	C2	ii	2	—	—	—	—	Δ	Δ	Δ	Δ	—
				DIR	D2	dd	3									
				EXT	F2	hh ll	4									
				IND,X	E2	ff	4									
				IND,Y	E2	ff	5									
SEC	Set Carry	$1 \Rightarrow C$	INH	0D	—	2	—	—	—	—	—	—	—	—	1	
SEI	Set Interrupt Mask	$1 \Rightarrow I$	INH	0F	—	2	—	—	—	1	—	—	—	—	—	
SEV	Set Overflow Flag	$1 \Rightarrow V$	INH	0B	—	2	—	—	—	—	—	—	1	—	—	
STAA (opr)	Store Accumulator A	$A \Rightarrow M$	A	DIR	97	dd	3	—	—	—	—	Δ	Δ	0	—	
				EXT	B7	hh ll	4									
				IND,X	A7	ff	4									
				IND,Y	A7	ff	5									
STAB (opr)	Store Accumulator B	$B \Rightarrow M$	B	DIR	D7	dd	3	—	—	—	—	Δ	Δ	0	—	
				EXT	F7	hh ll	4									
				IND,X	E7	ff	4									
				IND,Y	E7	ff	5									
STD (opr)	Store Accumulator D	$A \Rightarrow M, B \Rightarrow M + 1$		DIR	DD	dd	4	—	—	—	—	Δ	Δ	0	—	
				EXT	FD	hh ll	5									
				IND,X	ED	ff	5									
				IND,Y	ED	ff	6									
STOP	Stop Internal Clocks	—	INH	CF	—	2	—	—	—	—	—	—	—	—	—	
STS (opr)	Store Stack Pointer	$SP \Rightarrow M : M + 1$		DIR	9F	dd	4	—	—	—	—	Δ	Δ	0	—	
				EXT	BF	hh ll	5									
				IND,X	AF	ff	5									
				IND,Y	AF	ff	6									
STX (opr)	Store Index Register X	$IX \Rightarrow M : M + 1$		DIR	DF	dd	4	—	—	—	—	Δ	Δ	0	—	
				EXT	FF	hh ll	5									
				IND,X	EF	ff	5									
				IND,Y	EF	ff	6									
STY (opr)	Store Index Register Y	$IY \Rightarrow M : M + 1$		DIR	18	DD	5	—	—	—	—	Δ	Δ	0	—	
				EXT	18	FF	hh ll									6
				IND,X	1A	EF	ff									6
				IND,Y	18	EF	ff									6
SUBA (opr)	Subtract Memory from A	$A - M \Rightarrow A$	A	IMM	80	ii	2	—	—	—	—	Δ	Δ	Δ	Δ	—
				DIR	90	dd	3									
				EXT	B0	hh ll	4									
				IND,X	A0	ff	4									
				IND,Y	A0	ff	5									
SUBB (opr)	Subtract Memory from B	$B - M \Rightarrow B$	A	IMM	C0	ii	2	—	—	—	—	Δ	Δ	Δ	Δ	—
				DIR	D0	dd	3									
				EXT	F0	hh ll	4									
				IND,X	E0	ff	4									
				IND,Y	E0	ff	5									
SUBD (opr)	Subtract Memory from D	$D - M : M + 1 \Rightarrow D$		IMM	83	jj kk	4	—	—	—	—	Δ	Δ	Δ	Δ	—
				DIR	93	dd	5									
				EXT	B3	hh ll	6									
				IND,X	A3	ff	6									
				IND,Y	A3	ff	7									
SWI	Software Interrupt	See Figure 3-2	INH	3F	—	14	—	—	—	1	—	—	—	—	—	
TAB	Transfer A to B	$A \Rightarrow B$	INH	16	—	2	—	—	—	—	Δ	Δ	0	—	—	
TAP	Transfer A to CC Register	$A \Rightarrow CCR$	INH	06	—	2	Δ	↓	Δ	Δ	Δ	Δ	Δ	Δ	Δ	
TBA	Transfer B to A	$B \Rightarrow A$	INH	17	—	2	—	—	—	—	Δ	Δ	0	—	—	

Table 3-2. Instruction Set (Sheet 7 of 7)

Mnemonic	Operation	Description	Addressing Mode	Instruction			Condition Codes								
				Opcode	Operand	Cycles	S	X	H	I	N	Z	V	C	
TEST	TEST (Only in Test Modes)	Address Bus Counts	INH	00	—	*	—	—	—	—	—	—	—	—	—
TPA	Transfer CC Register to A	CCR ⇒ A	INH	07	—	2	—	—	—	—	—	—	—	—	—
TST (opr)	Test for Zero or Minus	M – 0	EXT IND,X IND,Y	7D 6D 6D	hh ll ff ff	6 6 7	—	—	—	—	Δ	Δ	0	0	
TSTA	Test A for Zero or Minus	A – 0	A INH	4D	—	2	—	—	—	—	Δ	Δ	0	0	
TSTB	Test B for Zero or Minus	B – 0	B INH	5D	—	2	—	—	—	—	Δ	Δ	0	0	
TSX	Transfer Stack Pointer to X	SP + 1 ⇒ IX	INH	30	—	3	—	—	—	—	—	—	—	—	
TSY	Transfer Stack Pointer to Y	SP + 1 ⇒ IY	INH	18 30	—	4	—	—	—	—	—	—	—	—	
TXS	Transfer X to Stack Pointer	IX – 1 ⇒ SP	INH	35	—	3	—	—	—	—	—	—	—	—	
TYS	Transfer Y to Stack Pointer	IY – 1 ⇒ SP	INH	18 35	—	4	—	—	—	—	—	—	—	—	
WAI	Wait for Interrupt	Stack Regs & WAIT	INH	3E	—	**	—	—	—	—	—	—	—	—	
XGDY	Exchange D with X	IX ⇒ D, D ⇒ IX	INH	8F	—	3	—	—	—	—	—	—	—	—	
XGDY	Exchange D with Y	IY ⇒ D, D ⇒ IY	INH	18 8F	—	4	—	—	—	—	—	—	—	—	

Cycle

* Infinity or until reset occurs

** 12 cycles are used beginning with the opcode fetch. A wait state is entered which remains in effect for an integer number of MPU E-clock cycles (n) until an interrupt is recognized. Finally, two additional cycles are used to fetch the appropriate interrupt vector (14 + n total).

Operands

- dd = 8-bit direct address (\$0000–\$00FF) (high byte assumed to be \$00)
- ff = 8-bit positive offset \$00 (0) to \$FF (255) (is added to index)
- hh = High-order byte of 16-bit extended address
- ii = One byte of immediate data
- jj = High-order byte of 16-bit immediate data
- kk = Low-order byte of 16-bit immediate data
- ll = Low-order byte of 16-bit extended address
- mm = 8-bit mask (set bits to be affected)
- rr = Signed relative offset \$80 (–128) to \$7F (+127)
(offset relative to address following machine code offset byte)

Operators

- () Contents of register shown inside parentheses
- ← Is transferred to
- ↑ Is pulled from stack
- ↓ Is pushed onto stack
- Boolean AND
- + Arithmetic addition symbol except where used as inclusive-OR symbol in Boolean formula
- ⊕ Exclusive-OR
- * Multiply
- :
- Arithmetic subtraction symbol or negation symbol (two's complement)

Condition Codes

- Bit not changed
- 0 Bit always cleared
- 1 Bit always set
- Δ Bit cleared or set, depending on operation
- ↓ Bit can be cleared, cannot become set

Section 4. Operating Modes and On-Chip Memory

www.DataSheet4U.com

4.1 Contents

4.2	Introduction	43
4.3	Operating Modes	44
4.3.1	Bootstrap Mode	44
4.3.2	Special Test Mode	44
4.3.3	Expanded Operating Mode	45
4.4	Mode Selection	46
4.5	On-Chip Memory	48
4.5.1	Memory Map and Register Block	49
4.5.2	RAM	56

4.2 Introduction

The MC68HC11ED0 microcontroller (MCU) has three modes of operation. For expanded and special test modes, there are no reset or interrupt vectors contained in on-chip resources. An external memory must be used to provide vectors at locations \$FFC0–\$FFFF. In bootstrap mode, a small on-chip read-only memory (ROM) becomes present in the memory map and provides the vectors for this mode. Refer to [Figure 4-3](#).

4.3 Operating Modes

This subsection describes the three memory modes:

- Bootstrap mode
- Special test mode
- Expanded operating mode

www.DataSheet4U.com

Refer to [Figure 4-3](#).

4.3.1 Bootstrap Mode

Bootstrap mode allows special-purpose programs to be entered into internal random-access memory (RAM). The MCU contains 256 bytes of bootstrap ROM which is enabled and present in the memory map only when the device is in bootstrap mode. The bootstrap ROM contains a small program which initializes the serial communications interface (SCI) and allows the user to download exactly 256 bytes of code into on-chip RAM. After receiving the character for address \$01FF, control passes to the loaded program at \$0100. Vectors are present on chip and located at \$BFC0–\$BFFF.

4.3.2 Special Test Mode

Special test mode is used primarily for factory testing. In this operating mode, vectors must be provided externally at \$BFC0–\$BFFF.

4.3.3 Expanded Operating Mode

In expanded operating mode, the MCU has a 64-Kbyte address range and, using the expansion bus, can access external resources within the 64-Kbyte space. This space includes: www.DataSheet4U.com

- On-chip memory addresses
- Addressing capabilities for external peripheral and memory devices

In expanded operating mode, high-order address bits are output on ADDR[15:8] pins, low-order address bits and the data bus are multiplexed on ADDR/DATA[7:0]. Refer to [Figure 1-1. MC68HC11ED0 Block Diagram](#).

The read/write (R/\overline{W}) and address strobe (AS) signals allow the low-order address and the 8-bit data bus to be time-multiplexed on the same pins.

- During the first half of each bus cycle, address information is present.
- During the second half of each bus cycle, the pins become the bidirectional data bus.

AS is an active-high latch enable signal for an external address latch. Address information is allowed through the transparent latch while AS is high and is latched when AS drives low. The address, R/\overline{W} , and AS signals are active and valid for all bus cycles including accesses to internal memory locations.

The E clock is used to enable external devices to drive data onto the internal data bus during the second half of a read bus cycle (E clock high). R/\overline{W} controls the direction of data transfers. R/\overline{W} drives low when data is being written to the external data bus. R/\overline{W} will remain low during consecutive data bus write cycles, such as when a double-byte store occurs. Refer to [Figure 4-1](#) for an example of address and data multiplexing.

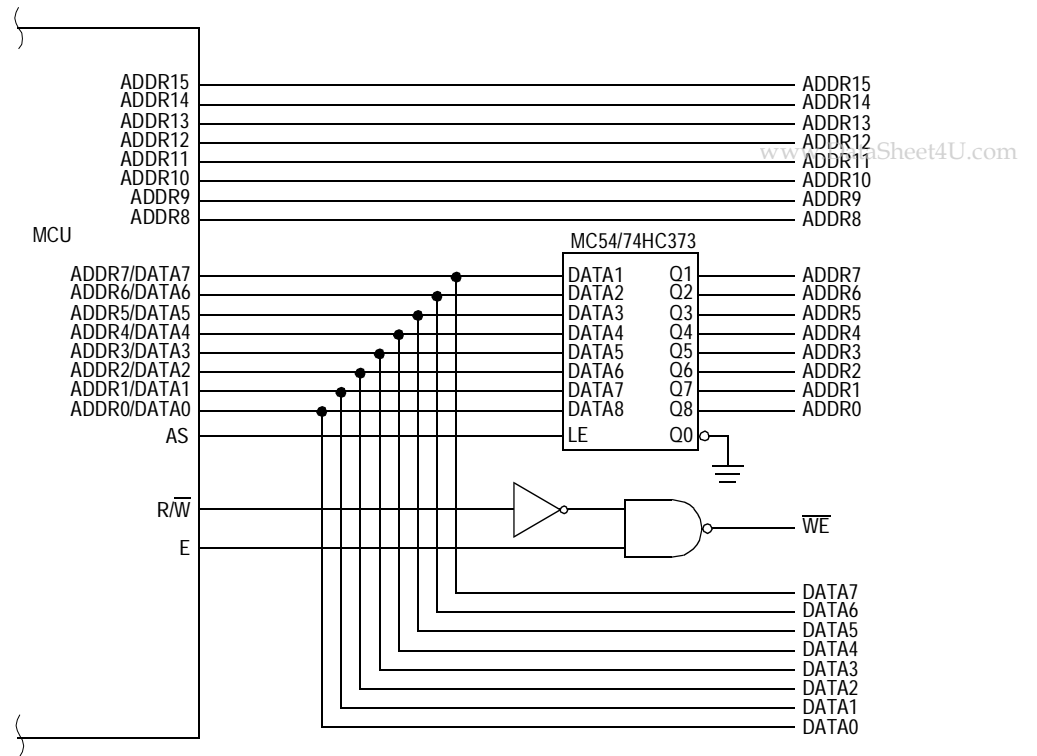

Figure 4-1. Address and Data Demultiplexing

4.4 Mode Selection

Operating modes are selected by a combination of logic levels applied to two input pins (MODA and MODB) during reset. The logic level present (at the rising edge of reset) on these inputs is reflected in bits in the highest priority I-bit interrupt and miscellaneous (HPRIO) register. After reset, the operating mode may be changed as shown in [Figure 4-2](#).

Address: \$003C

	Bit 7	6	5	4	3	2	1	Bit 0
Read:	RBOOT ⁽¹⁾	SMOD ⁽¹⁾	MDA ⁽¹⁾	IRVNE ⁽¹⁾	PSEL3	PSEL2	PSEL1	PSEL0
Write:								
Resets:								
Expanded:	0	0	1	0	0	1	0	1
Bootstrap:	1	1	0	0	0	1	0	1
Special Test:	0	1	1	1	0	1	0	1

1. The reset values depend on the mode selected at power-up.

Figure 4-2. Highest Priority I-Bit Interrupt and Miscellaneous Register (HPRIO)

RBOOT — Read Bootstrap ROM Bit

Valid only when SMOD is set (bootstrap or special test mode); can be written only in special modes

0 = Bootloader ROM disabled and not in map

1 = Bootloader ROM enabled and in map at \$BE00–\$BFFF

SMOD and MDA — Special Mode Select and Mode Select A Bits

The initial value of SMOD is the inverse of the logic level present on the MODB pin at the rising edge of reset. The initial value of MDA equals the logic level present on the MODA pin at the rising edge of reset. These two bits can be read at any time. They can be written any time in special modes. MDA can be written only once in normal modes. SMOD cannot be set once it has been cleared.

Input		Mode	Latched at Reset	
MODB	MODA		SMOD	MDA
1	0	High-impedance state ADDR/DATA (CPU held in reset)	0	0
1	1	Expanded	0	1
0	0	Bootstrap	1	0
0	1	Special test	1	1

CAUTION: *Unlike other M68HC11 Family devices, the MC68HC11ED0 will not function in single-chip operating mode. If MODA is pulled low and MODB is pulled high at the rising edge of reset (the condition that causes most*

M68HC11 devices to enter single-chip mode) the CPU will remain in reset until the \overline{RESET} pin is pulled low then released with appropriate logic levels applied to MODA and MODB.

www.DataSheet4U.com

IRVNE — Internal Read Visibility/Not E Bit

IRVNE can be written once in any mode. In special test mode, IRVNE is reset to 1. In all other modes, IRVNE is reset to 0.

In expanded test modes, IRVNE determines whether internal read visibility (IRV) is on or off.

0 = No internal read visibility on external bus

1 = Data from internal reads driven out the external data bus

In bootstrap mode, IRVNE determines whether the E clock drives out from the chip.

0 = E driven out from the chip

1 = E pin driven low

Mode	IRVNE Out of Reset	E Clock Out of Reset	IRV Out of Reset	IRVNE Affects Only	IRVNE Can Be Written
Expanded	0	On	Off	IRV	Once
Bootstrap	0	On	Off	E	Once
Special test	1	On	On	IRV	Once

PSEL[3:0] — Priority Select Bits

Refer to [Section 5. Resets and Interrupts](#).

4.5 On-Chip Memory

The MC68HC11ED0 contains 512 bytes of on-chip static RAM. There is no on-chip ROM. Since the MC68HC11ED0 is intended for expanded mode applications only, reset and interrupt vectors are not contained in on-chip resources. An external memory must provide these at locations \$FFC0–\$FFFF. Refer to [Figure 4-3](#).

4.5.1 Memory Map and Register Block

The INIT register controls the location of the register block and RAM in the 64-Kbyte central processor unit (CPU) address space. The 64-Kbyte register block originates at \$0000 after reset and can be placed at any 4-Kbyte boundary (\$x000) by writing an appropriate value to the INIT register. Since the RAM also begins at \$0000 after reset, 64 bytes are overlaid by the register block. Registers are a higher priority resource than RAM. Therefore, the RAM which is overlaid by registers is inaccessible. Either the registers or the RAM must be remapped to gain access to all 512 bytes of the RAM. Refer to **Figure 4-3** and **Figure 4-4**.

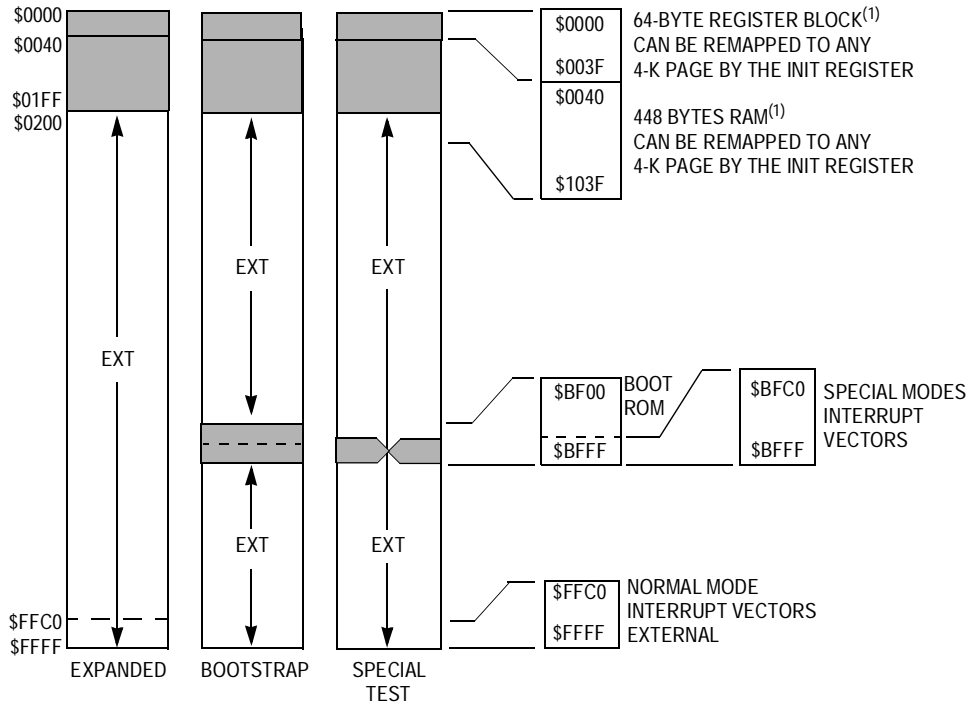

Note 1. To access the full 512 bytes of RAM, remap either the register block or the RAM to any 4-K (\$x000) boundary.

Figure 4-3. MC68HC11ED0 Memory Map

Operating Modes and On-Chip Memory

Addr.	Register Name	Bit 7	6	5	4	3	2	1	Bit 0	
\$0000	Port A Data Register (PORTA) <i>See page 66.</i>	Read:	PA7	PA6	PA5	PA4	PA3	PA2	PA1	PA0
		Write:								
		Reset:	U	0	0	0	U	U	U	U
\$0001	Reserved	R	R	R	R	R	R	R	R	
↓										
\$0007	Reserved	R	R	R	R	R	R	R	R	
\$0008	Port D Data Register (PORTD) <i>See page 68.</i>	Read:			PD5	PD4	PD3	PD2	PD1	PD0
		Write:								
		Reset:	0	0	U	U	U	U	U	U
\$0009	Port D Data Direction Register (DDRD) <i>See page 69.</i>	Read:			DDD5	DDD4	DDD3	DDD2	DDD1	DDD0
		Write:								
		Reset:	0	0	0	0	0	0	0	0
\$000A	Reserved	R	R	R	R	R	R	R	R	
\$000B	Timer Compare Force Register (CFORC) <i>See page 91.</i>	Read:	FOC1	FOC2	FOC3	FOC4	FOC5			
		Write:								
		Reset:	0	0	0	0	0	0	0	0
\$000C	Output Compare 1 Mask Register (OC1M) <i>See page 92.</i>	Read:	OC1M7	OC1M6	OC1M5	OC1M4	OC1M3			
		Write:								
		Reset:	0	0	0	0	0	0	0	0
\$000D	Output Compare 1 Data Register (OC1D) <i>See page 92.</i>	Read:	OC1D7	OC1D6	OC1D5	OC1D4	OC1D3			
		Write:								
		Reset:	0	0	0	0	0	0	0	0
\$000E	Timer Count Register High (TCNT) <i>See page 93.</i>	Read:	Bit 15	Bit 14	Bit 13	Bit 12	Bit 11	Bit 10	Bit 9	Bit 8
		Write:								
		Reset:	0	0	0	0	0	0	0	0

= Unimplemented
 R = Reserved
 U = Unaffected

Figure 4-4. Register and Control Bit Assignments (Sheet 1 of 6)

Addr.	Register Name	Bit 7	6	5	4	3	2	1	Bit 0	
\$000F	Timer Count Register Low (TCNT) See page 93.	Read:	Bit 7	Bit 6	Bit 5	Bit 4	Bit 3	Bit 2	Bit 1	Bit 0
		Write:								
		Reset:	0	0	0	0	0	0	0	0
\$0010	Timer Input Capture Register 1 High (TIC1) See page 94.	Read:	Bit 15	Bit 14	Bit 13	Bit 12	Bit 11	Bit 10	Bit 9	Bit 8
		Write:								
		Reset:	Unaffected by reset							
\$0011	Timer Input Capture Register 1 Low (TIC1) See page 94.	Read:	Bit 7	Bit 6	Bit 5	Bit 4	Bit 3	Bit 2	Bit 1	Bit 0
		Write:								
		Reset:	Unaffected by reset							
\$0012	Timer Input Capture Register 2 High (TIC2) See page 94.	Read:	Bit 15	Bit 14	Bit 13	Bit 12	Bit 11	Bit 10	Bit 9	Bit 8
		Write:								
		Reset:	Unaffected by reset							
\$0013	Timer Input Capture Register 2 Low (TIC2) See page 94.	Read:	Bit 7	Bit 6	Bit 5	Bit 4	Bit 3	Bit 2	Bit 1	Bit 0
		Write:								
		Reset:	Unaffected by reset							
\$0014	Timer Input Capture Register 3 High (TIC3) See page 94.	Read:	Bit 15	Bit 14	Bit 13	Bit 12	Bit 11	Bit 10	Bit 9	Bit 8
		Write:								
		Reset:	Unaffected by reset							
\$0015	Timer Input Capture Register 3 Low (TIC3) See page 94.	Read:	Bit 7	Bit 6	Bit 5	Bit 4	Bit 3	Bit 2	Bit 1	Bit 0
		Write:								
		Reset:	Unaffected by reset							
\$0016	Timer Output Compare Register 1 High (TOC1) See page 95.	Read:	Bit 15	Bit 14	Bit 13	Bit 12	Bit 11	Bit 10	Bit 9	Bit 8
		Write:								
		Reset:	1	1	1	1	1	1	1	1
\$0017	Timer Output Compare Register 1 Low (TOC1) See page 95.	Read:	Bit 7	Bit 6	Bit 5	Bit 4	Bit 3	Bit 2	Bit 1	Bit 0
		Write:								
		Reset:	1	1	1	1	1	1	1	1

= Unimplemented
 R = Reserved
 U = Unaffected

Figure 4-4. Register and Control Bit Assignments (Sheet 2 of 6)

Operating Modes and On-Chip Memory

Freescale Semiconductor, Inc.

Addr.	Register Name		Bit 7	6	5	4	3	2	1	Bit 0
\$0018	Timer Output Compare Register 2 High (TOC2) See page 95.	Read:	Bit 15	Bit 14	Bit 13	Bit 12	Bit 11	Bit 10	Bit 9	Bit 8
		Write:								
		Reset:	1	1	1	1	1	1	1	1
\$0019	Timer Output Compare Register 2 Low (TOC2) See page 95.	Read:	Bit 7	Bit 6	Bit 5	Bit 4	Bit 3	Bit 2	Bit 1	Bit 0
		Write:								
		Reset:	1	1	1	1	1	1	1	1
\$001A	Timer Output Compare Register 3 High (TOC3) See page 95.	Read:	Bit 15	Bit 14	Bit 13	Bit 12	Bit 11	Bit 10	Bit 9	Bit 8
		Write:								
		Reset:	1	1	1	1	1	1	1	1
\$001B	Timer Output Compare Register 3 Low (TOC3) See page 95.	Read:	Bit 7	Bit 6	Bit 5	Bit 4	Bit 3	Bit 2	Bit 1	Bit 0
		Write:								
		Reset:	1	1	1	1	1	1	1	1
\$001C	Timer Output Compare Register 4 High (TOC4) See page 96.	Read:	Bit 15	Bit 14	Bit 13	Bit 12	Bit 11	Bit 10	Bit 9	Bit 8
		Write:								
		Reset:	1	1	1	1	1	1	1	1
\$001D	Timer Output Compare Register 4 Low (TOC4) See page 96.	Read:	Bit 7	Bit 6	Bit 5	Bit 4	Bit 3	Bit 2	Bit 1	Bit 0
		Write:								
		Reset:	1	1	1	1	1	1	1	1
\$001E	Timer Input Capture4/Output Compare 5 High (TI4/O5) See page 96.	Read:	Bit 15	Bit 14	Bit 13	Bit 12	Bit 11	Bit 10	Bit 9	Bit 8
		Write:								
		Reset:	1	1	1	1	1	1	1	1
\$001F	Timer Input Capture4/Output Compare 5 Low (TI4/O5) See page 96.	Read:	Bit 7	Bit 6	Bit 5	Bit 4	Bit 3	Bit 2	Bit 1	Bit 0
		Write:								
		Reset:	1	1	1	1	1	1	1	1
\$0020	Timer Control Register 1 (TCTL1) See page 97.	Read:	OM2	OL2	OM3	OL3	OM4	OL4	OM5	OL5
		Write:								
		Reset:	0	0	0	0	0	0	0	0

= Unimplemented
 = Reserved
 U = Unaffected

Figure 4-4. Register and Control Bit Assignments (Sheet 3 of 6)

Addr.	Register Name	Bit 7	6	5	4	3	2	1	Bit 0	
\$0021	Timer Control Register 2 (TCTL2) See page 98.	Read:	EDG4B	EDG4A	EDG1B	EDG1A	EDG2B	EDG2A	EDG3B	EDG3A
		Write:								
		Reset:	0	0	0	0	0	0	0	0
\$0022	Timer Interrupt Mask 1 Register (TMSK1) See page 99.	Read:	OC1I	OC2I	OC3I	OC4I	I4/O5I	IC1I	IC2I	IC3I
		Write:								
		Reset:	0	0	0	0	0	0	0	0
\$0023	Timer Interrupt Flag 1 Register (TFLG1) See page 100.	Read:	OC1F	OC2F	OC3F	OC4F	I4/O5F	IC1F	IC2F	IC3F
		Write:								
		Reset:	0	0	0	0	0	0	0	0
\$0024	Timer Interrupt Mask 2 Register (TMSK2) See page 100.	Read:	TOI	RTII	PAOVI	PAII			PR1	PR0
		Write:								
		Reset:	0	0	0	0	0	0	0	0
\$0025	Timer Interrupt Flag 2 Register (TFLG2) See page 102.	Read:	TOF	RTIF	PAOVF	PAIF				
		Write:								
		Reset:	0	0	0	0	0	0	0	0
\$0026	Pulse Accumulator Control Register (PACTL) See page 104.	Read:	DDRA7	PAEN	PAMOD	PEDGE	DDRA3	I4/O5	RTR1	RTR0
		Write:								
		Reset:	0	0	0	0	0	0	0	0
\$0027	Pulse Accumulator Counter Register (PACNT) See page 106.	Read:	Bit 7	Bit 6	Bit 5	Bit 4	Bit 3	Bit 2	Bit 1	Bit 0
		Write:								
		Reset:	Unaffected by reset							
\$0028	Serial Peripheral Control Register (SPCR) See page 83.	Read:	SPIE	SPE	DWOM	MSTR	CPOL	CPHA	SPR1	SPR0
		Write:								
		Reset:	0	0	0	0	0	1	0	0
\$0029	Serial Peripheral Status Register (SPSR) See page 85.	Read:	SPIF	WCOL		MODF				
		Write:								
		Reset:	0	0	0	0	0	0	0	0

= Unimplemented
 = Reserved
 U = Unaffected

Figure 4-4. Register and Control Bit Assignments (Sheet 4 of 6)

Operating Modes and On-Chip Memory

Freescale Semiconductor, Inc.

Addr.	Register Name	Bit 7	6	5	4	3	2	1	Bit 0	
\$002A	SPI Data Register I/O (SPDR) See page 86.	Read:	Bit 7	Bit 6	Bit 5	Bit 4	Bit 3	Bit 2	Bit 1	Bit 0
		Write:								
		Reset:	Indeterminate after reset							
\$002B	Baud Rate Register (BAUD) See page 74.	Read:	TCLR		SCP1	SCP0	RCKB	SCR2	SCR1	SCR0
		Write:								
		Reset:	0	0	0	0	0	U	U	U
\$002C	SCI Control Register 1 (SCCR1) See page 77.	Read:	R8	T8		M	WAKE			
		Write:								
		Reset:	0	0	0	0	0	0	0	0
\$002D	SCI Control Register 2 (SCCR2) See page 78.	Read:	TIE	TCIE	RIE	ILIE	TE	RE	RWU	SBK
		Write:								
		Reset:	0	0	0	0	0	0	0	0
\$002E	SCI Status Register (SCSR) See page 79.	Read:	TDRE	TC	RDRF	IDLE	OR	NF	FE	
		Write:								
		Reset:	1	1	0	0	0	0	0	0
\$002F	SCI Data Register (SCDR) See page 80.	Read:	R7/T7	R6/T6	R5/T5	R4/T4	R3/T3	R2/T2	R1/T1	R0/T0
		Write:								
		Reset:	Unaffected by reset							
\$0030	Reserved	R	R	R	R	R	R	R	R	
↓										
\$0038	Reserved	R	R	R	R	R	R	R	R	
\$0039	System Configuration Options Register (OPTION) See page 60.	Read:			IRQE ⁽¹⁾	DLY ⁽¹⁾	CME		CR1 ⁽¹⁾	CR0 ⁽¹⁾
		Write:								
		Reset:	0	0	0	1	0	0	0	0

Note 1. Can be written only once in the first 64 cycles out of reset in normal modes or at any time in special modes.

 = Unimplemented  = Reserved U = Unaffected

Figure 4-4. Register and Control Bit Assignments (Sheet 5 of 6)

Addr.	Register Name	Bit 7	6	5	4	3	2	1	Bit 0	
\$003A	Arm/Reset COP Timer Circuitry Register (COPRST) See page 61.	Read:	Bit 7	Bit 6	Bit 5	Bit 4	Bit 3	Bit 2	Bit 1	Bit 0
		Write:								
		Reset:	0	0	0	0	0	0	0	0
\$003B	Reserved	R	R	R	R	R	R	R	R	
\$003C	Highest Priority I-Bit Interrupt and Miscellaneous Register (HPRIO) See page 63.	Read:	RBOOT	SMOD	MDA	IRVNE ⁽¹⁾	PSEL3	PSEL2	PSEL1	PSEL0
		Write:								
		Reset:	Note 1	Note 1	Note 1	U	0	1	0	1
Note 1. RBOOT, SMOD, and MDA reset depends on power-up initialization mode and can be written only in special mode.										
\$003D	RAM and Register Mapping Register (INIT) See page 56.	Read:	RAM3	RAM2	RAM1	RAM0	REG3	REG2	REG1	REG0
		Write:								
		Reset:	0	0	0	0	0	0	0	0
\$003E	Reserved	R	R	R	R	R	R	R	R	
\$003F	System Configuration Register (CONFIG) See page 62.	Read:						NOCOP		
		Write:								
		Reset:	0	0	0	0	0	0	0	0
				= Unimplemented		= Reserved	U = Unaffected			

Figure 4-4. Register and Control Bit Assignments (Sheet 6 of 6)

4.5.2 RAM

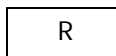
The MC68HC11ED0 has 512 bytes of on-chip static RAM. The RAM can be mapped to any 4-Kbyte boundary. Upon reset, the RAM is mapped at \$0000–\$01FF. The register block also begins at \$0000 and overlaps the RAM space. Since registers have priority over RAM, this causes 64 bytes of RAM to be lost. However, the user can map either the RAM or the register block to any 4-Kbyte boundary (\$x000) and access the full 512 bytes of RAM. Remapping is accomplished by writing appropriate values to the INIT register.

When power is removed from the MCU, RAM contents may be preserved using the MODB/V_{STBY} pin. A 4-volt nominal power source applied to this pin protects all 512 bytes of RAM.

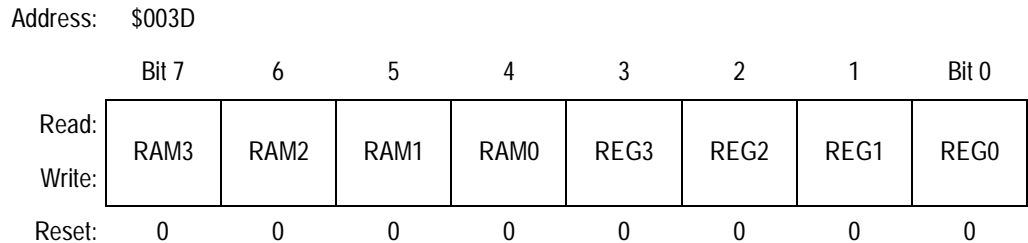

Figure 4-5. RAM and Register Mapping Register (INIT)

NOTE: *INIT can be written only once in the first 64-cycles out of reset in normal modes or at any time in special modes.*

RAM[3:0] — Internal RAM Map Position Bits

These bits determine the upper four bits of the RAM address. At reset RAM is mapped to \$0000 and includes the register block. Refer to [Figure 4-3](#).

REG[3:0] — 128-Byte Register Block Map Position Bits

These bits determine the upper four bits of the register space address. At reset registers are mapped to \$0000 and overwrite the first 64 bytes of RAM. Refer to [Figure 4-3](#).

Section 5. Resets and Interrupts

www.DataSheet4U.com

5.1 Contents

5.2	Introduction	57
5.3	Resets	57
5.4	System Configuration Options Register	60
5.5	Arm/Reset COP Timer Circuitry Register	61
5.6	Configuration Control Register	62
5.7	Highest Priority I-Bit Interrupt and Miscellaneous Register	63

5.2 Introduction

This section describes the MC68HC11ED0 reset and interrupt structure.

5.3 Resets

The MC68HC11ED0 has three reset vectors and 18 interrupt vectors. The reset vectors are:

- $\overline{\text{RESET}}$ or power-on reset
- Clock monitor fail
- Computer operating properly (COP) failure

The 18 interrupt vectors service 22 interrupt sources (three non-maskable, 19 maskable). The three non-maskable interrupt sources are:

- $\overline{\text{XIRQ}}$ pin (X-bit interrupt)
- Illegal opcode trap
- Software interrupt

www.DataSheet4U.com

On-chip peripheral systems generate maskable interrupts, which are recognized only if the global interrupt mask bit (I) in the condition code register (CCR) is clear. Maskable interrupts are prioritized according to a default arrangement; however, any one source can be elevated to the highest maskable priority position by a software-accessible control register (HPRIO). HPRIO can be written at any time, provided bit I in the CCR is set.

Nineteen interrupt sources in the MC68HC11ED0 are subject to masking by the global interrupt mask bit (bit I in the CCR). In addition to the global I bit, all of these sources, except the external interrupt ($\overline{\text{IRQ}}$) pin, are controlled by local enable bits in the control registers. Most interrupt sources in M68HC11 devices have separate interrupt vectors; therefore there is usually no need for software to poll control registers to determine the cause of an interrupt.

For some interrupt sources, such as the serial communications interface (SCI) interrupts, the flags are automatically cleared during the normal course of responding to the interrupt requests. For example, the RDRF flag in the SCI system is cleared by the automatic clearing mechanism invoked by a read of the SCI status register while RDRF is set, followed by a read of the SCI data register. The normal response to an RDRF interrupt request would be to read the SCI status register to check for receive errors, then to read the received data from the SCI data register. These two steps satisfy the automatic clearing mechanism without requiring any special instructions.

Refer to [Table 5-1](#) for interrupt and reset vector assignments.

Table 5-1. Interrupt and Reset Vector Assignments

Vector Address	Interrupt Source	CCR Mask Bit	Local Mask	Priority (1 = High)
\$FFC0, \$FFC1 – \$FFD4, \$FFD5	Reserved	—	—	—
\$FFD6, \$FFD7	SCI serial system: <ul style="list-style-type: none"> • SCI receive data register full • SCI receiver overrun • SCI transmit data register empty • SCI transmit complete • SCI idle line detect 	I	RIE RIE TIE TCIE ILIE	19 20 21 22 23
\$FFD8, \$FFD9	SPI serial transfer complete	I	SPIE	18
\$FFDA, \$FFDB	Pulse accumulator input edge	I	PAII	17
\$FFDC, \$FFDD	Pulse accumulator overflow	I	PAOVI	16
\$FFDE, \$FFDF	Timer overflow	I	TOI	15
\$FFE0, \$FFE1	Timer input capture 4/output compare 5	I	I4/O5I	14
\$FFE2, \$FFE3	Timer output compare 4	I	OC4I	13
\$FFE4, \$FFE5	Timer output compare 3	I	OC3I	12
\$FFE6, \$FFE7	Timer output compare 2	I	OC2I	11
\$FFE8, \$FFE9	Timer output compare 1	I	OC1I	10
\$FFEA, \$FFEB	Timer input capture 3	I	IC3I	9
\$FFEC, \$FFED	Timer input capture 2	I	IC2I	8
\$FFEE, \$FFEF	Timer input capture 1	I	IC1I	7
\$FFF0, \$FFF1	Real-time interrupt	I	RTII	6
\$FFF2, \$FFF3	$\overline{\text{IRQ}}$ (external pin)	I	None	5
\$FFF4, \$FFF5	$\overline{\text{XIRQ}}$ pin	X	None	4
\$FFF6, \$FFF7	Software interrupt	None	None	Note 1
\$FFF8, \$FFF9	Illegal opcode trap	None	None	Note 1
\$FFFA, \$FFFB	COP failure	None	NOCOP	3
\$FFFC, \$FFFD	Clock monitor fail	None	CME	2
\$FFFE, \$FFFF	$\overline{\text{RESET}}$	None	None	1

1. Same level as an instruction

5.4 System Configuration Options Register

Refer to [Figure 5-1](#) for a description of the system configuration options register (OPTION)

www.DataSheet4U.com

Address: \$0039

	Bit 7	6	5	4	3	2	1	Bit 0
Read:			IRQE ⁽¹⁾	DLY ⁽¹⁾	CME		CR1 ⁽¹⁾	CR0 ⁽¹⁾
Write:								
Reset:	0	0	0	1	0	0	0	0

Note 1. Can be written only once in the first 64 cycles out of reset in normal modes or at any time

in special modes.

 = Unimplemented

Figure 5-1. System Configuration Options Register (OPTION)

Bits [7:6] — Unimplemented

Always read as 0

IRQE — $\overline{\text{IRQ}}$ Select Edge Sensitive Only Bit

0 = Low level recognition

1 = Falling edge recognition

DLY — Enable Oscillator Startup Delay on Exit from Stop Mode Bit

0 = No stabilization delay on exit from stop mode

1 = Stabilization delay enabled on exit from stop mode

CME — Clock Monitor Enable Bit

0 = Clock monitor disabled; slow clocks can be used

1 = Slow or stopped clocks cause clock failure reset.

Bit 2 — Unimplemented

Always reads 0

CR[1:0] — COP Timer Rate Select Bit

Refer to description of the NOCOP bit in [5.6 Configuration Control Register](#).

Table 5-2. COP Timer Rate Select

CR[1:0]	Rate Selected	XTAL = 4.0 MHz Timeout – 0 ms, + 32.8 ms	XTAL = 8.0 MHz Timeout – 0 ms, + 16.4 ms	XTAL = 12.0 MHz Timeout – 0 ms, + 10.9 ms
0 0	$2^{15} \div E$	32.768 ms	16.384 ms	10.923 ms
0 1	$2^{17} \div E$	131.07 ms	65.536 ms	43.691 ms
1 0	$2^{19} \div E$	524.29 ms	262.14 ms	174.76 ms
1 1	$2^{21} \div E$	2.1 s	1.049 s	699.05 ms
	E =	1.0 MHz	2.0 MHz	3.0 MHz

5.5 Arm/Reset COP Timer Circuitry Register

Refer to [Figure 5-2](#) for a description of the arm/reset COP timer circuitry register (COPRST).

Address: \$003A

	Bit 7	6	5	4	3	2	1	Bit 0
Read:	Bit 7	Bit 6	Bit 6	Bit 4	Bit 3	Bit 2	Bit 1	Bit 0
Write:								
Reset:	0	0	0	0	0	0	0	0

Figure 5-2. Arm/Reset COP Timer Circuitry Register (COPRST)

Write \$55 to COPRST to arm COP watchdog clearing mechanism. Write \$AA to COPRST to reset COP watchdog. Refer to description of the NOCOP bit in [5.6 Configuration Control Register](#).

5.6 Configuration Control Register

In many M68HC11 devices the configuration control register (CONFIG) is used to define various system functions. In the MC68HC11ED0, CONFIG controls only one microcontroller (MCU) function. The NOCOP bit disables the COP watchdog circuit when it is set. Refer to [Table 5-2](#) and [Figure 5-3](#).

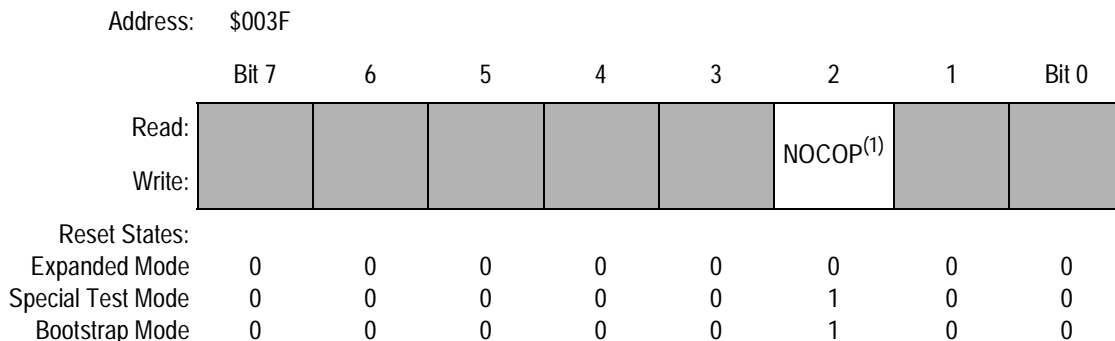

1. NOCOP must be written during the first 64 cycles after reset in normal modes (SMOD = 0) or at any time in special modes (SMOD = 1).

 = Unimplemented

Figure 5-3. System Configuration Register (CONFIG)

Bits [7:3] — Unimplemented

Always read as 0

NOCOP — COP System Disable Bit

Resets to programmed value

0 = COP enabled (forces reset on timeout)

1 = COP disabled (does not force reset on timeout)

Bits [1:0] — Unimplemented

Always read as 0

5.7 Highest Priority I-Bit Interrupt and Miscellaneous Register

Address: \$003C

	Bit 7	6	5	4	3	2	1	Bit 0
Read:	RBOOT ⁽¹⁾	SMOD ⁽¹⁾	MDA ⁽¹⁾	IRVNE	PSEL3	PSEL2	PSEL1	PSEL0
Write:								
Reset:	U	U	U	U	0	1	0	1

1. RBOOT, SMOD, and MDA reset depends on power-up initialization mode and can only be written only in special mode.

U = Undefined

Figure 5-4. Highest Priority I-Bit Interrupt and Miscellaneous Register (HPRIO)

RBOOT — Read Bootstrap ROM Bit

Refer to [Section 4. Operating Modes and On-Chip Memory](#).

SMOD — Special Mode Select Bit

Refer to [Section 4. Operating Modes and On-Chip Memory](#).

MDA — Mode Select A Bit

Refer to [Section 4. Operating Modes and On-Chip Memory](#).

IRVNE — Internal Read Visibility/Not E Bit

Refer to [Section 4. Operating Modes and On-Chip Memory](#).

PSEL[3:0] — Priority Select Bits

Can be written only while the I bit in the CCR is set (interrupts disabled). These bits select one interrupt source to be elevated above all other I bit related sources. See [Table 5-3](#).

Table 5-3. Highest Priority Interrupt Selection

PSEL[3:0]	Interrupt Source Promoted
0 0 0 0	Timer overflow
0 0 0 1	Pulse accumulator overflow
0 0 1 0	Pulse accumulator input edge
0 0 1 1	SPI serial transfer complete
0 1 0 0	SCI serial system
0 1 0 1	Reserved (default to $\overline{\text{IRQ}}$)
0 1 1 0	$\overline{\text{IRQ}}$ (external pin)
0 1 1 1	Real-time interrupt
1 0 0 0	Timer input capture 1
1 0 0 1	Timer input capture 2
1 0 1 0	Timer input capture 3
1 0 1 1	Timer output compare 1
1 1 0 0	Timer output compare 2
1 1 0 1	Timer output compare 3
1 1 1 0	Timer output compare 4
1 1 1 1	Timer input capture 4/output compare 5

www.DataSheet4U.com

Section 6. Parallel Input/Output (I/O) Ports

www.DataSheet4U.com

6.1 Contents

6.2	Introduction	65
6.3	Port A Data Register	66
6.4	Pulse Accumulator Control Register	67
6.5	Port D Data Register	68
6.6	Port D Data Direction Register	69

6.2 Introduction

The MC68HC11ED0 has up to 14 input/output (I/O) lines. The address/data bus of this microcontroller (MCU) is multiplexed and has no I/O ports associated with it. **Table 6-1** provides a summary of the configuration and features of each port.

Table 6-1. Input/Output Ports

Port	Input Pins	Output Pins	Bidirectional Pins	Shared Functions
Port A	3	3	2	Timer
Port D	—	—	6	Serial communications interface (SCI) and serial peripheral interface (SPI)

NOTE: Do not confuse pin function with the electrical state of the pin at reset. All general-purpose I/O pins configured as inputs at reset are in a high-impedance state and the contents of port data registers is undefined. In port descriptions, a U indicates this condition. The pin function is mode dependent.

6.3 Port A Data Register

Refer to [Figure 6-1](#) for a description of the port A data register (PORTA).

www.DataSheet4U.com

Address: \$0000

	Bit 7	6	5	4	3	2	1	Bit 0
Read:	PA7	PA6	PA5	PA4	PA3	PA2	PA1	PA0
Write:								
Reset:	U	0	0	0	U	U	U	U
Alternate Function:	PAI	OC2	OC3	OC4	IC4/OC5	IC1	IC2	IC3
And/or:	OC1	OC1	OC1	OC1	OC1	—	—	—

U = Undefined

Figure 6-1. Port A Data Register (PORTA)

To enable PA3 as fourth input capture, set I4/O5 bit in the pulse accumulator control register (PACTL). Otherwise, PA3 is configured as a fifth output compare out of reset, with bit I4/O5 being cleared. If the DDRA3 bit in PACTL is set (configuring PA3 as an output), and IC4 is enabled, writes to PA3 cause edges on the pin to result in input captures. Writing to I4/O5 has no effect when the I4/O5 register is acting as IC4. PA7 drives the pulse accumulator input but also can be configured for general-purpose I/O or output compare. DDRA7 bit in PACTL configures PA7 for either input or output.

NOTE: *Even when PA7 is configured as an output, the pin still drives the pulse accumulator input.*

6.4 Pulse Accumulator Control Register

Refer to [Figure 6-2](#) for a description of the pulse accumulator control register (PACTL).

www.DataSheet4U.com

Address: \$0026

	Bit 7	6	5	4	3	2	1	Bit 0
Read:	DDRA7	PAEN	PAMOD	PEDGE	DDRA3	I4/O5	RTR1	RTR0
Write:								
Reset:	0	0	0	0	0	0	0	0

Figure 6-2. Pulse Accumulator Control Register (PACTL)

DDRA7 — Data Direction for Port A Bit 7

- 0 = Input
- 1 = Output

PAEN — Pulse Accumulator System Enable Bit

Refer to [9.4 Pulse Accumulator](#).

PAMOD — Pulse Accumulator Mode Bit

Refer to [9.4 Pulse Accumulator](#).

PEDGE — Pulse Accumulator Edge Control Bit

Refer to [9.4 Pulse Accumulator](#).

DDRA3 — Data Direction for Port A Bit 3

This bit is overridden if an output compare function is configured to control the PA3 pin.

- 0 = Input
- 1 = Output

I4/O5 — Input Capture 4/Output Compare 5 Bit

Refer to [Section 9. Timing System](#).

RTR[1:0] — Real-Time Interrupt (RTI) Rate Select Bits

Refer to [9.4 Pulse Accumulator](#).

6.5 Port D Data Register

Refer to [Figure 6-3](#) for a description of the port D data register (PORTD).

www.DataSheet4U.com

Address: \$0008

	Bit 7	6	5	4	3	2	1	Bit 0
Read:			PD5	PD4	PD3	PD2	PD1	PD0
Write:								
Reset:	0	0	U	U	U	U	U	U
Alternate Function:	—	—	\overline{SS}	SCK	MOSI	MISO	TxD	RxD

= Unimplemented U = Undefined

Figure 6-3. Port D Data Register (PORTD)

Freescale Semiconductor, Inc.

6.6 Port D Data Direction Register

Refer to [Figure 6-4](#) for a description of the port D data direction register (DDRD)

www.DataSheet4U.com

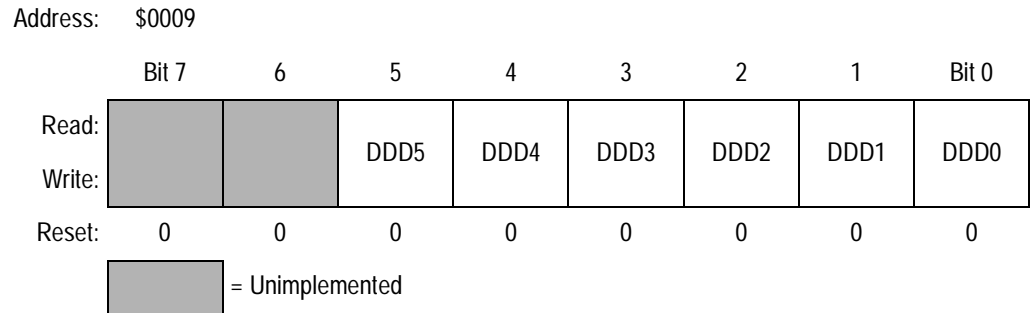

Figure 6-4. Port D Data Direction Register (DDRD)

Bits [7:6] — Unimplemented

Always read 0

DDD[5:0] — Port D Data Direction Bits

0 = Input

1 = Output

NOTE: When the serial peripheral interface (SPI) system is in slave mode, DDD5 has no meaning or effect. When the SPI system is in master mode, DDD5 determines whether bit 5 of PORTD is an error detect input (DDD5 = 0) or a general-purpose output (DDD5 = 1). If the SPI system is enabled and expects any of bits [4:2] to be an input, that bit will be an input regardless of the state of the associated DDR bit. If any of bits [4:2] are expected to be outputs, that bit will be an output **only** if the associated DDR bit is set.

Section 7. Serial Communications Interface (SCI)

www.DataSheet4U.com

7.1 Contents

7.2	Introduction	71
7.3	SCI Registers	74
7.3.1	Baud Rate Register	74
7.3.2	Serial Communications Control Register 1	77
7.3.3	Serial Communications Control Register 2	78
7.3.4	Serial Communication Status Register	79
7.3.5	Serial Communications Data Register	80

7.2 Introduction

The serial communications interface (SCI) is a universal asynchronous receiver transmitter (UART), one of two independent serial input/output (I/O) subsystems in the MC68HC11ED0. It has a standard non-return to zero (NRZ) format (one start bit, eight or nine data bits, and one stop bit) and several baud rates available. The SCI transmitter and receiver are independent, but use the same data format and bit rate.

Refer to [Figure 7-1](#) and [Figure 7-2](#).

Serial Communications Interface (SCI)

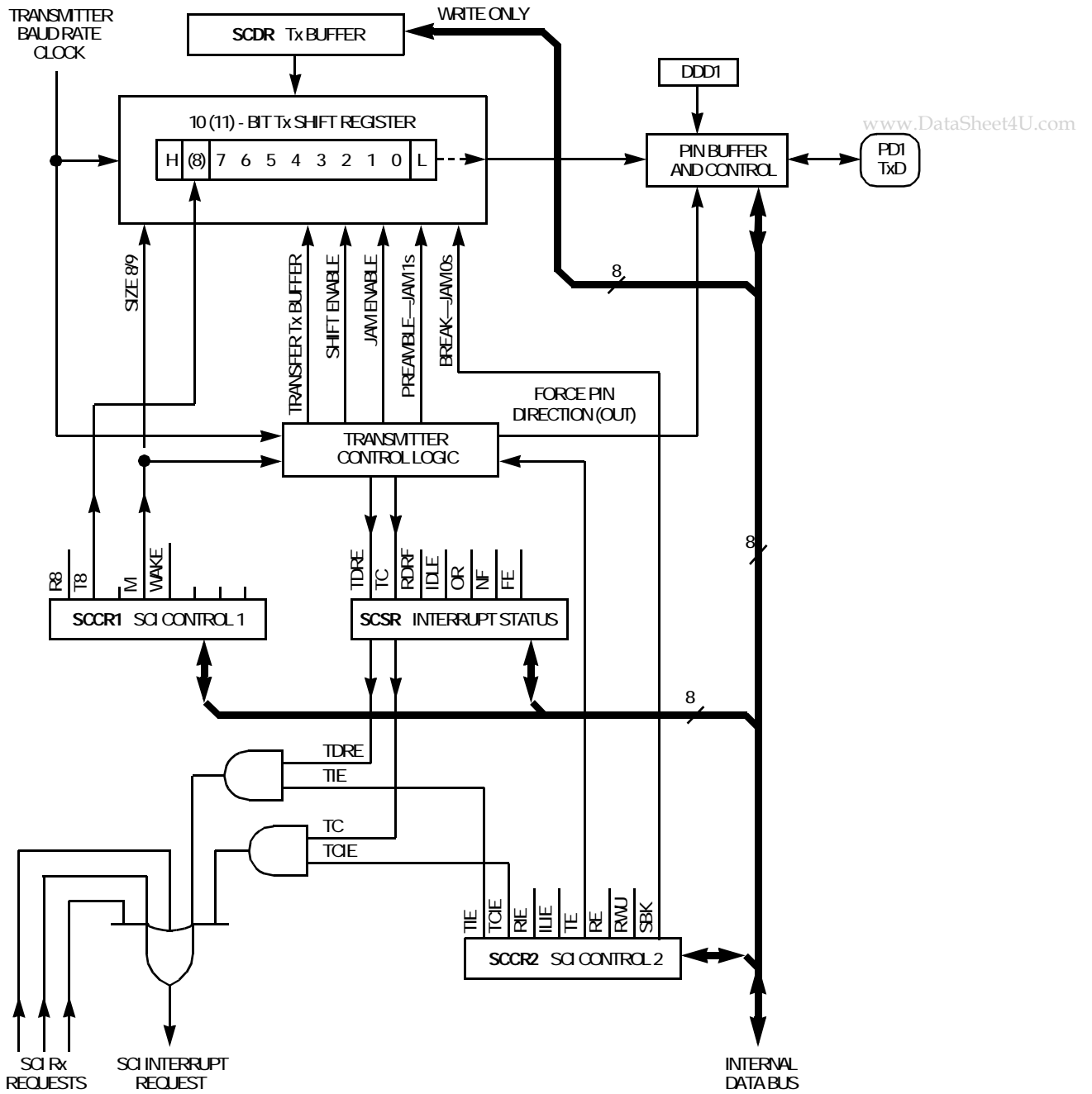

Figure 7-1. SCI Transmitter Block Diagram

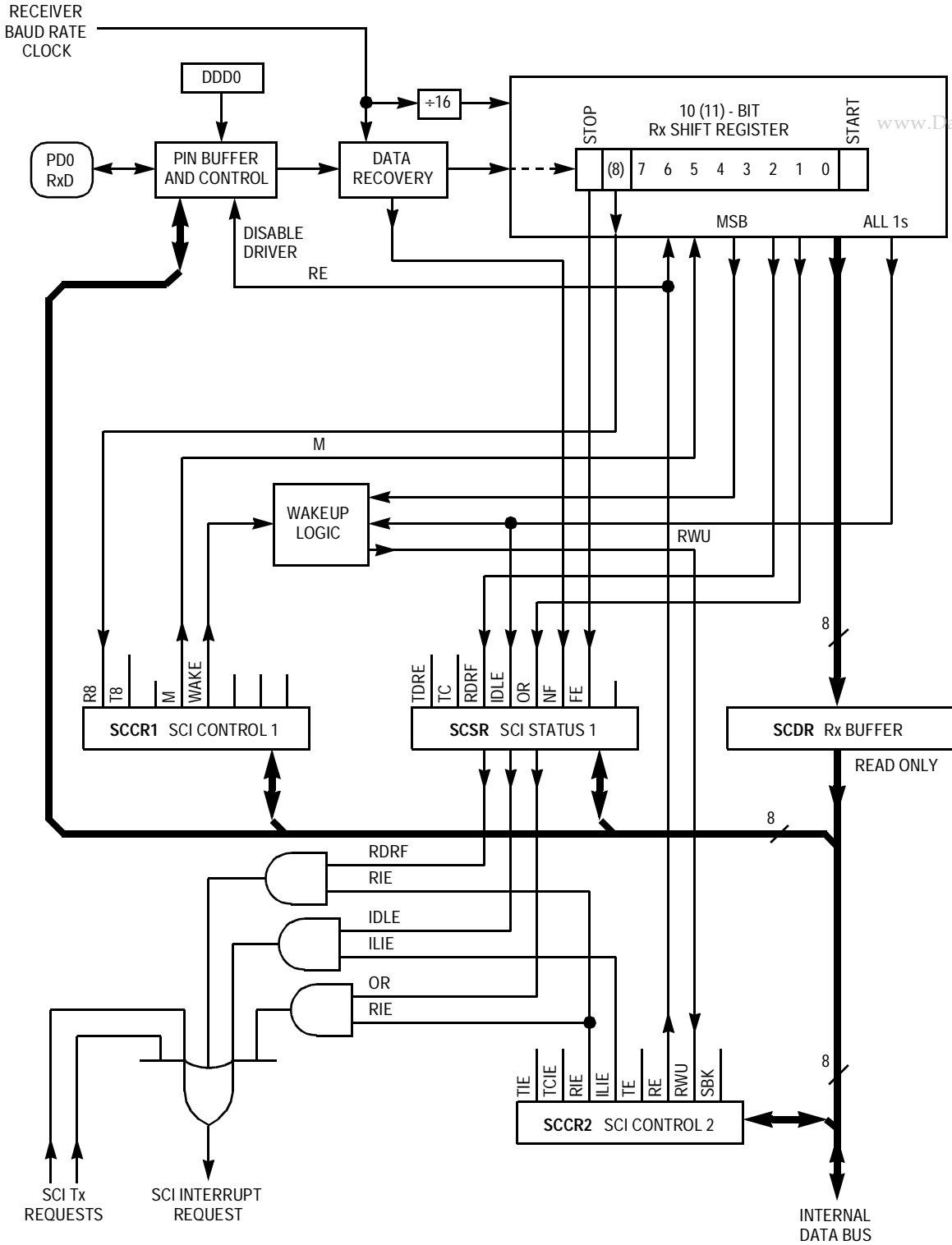

Figure 7-2. SCI Receiver Block Diagram

7.3 SCI Registers

This subsection describes the SCI registers.

www.DataSheet4U.com

7.3.1 Baud Rate Register

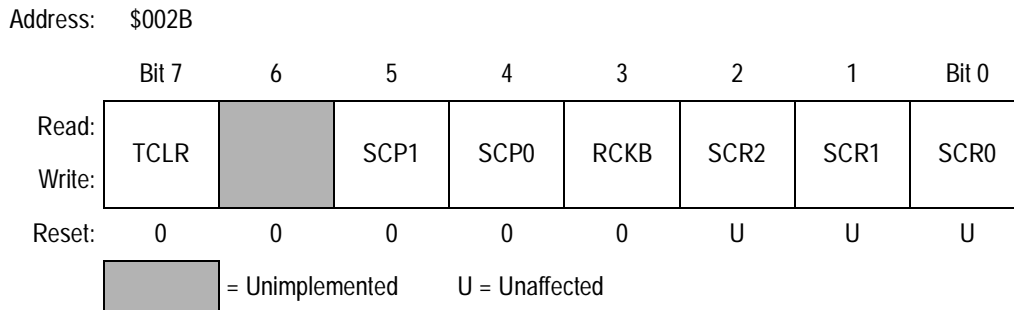

Figure 7-3. Baud Rate Register (BAUD)

TCLR — Clear Baud Rate Counter Bit

TCLR can be set only in test modes.

- 1 = Clear baud rate counter chain for testing purposes
- 0 = Normal SCI operation

SCP[1:0] — SCI Baud Rate Prescaler Select Bits

Refer to [Table 7-1](#) for the prescaler rates. The shaded boxes contain the prescaler rates used in the [Table 7-2](#).

Table 7-1. Prescaler Rates

SCP[1:0]	Divide E Clock By	Crystal Frequency in MHz		
		4.0 MHz (Baud)	8.0 MHz (Baud)	12.0 MHz (Baud)
0 0	1	62.50 k	125.0 k	187.5 k
0 1	3	20.83 k	41.67 k	62.5 k
1 0	4	15.625 k	31.25 k	46.88 k
1 1	13	4800	9600	14.4 k

RCKB — SCI Baud Rate Clock Check Bit

RCKB can be set only in test modes.

1 = Exclusive-OR of the RT clock driven out TxD pin for testing purposes

0 = Normal SCI operation

www.DataSheet4U.com

SCR[2:0] — SCI Baud Rate Select Bits

These bits select receiver and transmitter bit rates based on output from the baud rate prescaler stage. Refer to [Table 7-2](#) and [Figure 7-4](#).

Table 7-2. Baud Rates

SCR[2:0]	Divide Prescaler By	Baud Rate (Prescaler output from Table 7-1)		
		4800	9600	14.4 k
0 0 0	1	4800	9600	14.4 k
0 0 1	2	2400	4800	7200
0 1 0	4	1200	2400	3600
0 1 1	8	600	1200	1800
1 0 0	16	300	600	1200
1 0 1	32	150	300	450
1 1 0	64	75	150	225
1 1 1	128	37.5	75	112.5

Serial Communications Interface (SCI)

Freescale Semiconductor, Inc.

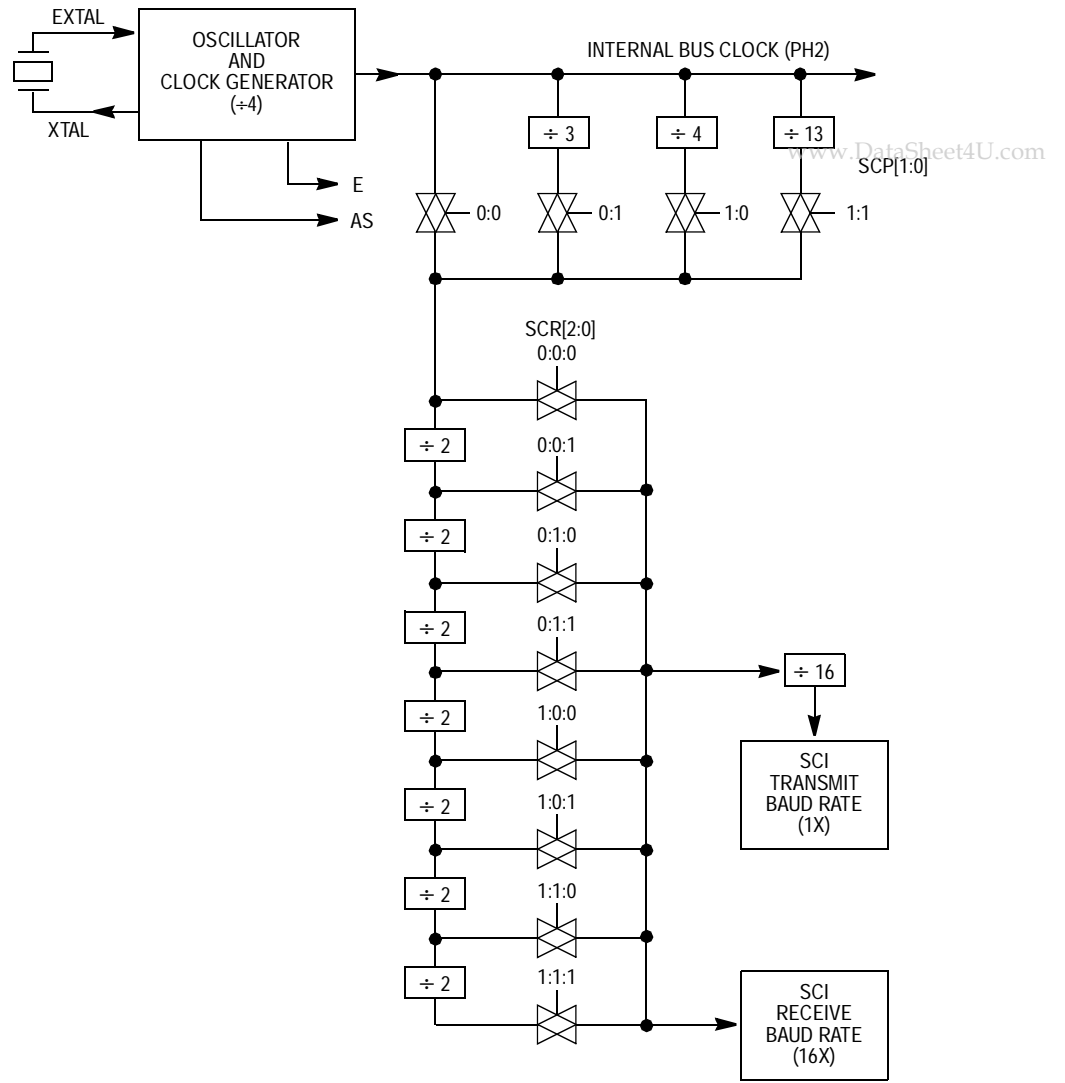

Figure 7-4. SCI Baud Rate Generator Clock Diagram

7.3.2 Serial Communications Control Register 1

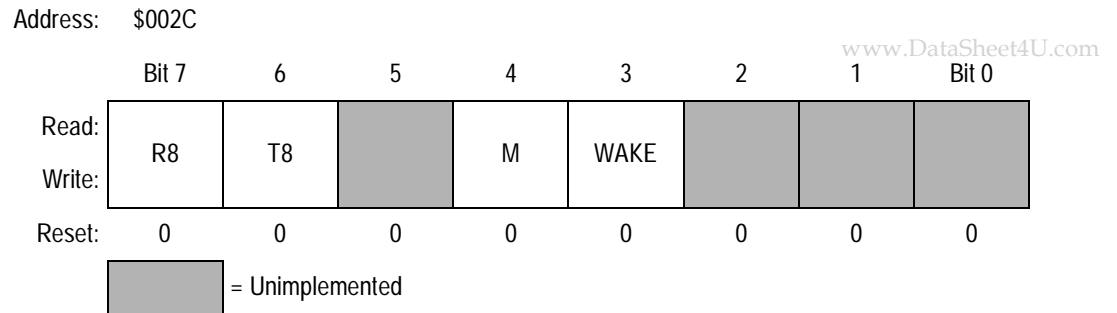

Figure 7-5. Serial Communications Control Register 1 (SCCR1)

R8 — Receive Data Bit 8

If M bit is set, R8 stores the ninth bit in the receive data character.

T8 — Transmit Data Bit 8

If M bit is set, T8 stores the ninth bit in the transmit data character.

Bit 5 — Unimplemented

Always reads 0

M — Mode Bit (select character format)

1 = Start bit, 8 data bits, 1 stop bit

1 = Start bit, 9 data bits, 1 stop bit

WAKE — Wakeup by Address Mark/Idle Bit

0 = Wakeup by IDLE line recognition

1 = Wakeup by address mark (most significant data bit set)

Bits [2:0] — Unimplemented

Always read 0

7.3.3 Serial Communications Control Register 2

Address: \$002D

	Bit 7	6	5	4	3	2	1	0
Read:	TIE	TCIE	RIE	ILIE	TE	RE	RWU	SBK
Write:								
Reset:	0	0	0	0	0	0	0	0

Figure 7-6. Serial Communications Control Register 2 (SCCR2)

TIE — Transmit Interrupt Enable Bit

0 = TDRE interrupts disabled

1 = SCI interrupt requested when TDRE status flag is set

TCIE — Transmit Complete Interrupt Enable Bit

0 = TC interrupts disabled

1 = SCI interrupt requested when TC status flag is set

RIE — Receiver Interrupt Enable Bit

0 = RDRF and OR interrupts disabled

1 = SCI interrupt requested when RDRF flag or the OR status flag is set

ILIE — Idle-Line Interrupt Enable Bit

0 = IDLE interrupts disabled

1 = SCI interrupt requested when IDLE status flag is set

TE — Transmitter Enable Bit

0 = Transmitter disabled

1 = Transmitter enabled

RE — Receiver Enable Bit

0 = Receiver disabled

1 = Receiver enabled

RWU — Receiver Wakeup Control Bit

0 = Normal SCI receiver

1 = Wakeup enabled and receiver interrupts inhibited

SBK — Send Break Bit

0 = Break generator off

1 = Break codes generated as long as SBK = 1

7.3.4 Serial Communication Status Register

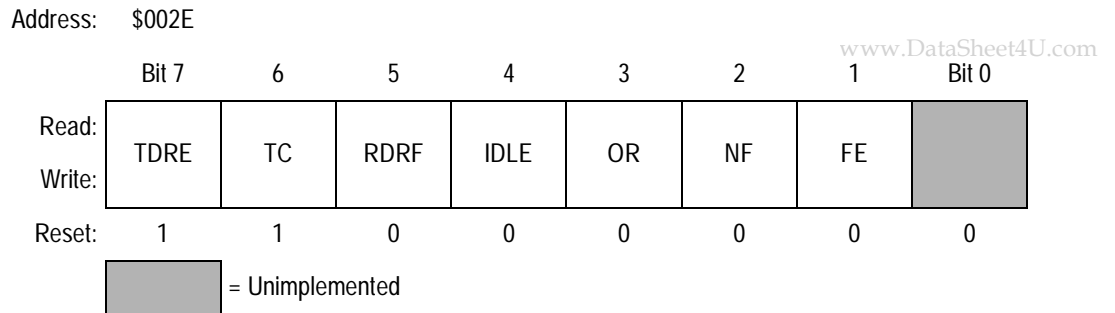

Figure 7-7. Serial Communications Status Register (SCSR)

TDRE — Transmit Data Register Empty Flag

This flag is set when SCDR is empty. Clear the TDRE flag by reading SCSR and then writing to SCDR.

- 0 = SCDR busy
- 1 = SCDR empty

TC — Transmit Complete Flag

This flag is set when the transmitter is idle (no data, preamble, or break transmission in progress). Clear the TC flag by reading SCSR and then writing to SCDR.

- 0 = Transmitter busy
- 1 = Transmitter idle

RDRF — Receive Data Register Full Flag

This flag is set if a received character is ready to be read from SCDR. Clear the RDRF flag by reading SCSR and then reading SCDR.

- 0 = SCDR empty
- 1 = SCDR full

IDLE — Idle Line Detected Flag

This flag is set if the RxD line is idle. Once cleared, IDLE is not set again until the RxD line has been active and becomes idle again. The IDLE flag is inhibited when RWU = 1. Clear IDLE by reading SCSR and then reading SCDR.

- 0 = RxD line active
- 1 = RxD line idle

Serial Communications Interface (SCI)

OR — Overrun Error Flag

OR is set if a new character is received before a previously received character is read from SCDR. Clear the OR flag by reading SCSR and then reading SCDR.

www.DataSheet4U.com

- 0 = No overrun
- 1 = Overrun detected

NF — Noise Error Flag

NF is set if majority sample logic detects anything other than a unanimous decision. Clear NF by reading SCSR and then reading SCDR.

- 0 = Unanimous decision
- 1 = Noise detected

FE — Framing Error Flag

FE is set when a 0 is detected where a stop bit was expected. Clear the FE flag by reading SCSR and then reading SCDR.

- 0 = Stop bit detected
- 1 = Zero detected

Bit 0 — Unimplemented

Always reads 0

7.3.5 Serial Communications Data Register

Address: \$002F

	Bit 7	6	5	4	3	2	1	Bit 0
Read:	R7/T7	R6/T6	R5/T5	R4/T4	R3/T3	R2/T2	R1/T1	R0/T0
Write:								
Reset:	Unaffected by reset							

Figure 7-8. Serial Communications Data Register (SCDR)

NOTE: *SCI receive and transmit data are double buffered. Reads of SCDR access the receive data buffer and writes access the transmit data buffer.*

Section 8. Serial Peripheral Interface (SPI)

www.DataSheet4U.com

8.1 Contents

8.2	Introduction	81
8.3	SPI Registers	83
8.3.1	Serial Peripheral Control Register	83
8.3.2	Serial Peripheral Status Register	85
8.3.3	Serial Peripheral Data I/O Register	86

8.2 Introduction

The serial peripheral interface (SPI) allows the microcontroller unit (MCU) to communicate synchronously with peripheral devices and other microprocessors. When configured as a master, data transfer rates can be as high as one-half the E clock rate (1.5 Mbits per second for a 3-MHz bus frequency). When configured as a slave, data transfers can be as fast as the E-clock rate (3 Mbits per second for a 3-MHz bus frequency).

When the SPI is enabled, all pins that are defined by the configuration as inputs are inputs regardless of the state of the DDR bits of those pins. All pins that are defined as outputs will be outputs only if the DDR bits for those pins are set to 1. Any SPI output whose corresponding DDR bit is cleared to 0 can be used as a general-purpose input. If the SPI system is in master mode and DDRD bit 5 is set to 1, the port D bit 5 pin becomes a general-purpose output instead of the \overline{SS} input to the SPI system. The MODF mode error flag function for which \overline{SS} was used becomes disabled to avoid interference between the general-purpose output function and the SPI system.

Refer to [Figure 8-1](#), which shows the SPI block diagram.

Serial Peripheral Interface (SPI)

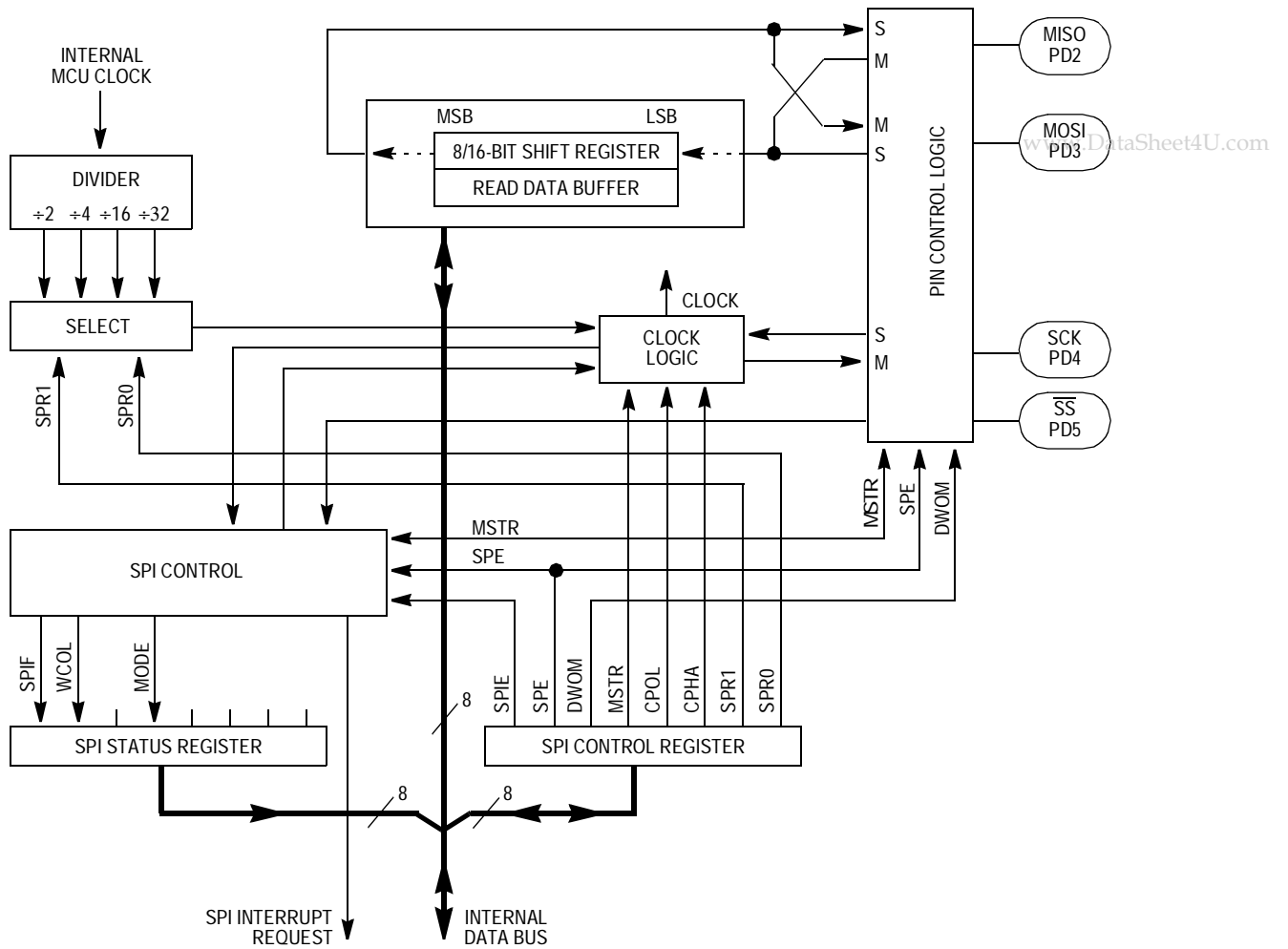

Figure 8-1. SPI Block Diagram

Freescale Semiconductor, Inc.

8.3 SPI Registers

This subsection describes the SPI registers.

www.DataSheet4U.com

8.3.1 Serial Peripheral Control Register

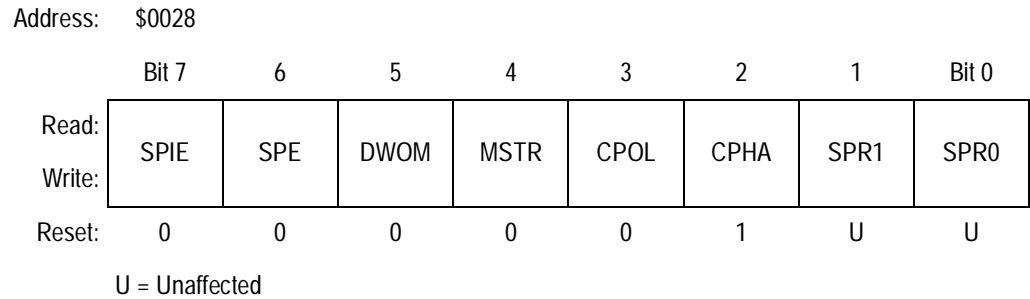

Figure 8-2. Serial Peripheral Control Register (SPCR)

SPIE — Serial Peripheral Interrupt Enable Bit

0 = SPI interrupts disabled

1 = SPI interrupts enabled

SPE — Serial Peripheral System Enable Bit

0 = SPI off

1 = SPI on

DWOM — Port D Wired-OR Mode Option Bit for Port D Pins PD[5:2]

0 = Normal CMOS outputs

1 = Open-drain outputs

MSTR — Master Mode Select Bit

0 = Slave mode

1 = Master mode

CPOL and CPHA — Clock Polarity Bit and Clock Phase Bit

Refer to [Figure 8-3](#).

Serial Peripheral Interface (SPI)

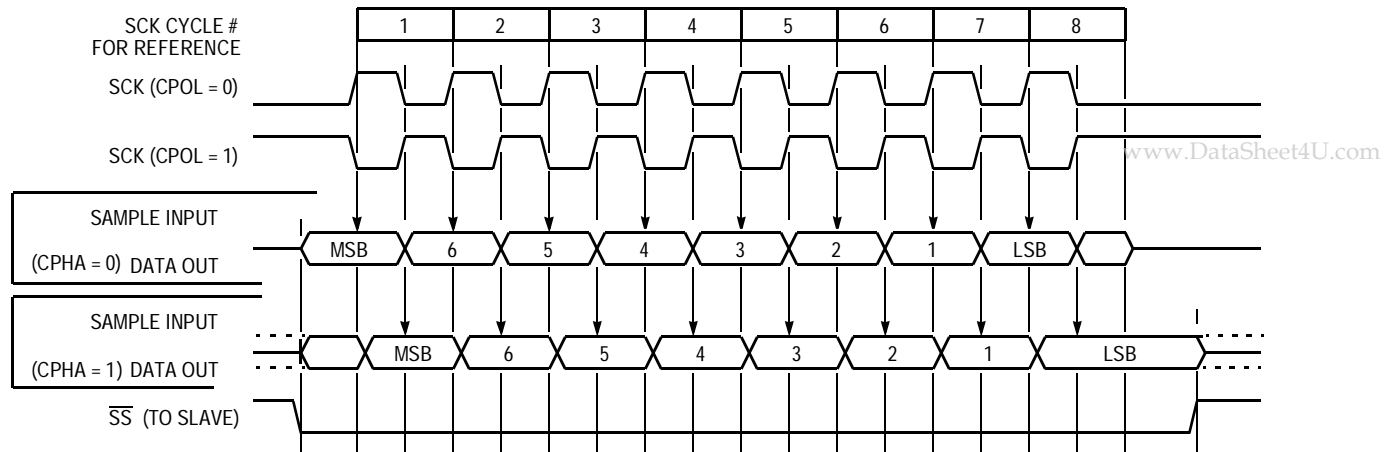

Figure 8-3. SPI Transfer Format

SPR[1:0] — SPI Clock Rate Select Bits

Refer to [Table 8-1](#).

Table 8-1. SPI Clock Rate Selects

SPR[1:0]	Divide E Clock By	Frequency at E = 1 MHz	Frequency at E = 2 MHz	Frequency at E = 3 MHz
0 0	2	500 kHz	1.0 MHz	1.5 MHz
0 1	4	250 kHz	500 kHz	750 kHz
1 0	16	125 kHz	125 kHz	375 kHz
1 1	32	62.5 kHz	62.5 kHz	187.5 kHz

8.3.2 Serial Peripheral Status Register

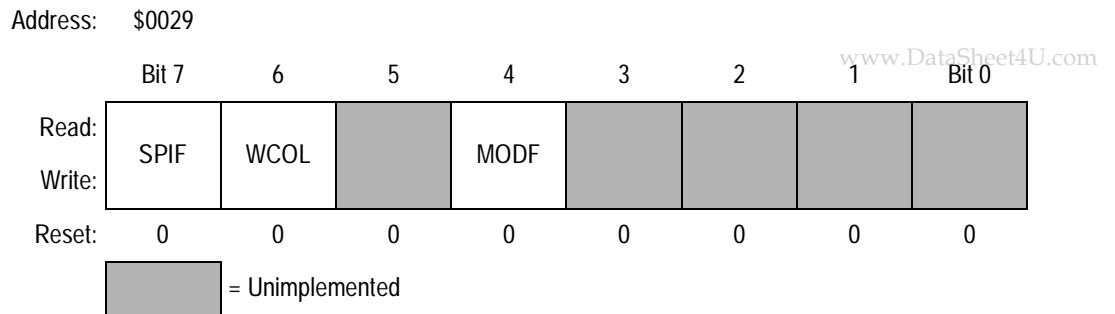

Figure 8-4. Serial Peripheral Status Register (SPSR)

SPIF — SPI Transfer Complete Flag

This flag is set when an SPI transfer is complete (after eight SCK cycles in a data transfer). Clear this flag by reading SPSR, then access SPDR.

- 0 = No SPI transfer complete or SPI transfer still in progress
- 1 = SPI transfer complete

WCOL — Write Collision Error Flag

This flag is set if the MCU tries to write data into SPDR while an SPI data transfer is in progress. Clear this flag by reading SPSR, then access SPDR.

- 0 = No write collision error
- 1 = SPDR written while SPI transfer in progress

Bit 5 — Unimplemented

Always reads 0

MODF — Mode Fault Bit (mode fault terminates SPI operation)

Set when \overline{SS} is pulled low while MSTR = 1. Cleared by SPSR read followed by SPCR write.

- 0 = No mode fault error
- 1 = \overline{SS} pulled low in master mode

Bits [3:0] — Unimplemented

Always read 0

Serial Peripheral Interface (SPI)

8.3.3 Serial Peripheral Data I/O Register

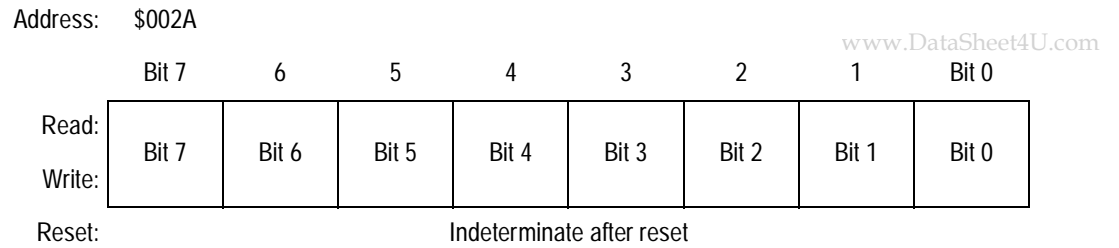

Figure 8-5. Serial Peripheral Data I/O Register (SPDR)

SPI is double buffered in and single buffered out.

Section 9. Timing System www.DataSheet4U.com

9.1 Contents

9.2	Introduction	88
9.3	Timer Registers	91
9.3.1	Timer Compare Force Register	91
9.3.2	Output Compare 1 Mask Register	92
9.3.3	Output Compare 1 Data Register	92
9.3.4	Timer Count Register	93
9.3.5	Timer Input Capture Registers	94
9.3.6	Timer Output Compare Registers	95
9.3.7	Timer Input Capture 4/Output Compare 5 Register	96
9.3.8	Timer Control Register 1	97
9.3.9	Timer Control Register 2	98
9.3.10	Timer Interrupt Mask 1 Register	99
9.3.11	Timer Interrupt Flag 1 Register	100
9.3.12	Timer Interrupt Mask 2 Register	100
9.3.13	Timer Interrupt Flag Register 2	102
9.4	Pulse Accumulator	103
9.4.1	Pulse Accumulator Control Register	104
9.4.2	Pulse Accumulator Counter Register	106

9.2 Introduction

The timing system is based on a free-running 16-bit counter with a four-stage programmable prescaler. A timer overflow function allows software to extend the system's timing capability beyond the counter's 16-bit range. www.DataSheet4U.com

The timer has:

- Three channels for input capture
- Four channels for output compare
- One channel that can be configured as a fourth input capture or a fifth output compare

In addition, the timing system includes pulse accumulator and real-time interrupt (RTI) functions, as well as a clock monitor function, which can be used to detect clock failures that are not detected by the computer operating properly (COP. Refer to [9.4 Pulse Accumulator](#) for further information about these functions.

[Table 9-1](#) provides a summary of the crystal-related frequencies and periods. A block diagram of the timer system is shown in [Figure 9-1](#).

Table 9-1. Timer Summary

Control Bits	Common System Frequencies			Definition
	4.0 MHz	8.0 MHz	12.0 MHz	XTAL
	1.0 MHz	2.0 MHz	3.0 MHz	E
PR[1:0]	Main Timer Count Rates (Period Length)			
0 0 1 count — overflow —	1000 ns 65.536 ms	500 ns 32.768 ms	333 ns 21.845 ms	1 ÷ E 2 ¹⁶ ÷ E
0 1 1 count — overflow —	4.0 μs 262.14 ms	2.0 μs 131.07 ms	1.333 μs 87.381 ms	4 ÷ E 2 ¹⁸ ÷ E
1 0 1 count — overflow —	8.0 μs 524.28 ms	4.0 μs 262.14 ms	2.667 μs 174.76 ms	8 ÷ E 2 ¹⁹ ÷ E
1 1 1 count — overflow —	16.0 μs 1.049 s	8.0 μs 524.29 ms	5.333 μs 349.52 ms	16 ÷ E 2 ²⁰ ÷ E
RTR[1:0]	Periodic (RTI) Interrupt Rates (Period Length)			
0 0	8.192 ms	4.096 ms	2.731 ms	2 ¹³ ÷ E
0 1	16.384 ms	8.192 ms	5.461 ms	2 ¹⁴ ÷ E
1 0	32.768 ms	16.384 ms	10.923 ms	2 ¹⁵ ÷ E
1 1	65.536 ms	32.768 ms	21.845 ms	2 ¹⁶ ÷ E
CR[1:0]	COP Watchdog Timeout Rates (Period Length)			
0 0	32.768 ms	16.384 ms	10.923 ms	2 ¹⁵ ÷ E
0 1	131.072 ms	65.536 ms	43.691 ms	2 ¹⁷ ÷ E
1 0	524.288 ms	262.14 ms	174.76 ms	2 ¹⁹ ÷ E
1 1	2.098 s	1.049 s	699.05 ms	2 ²¹ ÷ E
Timeout tolerance (-0 ms/+...)	32.8 ms	16.4 ms	10.9 ms	2 ¹⁵ ÷ E

Timing System

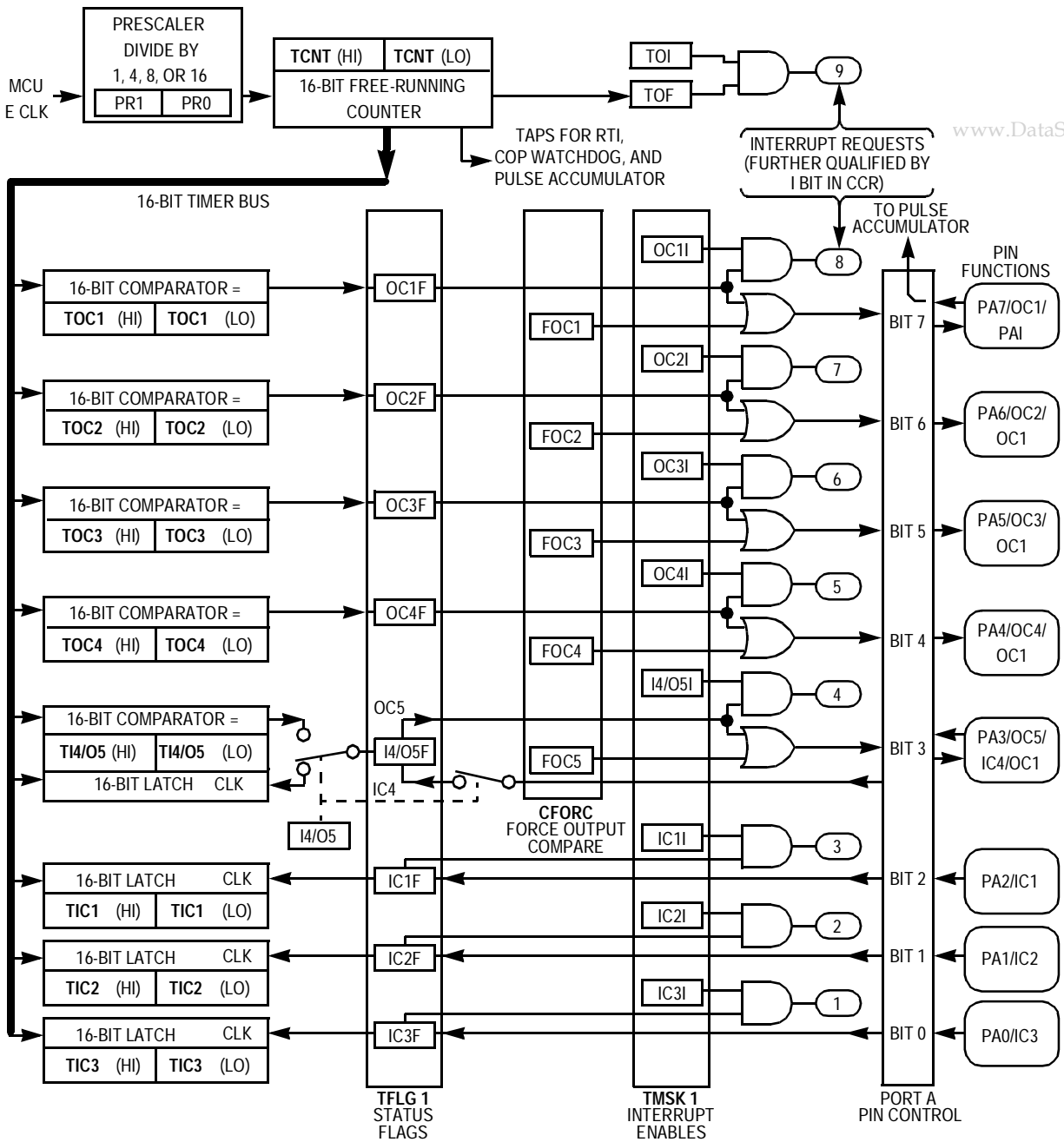

Figure 9-1. Timer Block Diagram

9.3 Timer Registers

This subsection provides a description of the registers associated with the timer system.

www.DataSheet4U.com

9.3.1 Timer Compare Force Register

Address: \$000B

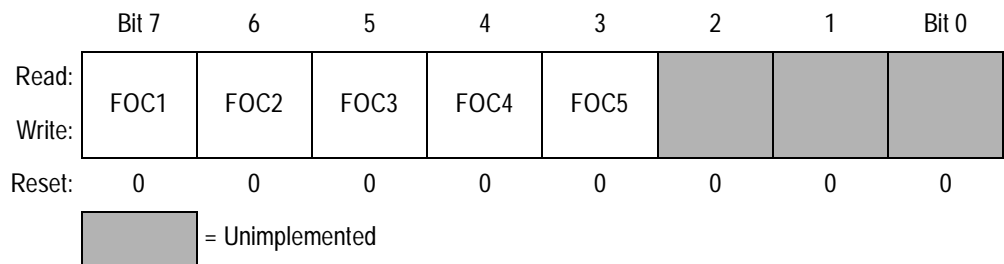

Figure 9-2. Timer Compare Force Register (CFORC)

FOC[5:1] — Force Output Compare Bits

Write 1s to force compare(s)

0 = Not affected

1 = Output x action occurs

Bits [2:0] — Unimplemented

Always read 0

9.3.2 Output Compare 1 Mask Register

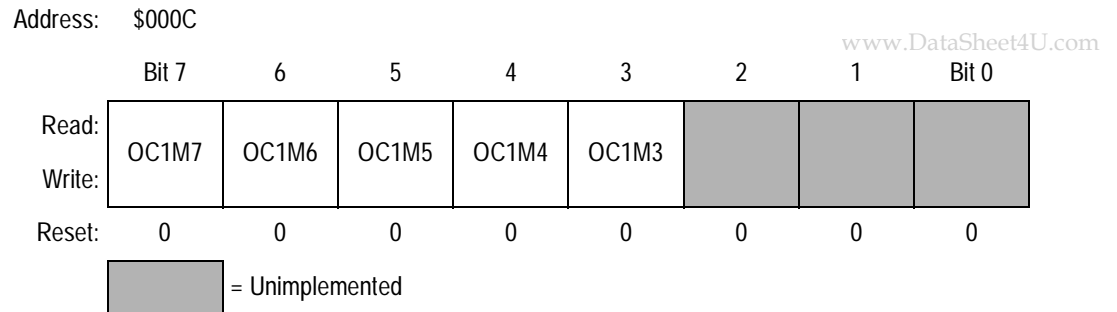

Figure 9-3. Output Compare 1 Mask Register (OC1M)

OC1M[7:3] — Output Compare 1 Mask Bits

Set bit(s) to enable OC1 to control corresponding pin(s) of port A

Bits [2:0] — Unimplemented

Always read as 0

9.3.3 Output Compare 1 Data Register

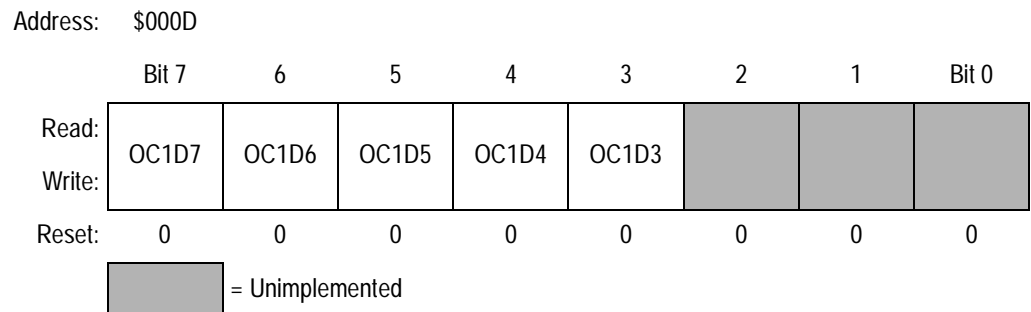

Figure 9-4. Output Compare 1 Data Register (OC1D)

OC1D[7:3] — Output Compare 1 Data Bits

If OC1Mx is set, data in OC1Dx is output to port A bit x on successful OC1 compares.

Bits [2:0] — Unimplemented

Always read 0

9.3.4 Timer Count Register

Address: \$000E — High

www.DataSheet4U.com

	Bit 7	6	5	4	3	2	1	Bit 0
Read:	Bit 15	Bit 14	Bit 13	Bit 12	Bit 11	Bit 10	Bit 9	Bit 8
Write:								
Reset:	0	0	0	0	0	0	0	0

Address: \$000F — Low

	Bit 7	Bit 6	Bit 5	Bit 4	Bit 3	Bit 2	Bit 1	Bit 0
Read:								
Write:								
Reset:	0	0	0	0	0	0	0	0

 = Unimplemented

Figure 9-5. Timer Count Register (TCNT)

The timer count register (TCNT) is read only in normal modes.

9.3.5 Timer Input Capture Registers

Address: \$0010 — High

www.DataSheet4U.com

	Bit 7	6	5	4	3	2	1	Bit 0
Read:	Bit 15	Bit 14	Bit 13	Bit 12	Bit 11	Bit 10	Bit 9	Bit 8
Write:	Bit 15	Bit 14	Bit 13	Bit 12	Bit 11	Bit 10	Bit 9	Bit 8

Reset: Unaffected by reset

Address: \$0011 — Low

Read:	Bit 7	Bit 6	Bit 5	Bit 4	Bit 3	Bit 2	Bit 1	Bit 0
Write:	Bit 7	Bit 6	Bit 5	Bit 4	Bit 3	Bit 2	Bit 1	Bit 0

Reset: Unaffected by reset

Figure 9-6. Timer Input Capture Register 1 (TIC1)

Address: \$0012 — High

	Bit 7	6	5	4	3	2	1	Bit 0
Read:	Bit 15	Bit 14	Bit 13	Bit 12	Bit 11	Bit 10	Bit 9	Bit 8
Write:	Bit 15	Bit 14	Bit 13	Bit 12	Bit 11	Bit 10	Bit 9	Bit 8

Reset: Unaffected by reset

Address: \$0013 — Low

Read:	Bit 7	Bit 6	Bit 5	Bit 4	Bit 3	Bit 2	Bit 1	Bit 0
Write:	Bit 7	Bit 6	Bit 5	Bit 4	Bit 3	Bit 2	Bit 1	Bit 0

Reset: Unaffected by reset

Figure 9-7. Timer Input Capture Register 2 (TIC2)

Address: \$0014 — High

	Bit 7	6	5	4	3	2	1	Bit 0
Read:	Bit 15	Bit 14	Bit 13	Bit 12	Bit 11	Bit 10	Bit 9	Bit 8
Write:	Bit 15	Bit 14	Bit 13	Bit 12	Bit 11	Bit 10	Bit 9	Bit 8

Reset: Unaffected by reset

Address: \$0015 — Low

Read:	Bit 7	Bit 6	Bit 5	Bit 4	Bit 3	Bit 2	Bit 1	Bit 0
Write:	Bit 7	Bit 6	Bit 5	Bit 4	Bit 3	Bit 2	Bit 1	Bit 0

Reset: Unaffected by reset

Figure 9-8. Timer Input Capture Register 3 (TIC3)

9.3.6 Timer Output Compare Registers

Address: \$0016 — High

	Bit 7	6	5	4	3	2	1	Bit 0
Read:	Bit 15	Bit 14	Bit 13	Bit 12	Bit 11	Bit 10	Bit 9	Bit 8
Write:								
Reset:	1	1	1	1	1	1	1	1

www.DataSheet4U.com

Address: \$0017 — Low

Read:	Bit 7	Bit 6	Bit 5	Bit 4	Bit 3	Bit 2	Bit 1	Bit 0
Write:								
Reset:	1	1	1	1	1	1	1	1

Figure 9-9. Timer Output Compare Register 1 (TOC1)

Address: \$0018 — High

	Bit 7	6	5	4	3	2	1	Bit 0
Read:	Bit 15	Bit 14	Bit 13	Bit 12	Bit 11	Bit 10	Bit 9	Bit 8
Write:								
Reset:	1	1	1	1	1	1	1	1

Address: \$0019 — Low

Read:	Bit 7	Bit 6	Bit 5	Bit 4	Bit 3	Bit 2	Bit 1	Bit 0
Write:								
Reset:	1	1	1	1	1	1	1	1

Figure 9-10. Timer Output Compare Register 2 (TOC2)

Address: \$001A — High

	Bit 7	6	5	4	3	2	1	Bit 0
Read:	Bit 15	Bit 14	Bit 13	Bit 12	Bit 11	Bit 10	Bit 9	Bit 8
Write:								
Reset:	1	1	1	1	1	1	1	1

Address: \$001B — Low

Read:	Bit 7	Bit 6	Bit 5	Bit 4	Bit 3	Bit 2	Bit 1	Bit 0
Write:								
Reset:	1	1	1	1	1	1	1	1

Figure 9-11. Timer Output Compare Register 3 (TOC3)

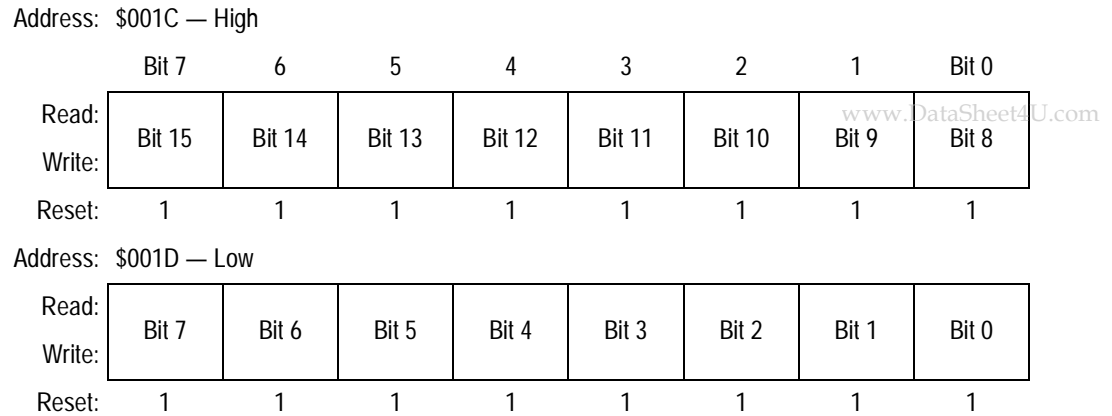

Figure 9-12. Timer Output Compare Register 4 (TOC4)

9.3.7 Timer Input Capture 4/Output Compare 5 Register

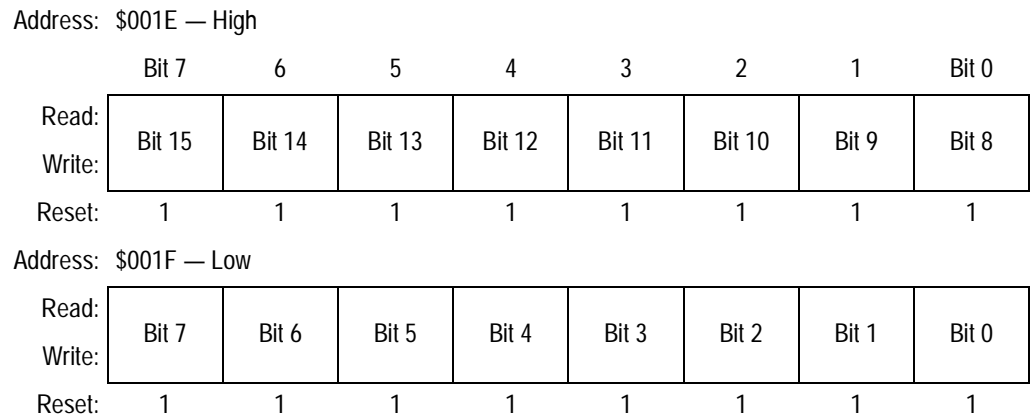

Figure 9-13. Timer Input Capture4/Output Compare 5 Register (TI4/O5)

This is a shared register and is either input capture 4 or output compare 5 depending on the state of bit I4/O5 in PACTL. Writes to TI4/O5 have no effect when this register is configured as input capture 4.

9.3.8 Timer Control Register 1

Address: \$0020

www.DataSheet4U.com

	Bit 7	6	5	4	3	2	1	Bit 0
Read:	OM2	OL2	OM3	OL3	OM4	OL4	OM5	OL5
Write:								
Reset:	0	0	0	0	0	0	0	0

Figure 9-14. Timer Control Register 1 (TCTL1)

OM[5:2] — Output Mode

OL[5:2] — Output Level

See [Table 9-2](#).

Table 9-2. Timer Output Compare Actions

OMx	OLx	Action Taken on Successful Compare
0	0	Timer disconnected from output pin logic
0	1	Toggle OCx output line
1	0	Clear OCx output line to 0
1	1	Set OCx output line to 1

9.3.9 Timer Control Register 2

Address: \$0021

www.DataSheet4U.com

	Bit 7	6	5	4	3	2	1	Bit 0
Read:	EDG4B	EDG4A	EDG1B	EDG1A	EDG2B	EDG2A	EDG3B	EDG3A
Write:								
Reset:	0	0	0	0	0	0	0	0

Figure 9-15. Timer Control Register 2 (TCTL2)

Table 9-3. Timer Control Configuration

EDGxB	EDGxA	Configuration
0	0	Capture disabled
0	1	Capture on rising edges only
1	0	Capture on falling edges only
1	1	Capture on any edge

9.3.10 Timer Interrupt Mask 1 Register

Address: \$0022

www.DataSheet4U.com

	Bit 7	6	5	4	3	2	1	Bit 0
Read:	OC1I	OC2I	OC3I	OC4I	I4/O5I	IC1I	IC2I	IC3I
Write:								
Reset:	0	0	0	0	0	0	0	0

Figure 9-16. Timer Interrupt Mask 1 Register (TMSK1)

OC1I–OC4I — Output Compare Interrupt Enable Bits

If the OCxF flag bit is set while the OCxI enable bit is set, a hardware interrupt sequence is requested.

I4/OC5I — Input Capture 4 or Output Compare 5 Interrupt Enable Bit

When I4/O5 in PACTL is 1, I4/O5I is the input capture 4 interrupt bit. When I4/O5 in PACTL is 0, I4/O5I is the output compare 5 interrupt control bit.

IC1I–IC3I — Input Capture Interrupt Enable Bits

If the ICxF flag bit is set while the ICxI enable bit is set, a hardware interrupt sequence is requested.

NOTE: Control bits in TMSK1 correspond bit for bit with flag bits in TFLG1. Ones in TMSK1 enable the corresponding interrupt sources.

9.3.11 Timer Interrupt Flag 1 Register

Address: \$0023

	Bit 7	6	5	4	3	2	1	Bit 0
Read:	OC1F	OC2F	OC3F	OC4F	I4/O5F	IC1F	IC2F	IC3F
Write:								
Reset:	0	0	0	0	0	0	0	0

Figure 9-17. Timer Interrupt Flag 1 Register (TFLG1)

Clear flags by writing a 1 to the corresponding bit position(s).

OC1F–OC4F — Output Compare x Flags

Set each time the counter matches output compare x value

I4/O5F — Input Capture 4/Output Compare 5 Flag

Set by IC4 or OC5, depending on which function was enabled by I4/O5 of PACTL

IC1F–IC3F — Input Capture x Flag

Set each time a selected active edge is detected on the ICx input line

9.3.12 Timer Interrupt Mask 2 Register

Address: \$0024

	Bit 7	6	5	4	3	2	1	Bit 0
Read:	TOI	RTII	PAOVI	PAII			PR1	PR0
Write:								
Reset:	0	0	0	0	0	0	0	0

 = Unimplemented

Figure 9-18. Timer Interrupt Mask 2 Register (TMSK2)

TOI — Timer Overflow Interrupt Enable Bit

0 = Timer overflow interrupt disabled

1 = Timer overflow interrupt enabled

RTII — Real-Time Interrupt Enable Bit
 0 = RTIF interrupts disabled
 1 = Interrupt requested when RTIF is set to 1

PAOVI — Pulse Accumulator Overflow Interrupt Enable Bit www.DataSheet4U.com
 Refer to **9.4 Pulse Accumulator**.

PAII — Pulse Accumulator Interrupt Enable Bit
 Refer to **9.4 Pulse Accumulator**.

Bits [3:2] — Unimplemented
 Always read as 0

PR[1:0] — Timer Prescaler Select Bits
 In normal modes, PR1 and PR0 can be written only once, and the writes must occur within 64 cycles after reset. Refer to **Table 9-1** and **Table 9-4** for specific timing values.

Table 9-4. Timer Prescale

PR[1:0]	Prescaler
0 0	÷ 1
0 1	÷ 4
1 0	÷ 8
1 1	÷ 16

NOTE: Control bits [7:4] in TMSK2 correspond bit for bit with flag bits [7:4] in TFLG2. Logic 1s in TMSK2 enable the corresponding interrupt sources.

9.3.13 Timer Interrupt Flag Register 2

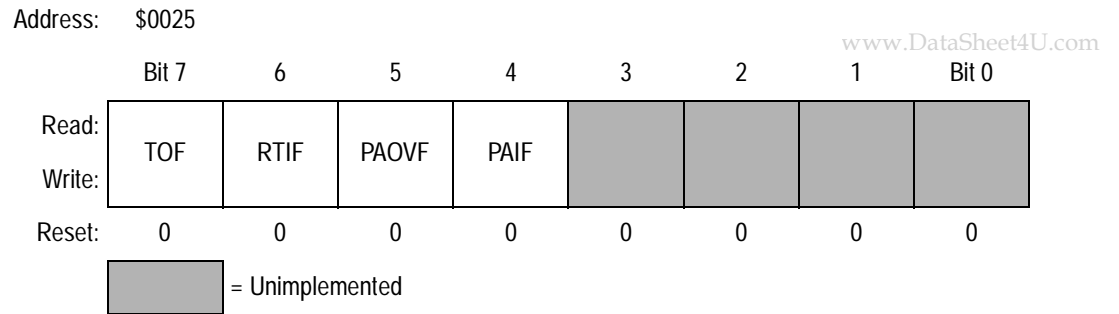

Figure 9-19. Timer Interrupt Flag 2 Register (TFLG2)

Clear flags by writing a 1 to the corresponding bit position(s).

TOF — Timer Overflow Interrupt Flag

Set when TCNT changes from \$FFFF to \$0000

RTIF — Real-Time (Periodic) Interrupt Flag

Set periodically. Refer to the description of bits RTR[1:0] in [Figure 9-21](#).

PAOVF — Pulse Accumulator Overflow Flag

Refer to [9.4 Pulse Accumulator](#).

PAIF — Pulse Accumulator Input Edge Flag

Refer to [9.4 Pulse Accumulator](#).

Bits [3:0] — Unimplemented

Always read 0

9.4 Pulse Accumulator

The MC68HC11ED0 has an 8-bit counter that can be configured as a simple event counter or for gated time accumulation. The counter can be read or written at any time.

The port A bit 7 I/O pin can be configured to act as a clock in event counting mode, or as a gate signal to enable a free-running clock (E divided by 64) to the 8-bit counter in gated time accumulation mode.

Refer to [Figure 9-1](#) and [Table 9-5](#).

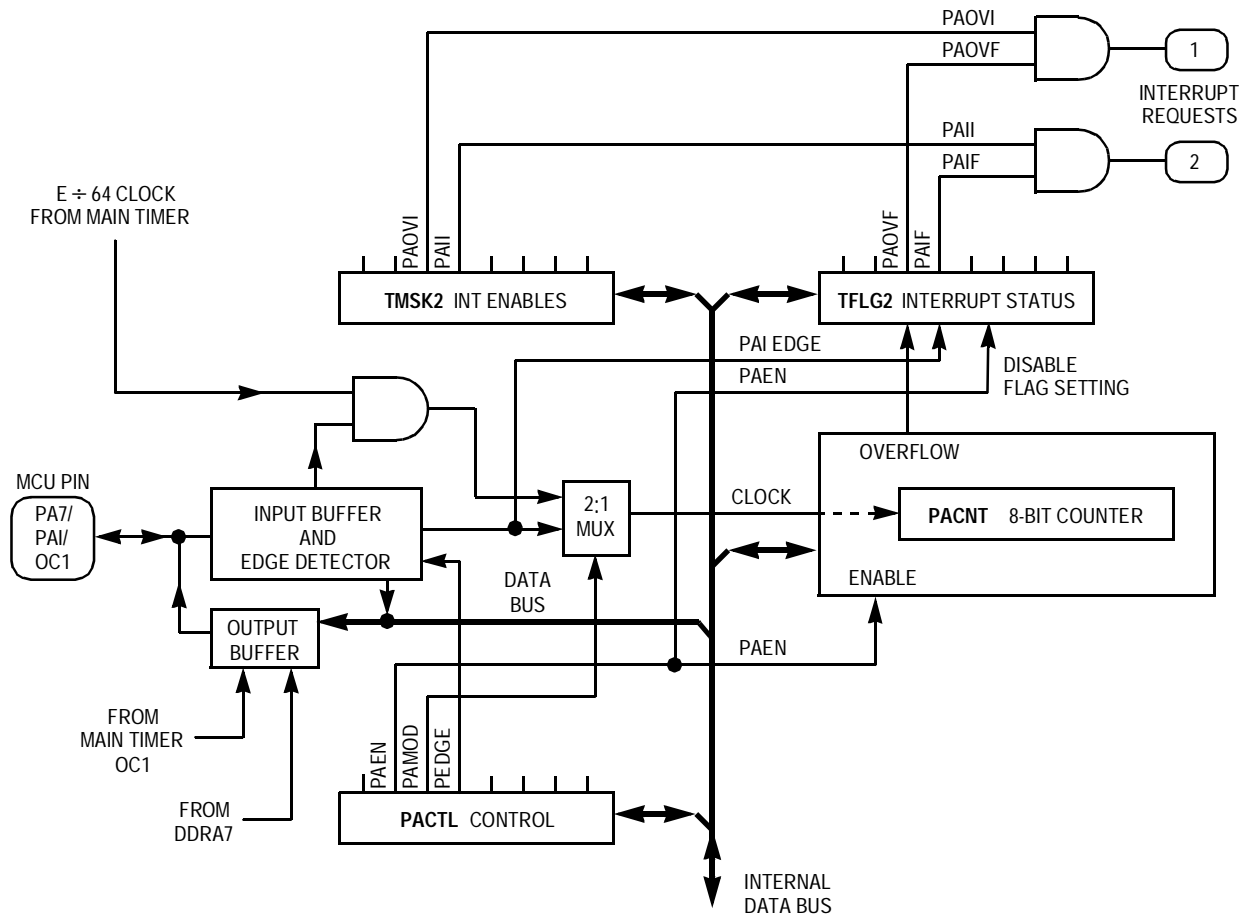

Figure 9-20. Pulse Accumulator System Block Diagram

Table 9-5. Pulse Accumulator Timing

		Common XTAL Frequencies		
		4.0 MHz	8.0 MHz	12.0 MHz
CPU Clock	(E)	1.0 MHz	2.0 MHz	3.0 MHz
Cycle Time	(1 ÷ E)	1000 ns	500 ns	333 ns
Pulse Accumulator (Gated Mode)				
1 Count	(2 ⁶ ÷ E)	64.0 μs	32.0 μs	21.330 μs
Overflow	2 ¹⁴ ÷ E)	16.384 ms	8.192 ms	5.491 ms

Pulse accumulator control bits are also located within two timer registers, TMSK2 and TFLG2, as described in [9.4.1 Pulse Accumulator Control Register](#).

9.4.1 Pulse Accumulator Control Register

Address: \$0026

	Bit 7	6	5	4	3	2	1	Bit 0
Read:	DDRA7	PAEN	PAMOD	PEDGE	DDRA3	I4/O5	RTR1	RTR0
Write:								
Reset:	0	0	0	0	0	0	0	0

Figure 9-21. Pulse Accumulator Control Register (PACTL)

DDRA7 — Data Direction for Port A Bit 7

Refer to [Section 6. Parallel Input/Output \(I/O\) Ports](#).

PAEN — Pulse Accumulator System Enable Bit

0 = Pulse accumulator disabled

1 = Pulse accumulator enabled

PAMOD — Pulse Accumulator Mode Bit

0 = Event counter

1 = Gated time accumulation

PEDGE — Pulse Accumulator Edge Control Bit

0 = In event mode, falling edges increment counter. In gated accumulation mode, high level enables accumulator and falling edge sets PAIF.

1 = In event mode, rising edges increment counter. In gated accumulation mode, low level enables accumulator and rising edge sets PAIF.

www.DataSheet4U.com

DDRA3 — Data Direction for Port A Bit 3

Refer to [Section 6. Parallel Input/Output \(I/O\) Ports](#).

I4/O5 — Input Capture 4/Output Compare Bit

Configure TI4/O5 for input capture or output compare

0 = OC5 enabled

1 = IC4 enabled

RTR[1:0] — RTI Interrupt Rate Select Bits

These two bits select the rate for periodic interrupts. Refer to [Table 9-6](#) and [Table 9-7](#).

Table 9-6. RTI Rates (Period Length)

RTR[1:0]	Period Length Selected	Period Length		
		E = 1.0 MHz	E = 2.0 MHz	E = 3.0 MHz
0 0	$2^{13} \div E$	8.19 ms	4.096 ms	2.731 ms
0 1	$2^{14} \div E$	16.38 ms	8.192 ms	5.461 ms
1 0	$2^{15} \div E$	32.77 ms	16.384 ms	10.923 ms
1 1	$2^{16} \div E$	65.54 ms	32.768 ms	21.845 ms

Table 9-7. RTI Rates (Frequency)

RTR[1:0]	Rate Selected	Frequency		
		E = 1.0 MHz	E = 2.0 MHz	E = 3.0 MHz
0 0	$E \div 2^{13}$	122.070 Hz	244.141 Hz	366.211 Hz
0 1	$E \div 2^{14}$	61.035 Hz	122.070 Hz	183.105 Hz
1 0	$E \div 2^{15}$	30.518 Hz	61.035 Hz	91.553 Hz
1 1	$E \div 2^{16}$	15.259 Hz	30.518 Hz	45.776 Hz

9.4.2 Pulse Accumulator Counter Register

Refer to [Figure 9-22](#) for a description of the pulse accumulator counter register (PACNT).

www.DataSheet4U.com

Address: \$0027

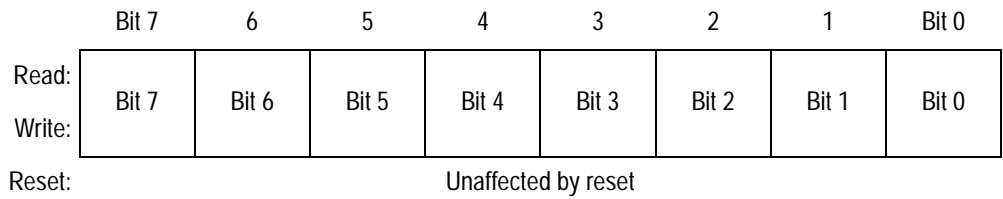

Figure 9-22. Pulse Accumulator Counter Register (PACNT)

Freescale Semiconductor, Inc.

Home Page:

www.freescale.com

email:

support@freescale.com

USA/Europe or Locations Not Listed:

Freescale Semiconductor
Technical Information Center, CH370
1300 N. Alma School Road
Chandler, Arizona 85224
(800) 521-6274
480-768-2130

support@freescale.com

Europe, Middle East, and Africa:

Freescale Halbleiter Deutschland GmbH
Technical Information Center
Schatzbogen 7
81829 Muenchen, Germany
+44 1296 380 456 (English)
+46 8 52200080 (English)
+49 89 92103 559 (German)
+33 1 69 35 48 48 (French)
support@freescale.com

Japan:

Freescale Semiconductor Japan Ltd.
Headquarters
ARCO Tower 15F
1-8-1, Shimo-Meguro, Meguro-ku
Tokyo 153-0064, Japan
0120 191014
+81 2666 8080

support.japan@freescale.com

Asia/Pacific:

Freescale Semiconductor Hong Kong Ltd.
Technical Information Center
2 Dai King Street
Tai Po Industrial Estate,
Tai Po, N.T., Hong Kong
+800 2666 8080

support.asia@freescale.com

For Literature Requests Only:

Freescale Semiconductor
Literature Distribution Center
P.O. Box 5405
Denver, Colorado 80217
(800) 441-2447
303-675-2140
Fax: 303-675-2150
LDCForFreescaleSemiconductor@hibbertgroup.com

RoHS-compliant and/or Pb-free versions of Freescale products have the functionality and electrical characteristics of their non-RoHS-compliant and/or non-Pb-free counterparts. For further information, see <http://www.freescale.com> or contact your Freescale sales representative.

For information on Freescale's Environmental Products program, go to <http://www.freescale.com/epp>. www.DataSheet4U.com

Information in this document is provided solely to enable system and software implementers to use Freescale Semiconductor products. There are no express or implied copyright licenses granted hereunder to design or fabricate any integrated circuits or integrated circuits based on the information in this document. Freescale Semiconductor reserves the right to make changes without further notice to any products herein. Freescale Semiconductor makes no warranty, representation or guarantee regarding the suitability of its products for any particular purpose, nor does Freescale Semiconductor assume any liability arising out of the application or use of any product or circuit, and specifically disclaims any and all liability, including without limitation consequential or incidental damages. "Typical" parameters which may be provided in Freescale Semiconductor data sheets and/or specifications can and do vary in different applications and actual performance may vary over time. All operating parameters, including "Typicals" must be validated for each customer application by customer's technical experts. Freescale Semiconductor does not convey any license under its patent rights nor the rights of others. Freescale Semiconductor products are not designed, intended, or authorized for use as components in systems intended for surgical implant into the body, or other applications intended to support or sustain life, or for any other application in which the failure of the Freescale Semiconductor product could create a situation where personal injury or death may occur. Should Buyer purchase or use Freescale Semiconductor products for any such unintended or unauthorized application, Buyer shall indemnify and hold Freescale Semiconductor and its officers, employees, subsidiaries, affiliates, and distributors harmless against all claims, costs, damages, and expenses, and reasonable attorney fees arising out of, directly or indirectly, any claim of personal injury or death associated with such unintended or unauthorized use, even if such claim alleges that Freescale Semiconductor was negligent regarding the design or manufacture of the part.

