

Octal D-Type Latch with 3-State Outputs

The MC74AC564/74ACT564 is a high-speed, low power octal flip-flop with a buffered common Clock (CP) and a buffered common Output Enable (\overline{OE}).

The information presented to the D inputs is stored in the flip-flops on the LOW-to-HIGH Clock (CP) transition.

The MC74AC564/74ACT564 device is functionally identical to the MC74AC574/74ACT574, but with inverted outputs.

- Inputs and Outputs on Opposite Sides of Package Allowing Easy Interface with Microprocessors
- Useful as Input or Output Port for Microprocessors
- Functionally Identical to MC74AC574/74ACT574 but with Inverted Outputs
- 3-State Outputs for Bus-Oriented Applications
- Outputs Source/Sink 24 mA
- 'ACT564 Has TTL Compatible Inputs

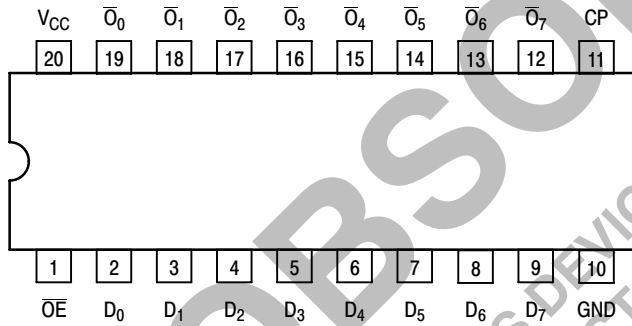

Figure 1. Pinout: 20-Lead Packages Conductors (Top View)

PIN NAMES

- D_0 – D_7 Data Inputs
- CP Clock Pulse Input
- \overline{OE} 3-State Output Enable Input
- \overline{O}_0 – \overline{O}_7 3-State Outputs

**MC74AC564
MC74ACT564**

**OCTAL D-TYPE
LATCH WITH
3-STATE OUTPUTS**

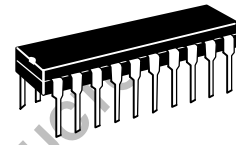

**N SUFFIX
CASE 738-03
PLASTIC**

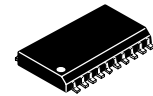

**DW SUFFIX
CASE 751D-04
PLASTIC**

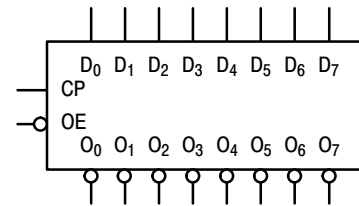

Figure 2. LOGIC SYMBOL

FUNCTIONAL DESCRIPTION

The MC74AC564/74ACT564 consists of eight edge-triggered flip-flops with individual D-type inputs and 3-state complementary outputs. The buffered clock and buffered Output Enable are common to all flip-flops. The eight flip-flops will store the state of their individual D inputs that meet the setup and hold times requirements on

the LOW-to-HIGH Clock (CP) transition. With the Output Enable (\overline{OE}) LOW, the contents of the eight flip-flops are available at the outputs. When \overline{OE} is HIGH, the outputs go to the high impedance state. Operation of the \overline{OE} input does not affect the state of the flip-flops.

FUNCTION TABLE

| Inputs | | | Internal | Outputs | Function |
|-----------------|----|---|----------|---------|-------------------|
| \overline{OE} | CP | D | Q | O | |
| H | H | L | NC | Z | Hold |
| H | H | H | NC | Z | Hold |
| H | ⌋ | L | H | Z | Load |
| H | ⌋ | H | L | Z | Load |
| L | ⌋ | L | H | H | Data Available |
| L | ⌋ | H | L | L | Data Available |
| L | H | L | NC | NC | No Change in Data |
| L | H | H | NC | NC | No Change in Data |

H = HIGH Voltage Level
 L = LOW Voltage Level
 X = Immaterial
 Z = High Impedance
 ⌋ = LOW-to-HIGH Transition
 NC = No Change

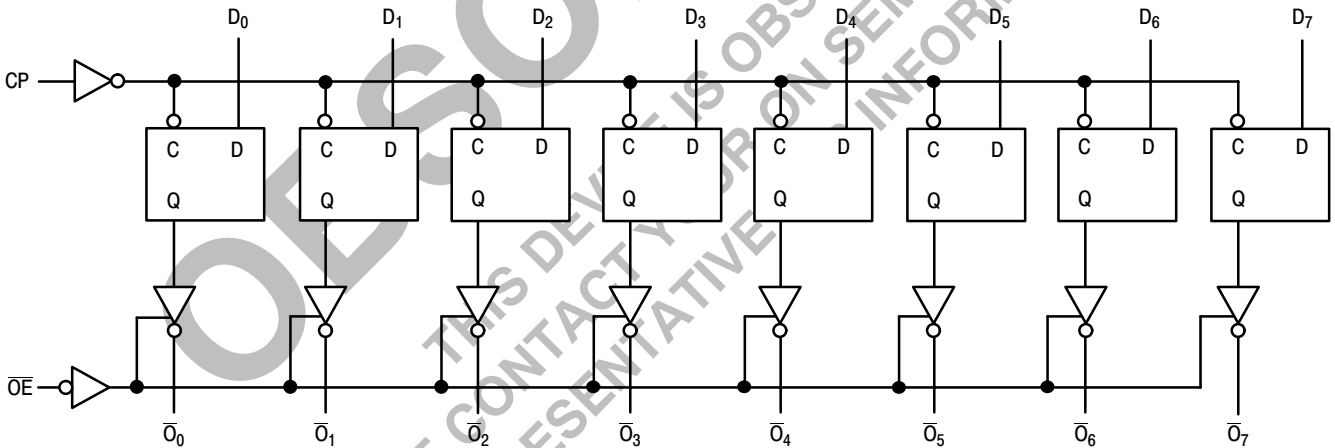

Please note that this diagram is provided only for the understanding of logic operations and should not be used to estimate propagation delays.

Figure 3. Logic Diagram

MC74AC564 MC74ACT564

MAXIMUM RATINGS*

| Symbol | Parameter | Value | Unit |
|-----------|---|------------------------|--------------------|
| V_{CC} | DC Supply Voltage (Referenced to GND) | -0.5 to +7.0 | V |
| V_{in} | DC Input Voltage (Referenced to GND) | -0.5 to $V_{CC} + 0.5$ | V |
| V_{out} | DC Output Voltage (Referenced to GND) | -0.5 to $V_{CC} + 0.5$ | V |
| I_{in} | DC Input Current, per Pin | ± 20 | mA |
| I_{out} | DC Output Sink/Source Current, per Pin | ± 50 | mA |
| I_{CC} | DC V_{CC} or GND Current per Output Pin | ± 50 | mA |
| T_{stg} | Storage Temperature | -65 to +150 | $^{\circ}\text{C}$ |

* Maximum Ratings are those values beyond which damage to the device may occur. Functional operation should be restricted to the Recommended Operating Conditions.

RECOMMENDED OPERATING CONDITIONS

| Symbol | Parameter | Min | Typ | Max | Unit | |
|-------------------|---|-------------------------|-----|----------|--------------------|------|
| V_{CC} | Supply Voltage | 'AC | 2.0 | 5.0 | 6.0 | V |
| | | 'ACT | 4.5 | 5.0 | 5.5 | |
| V_{in}, V_{out} | DC Input Voltage, Output Voltage (Ref. to GND) | 0 | | V_{CC} | V | |
| t_r, t_f | Input Rise and Fall Time (Note 1) 'AC Devices except Schmitt Inputs | $V_{CC} @ 3.0\text{ V}$ | | 150 | | ns/V |
| | | $V_{CC} @ 4.5\text{ V}$ | | 40 | | |
| | | $V_{CC} @ 5.5\text{ V}$ | | 25 | | |
| t_r, t_f | Input Rise and Fall Time (Note 2) 'ACT Devices except Schmitt Inputs | $V_{CC} @ 4.5\text{ V}$ | | 10 | | ns/V |
| | | $V_{CC} @ 5.5\text{ V}$ | | 8.0 | | |
| T_J | Junction Temperature (PDIP) | | | 140 | $^{\circ}\text{C}$ | |
| T_A | Operating Ambient Temperature Range | -40 | 25 | 85 | $^{\circ}\text{C}$ | |
| I_{OH} | Output Current — High | | | -24 | mA | |
| I_{OL} | Output Current — Low | | | 24 | mA | |

- V_{in} from 30% to 70% V_{CC} ; see individual Data Sheets for devices that differ from the typical input rise and fall times.
- V_{in} from 0.8 V to 2.0 V; see individual Data Sheets for devices that differ from the typical input rise and fall times.

MC74AC564 MC74ACT564

DC CHARACTERISTICS

| Symbol | Parameter | V _{CC} (V) | 74AC | | 74AC | Unit | Conditions |
|------------------|--------------------------------------|------------------------|------------------------|-------------------|---------------------------------------|------|---|
| | | | T _A = +25°C | | T _A = -40°C to +85°C | | |
| | | | Typ | Guaranteed Limits | | | |
| V _{IH} | Minimum High Level Input Voltage | 3.0 | 1.5 | 2.1 | 2.1 | V | V _{OUT} = 0.1 V or V _{CC} - 0.1 V |
| | | 4.5 | 2.25 | 3.15 | 3.15 | | |
| | | 5.5 | 2.75 | 3.85 | 3.85 | | |
| V _{IL} | Maximum Low Level Input Voltage | 3.0 | 1.5 | 0.9 | 0.9 | V | V _{OUT} = 0.1 V or V _{CC} - 0.1 V |
| | | 4.5 | 2.25 | 1.35 | 1.35 | | |
| | | 5.5 | 2.75 | 1.65 | 1.65 | | |
| V _{OH} | Minimum High Level Output Voltage | 3.0 | 2.99 | 2.9 | 2.9 | V | I _{OUT} = -50 μA |
| | | 4.5 | 4.49 | 4.4 | 4.4 | | |
| | | 5.5 | 5.49 | 5.4 | 5.4 | | |
| | | 3.0 | | 2.56 | 2.46 | V | *V _{IN} = V _{IL} or V _{IH} -12 mA I _{OH} -24 mA -24 mA |
| | | 4.5 | | 3.86 | 3.76 | | |
| | | 5.5 | | 4.86 | 4.76 | | |
| V _{OL} | Maximum Low Level Output Voltage | 3.0 | 0.002 | 0.1 | 0.1 | V | I _{OUT} = 50 μA |
| | | 4.5 | 0.001 | 0.1 | 0.1 | | |
| | | 5.5 | 0.001 | 0.1 | 0.1 | | |
| | | 3.0 | | 0.36 | 0.44 | V | *V _{IN} = V _{IL} or V _{IH} 12 mA I _{OL} 24 mA 24 mA |
| | | 4.5 | | 0.36 | 0.44 | | |
| | | 5.5 | | 0.36 | 0.44 | | |
| I _{IN} | Maximum Input Leakage Current | 5.5 | | ±0.1 | ±1.0 | μA | V _I = V _{CC} , GND |
| I _{OZ} | Maximum 3-State Current | 5.5 | | ±0.5 | ±5.0 | μA | V _I (OE) = V _{IL} , V _{IH} V _I = V _{CC} , GND V _O = V _{CC} , GND |
| I _{OLD} | †Minimum Dynamic Output Current | 5.5 | | | 75 | mA | V _{OLD} = 1.65 V Max |
| I _{OHD} | | 5.5 | | | -75 | mA | V _{OHD} = 3.85 V Min |
| I _{CC} | Maximum Quiescent Supply Current | 5.5 | | 8.0 | 80 | μA | V _{IN} = V _{CC} or GND |

* All outputs loaded; thresholds on input associated with output under test.

† Maximum test duration 2.0 ms, one output loaded at a time.

Note: I_{IN} and I_{CC} @ 3.0 V are guaranteed to be less than or equal to the respective limit @ 5.5 V V_{CC}.

MC74AC564 MC74ACT564

AC CHARACTERISTICS (For Figures and Waveforms — See Section 3 of the ON Semiconductor FACT Data Book, DL138/D)

| Symbol | Parameter | V _{CC} * (V) | 74AC | | | 74AC | | Unit | Fig. No. |
|------------------|--|--------------------------|--|-----|--------------|--|--------------|------|----------|
| | | | T _A = +25°C C _L = 50 pF | | | T _A = -40°C to +85°C C _L = 50 pF | | | |
| | | | Min | Typ | Max | Min | Max | | |
| f _{max} | Maximum Clock Frequency | 3.3 5.0 | 75 95 | | | 60 85 | | MHz | 3-3 |
| t _{PLH} | Propagation Delay CP to \bar{O}_n | 3.3 5.0 | 3.5 2.0 | | 14.0 10.5 | 3.5 2.0 | 15.5 11.5 | ns | 3-6 |
| t _{PHL} | Propagation Delay CP to \bar{O}_n | 3.3 5.0 | 3.5 2.0 | | 12.5 9.5 | 3.5 2.0 | 14.0 10.5 | ns | 3-6 |
| t _{PZH} | Output Enable Time | 3.3 5.0 | 2.5 2.0 | | 11.5 9.0 | 2.5 2.0 | 12.5 9.5 | ns | 3-7 |
| t _{PZL} | Output Enable Time | 3.3 5.0 | 3.0 1.5 | | 11.0 8.5 | 3.5 2.0 | 12.0 9.5 | ns | 3-8 |
| t _{PHZ} | Output Disable Time | 3.3 5.0 | 4.0 2.0 | | 12.5 10.5 | 4.5 2.0 | 13.5 11.5 | ns | 3-7 |
| t _{PLZ} | Output Disable Time | 3.3 5.0 | 2.0 1.5 | | 9.5 8.0 | 2.5 1.5 | 10.5 9.0 | ns | 3-8 |

* Voltage Range 3.3 V is 3.3 V ±0.3 V.
Voltage Range 5.0 V is 5.0 V ±0.5 V.

AC OPERATING REQUIREMENTS

| Symbol | Parameter | V _{CC} * (V) | 74AC | | 74AC | | Unit | Fig. No. |
|----------------|---|--------------------------|--|--------------------|--|------------|------|----------|
| | | | T _A = +25°C C _L = 50 pF | | T _A = -40°C to +85°C C _L = 50 pF | | | |
| | | | Typ | Guaranteed Minimum | | | | |
| t _s | Setup Time, HIGH or LOW D _n to CP | 3.3 5.0 | | 2.5 2.0 | | 3.0 2.5 | ns | 3-9 |
| t _h | Hold Time, HIGH or LOW D _n to CP | 3.3 5.0 | | 2.0 2.0 | | 2.0 2.0 | ns | 3-9 |
| t _w | CP Pulse Width HIGH or LOW | 3.3 5.0 | | 6.0 4.0 | | 7.0 5.0 | ns | 3-6 |

* Voltage Range 3.3 V is 3.3 V ±0.3 V.
Voltage Range 5.0 V is 5.0 V ±0.5 V.

MC74AC564 MC74ACT564

DC CHARACTERISTICS

| Symbol | Parameter | V _{CC} (V) | 74ACT | | 74ACT | | Unit | Conditions |
|------------------|--|------------------------|------------------------|-------------------|---------------------------------|--|------|---|
| | | | T _A = +25°C | | T _A = -40°C to +85°C | | | |
| | | | Typ | Guaranteed Limits | | | | |
| V _{IH} | Minimum High Level Input Voltage | 4.5 | 1.5 | 2.0 | 2.0 | | V | V _{OUT} = 0.1 V or V _{CC} - 0.1 V |
| | | 5.5 | 1.5 | 2.0 | 2.0 | | | |
| V _{IL} | Maximum Low Level Input Voltage | 4.5 | 1.5 | 0.8 | 0.8 | | V | V _{OUT} = 0.1 V or V _{CC} - 0.1 V |
| | | 5.5 | 1.5 | 0.8 | 0.8 | | | |
| V _{OH} | Minimum High Level Output Voltage | 4.5 | 4.49 | 4.4 | 4.4 | | V | I _{OUT} = -50 μA |
| | | 5.5 | 5.49 | 5.4 | 5.4 | | | |
| | | 4.5 | | 3.86 | 3.76 | | V | *V _{IN} = V _{IL} or V _{IH} I _{OH} = -24 mA |
| | | 5.5 | | 4.86 | 4.76 | | | |
| V _{OL} | Maximum Low Level Output Voltage | 4.5 | 0.001 | 0.1 | 0.1 | | V | I _{OUT} = 50 μA |
| | | 5.5 | 0.001 | 0.1 | 0.1 | | | |
| | | 4.5 | | 0.36 | 0.44 | | V | *V _{IN} = V _{IL} or V _{IH} I _{OL} = 24 mA |
| | | 5.5 | | 0.36 | 0.44 | | | |
| I _{IN} | Maximum Input Leakage Current | 5.5 | | ±0.1 | ±1.0 | | μA | V _I = V _{CC} , GND |
| ΔI _{CC} | Additional Max. I _{CC} /Input | 5.5 | 0.6 | | 1.5 | | mA | V _I = V _{CC} - 2.1 V |
| I _{OZ} | Maximum 3-State Current | 5.5 | | ±0.5 | ±5.0 | | μA | V _I (OE) = V _{IL} , V _{IH} V _I = V _{CC} , GND V _O = V _{CC} , GND |
| I _{OLD} | †Minimum Dynamic Output Current | 5.5 | | | 75 | | mA | V _{OLD} = 1.65 V Max |
| I _{OHD} | | 5.5 | | | -75 | | mA | V _{OHD} = 3.85 V Min |
| I _{CC} | Maximum Quiescent Supply Current | 5.5 | | 8.0 | 80 | | μA | V _{IN} = V _{CC} or GND |

* All outputs loaded; thresholds on input associated with output under test.

† Maximum test duration 2.0 ms, one output loaded at a time.

AC CHARACTERISTICS (For Figures and Waveforms — See Section 3 of the ON Semiconductor FACT Data Book, DL138/D)

| Symbol | Parameter | V _{CC} * (V) | 74ACT | | | 74ACT | | Unit | Fig. No. |
|------------------|--|--------------------------|--|-----|------|---|------|------|----------|
| | | | T _A = +25°C C _L = 50 pF | | | T _A = -40°C to +85°C C _L = 50 pF | | | |
| | | | Min | Typ | Max | Min | Max | | |
| f _{max} | Maximum Clock Frequency | 5.0 | 85 | | | 75 | | MHz | 3-3 |
| t _{PLH} | Propagation Delay CP to O _n | 5.0 | 2.0 | | 10.5 | 1.5 | 11.5 | ns | 3-6 |
| t _{PHL} | Propagation Delay CP to O _n | 5.0 | 1.5 | | 9.5 | 1.5 | 10.5 | ns | 3-6 |
| t _{PZH} | Output Enable Time | 5.0 | 1.5 | | 9.0 | 1.5 | 9.5 | ns | 3-7 |
| t _{PZL} | Output Enable Time | 5.0 | 1.5 | | 8.5 | 1.0 | 9.5 | ns | 3-8 |
| t _{PHZ} | Output Disable Time | 5.0 | 1.5 | | 10.5 | 1.5 | 11.5 | ns | 3-7 |
| t _{PLZ} | Output Disable Time | 5.0 | 1.5 | | 8.0 | 1.0 | 8.5 | ns | 3-8 |

* Voltage Range 5.0 V is 5.0 V ±0.5 V.

MC74AC564 MC74ACT564

AC OPERATING REQUIREMENTS

| Symbol | Parameter | V _{CC} * (V) | 74ACT | | Unit | Fig. No. | |
|----------------|---|--------------------------|-------|--------------------|------|----------|-----|
| | | | 74ACT | | | | |
| | | | Typ | Guaranteed Minimum | | | |
| t _s | Setup Time, HIGH or LOW D _n to CP | 5.0 | | 2.5 | 3.0 | ns | 3-9 |
| t _h | Hold Time, HIGH or LOW D _n to CP | 5.0 | | 1.0 | 1.0 | ns | 3-9 |
| t _w | LE Pulse Width HIGH or LOW | 5.0 | | 3.0 | 3.5 | ns | 3-6 |

* Voltage Range 3.3 V is 3.3 V ±0.3 V.

* Voltage Range 5.0 V is 5.0 V ±0.5 V.

CAPACITANCE

| Symbol | Parameter | Value Typ | Unit | Test Conditions |
|-----------------|-------------------------------|--------------|------|-------------------------|
| C _{IN} | Input Capacitance | 4.5 | pF | V _{CC} = 5.0 V |
| C _{PD} | Power Dissipation Capacitance | 50 | pF | V _{CC} = 5.0 V |

OBSOLETE

THIS DEVICE IS OBSOLETE
PLEASE CONTACT YOUR ON SEMICONDUCTOR
REPRESENTATIVE FOR INFORMATION

MC74AC564 MC74ACT564

OUTLINE DIMENSIONS

N SUFFIX
 PLASTIC DIP PACKAGE
 CASE 738-03
 ISSUE E

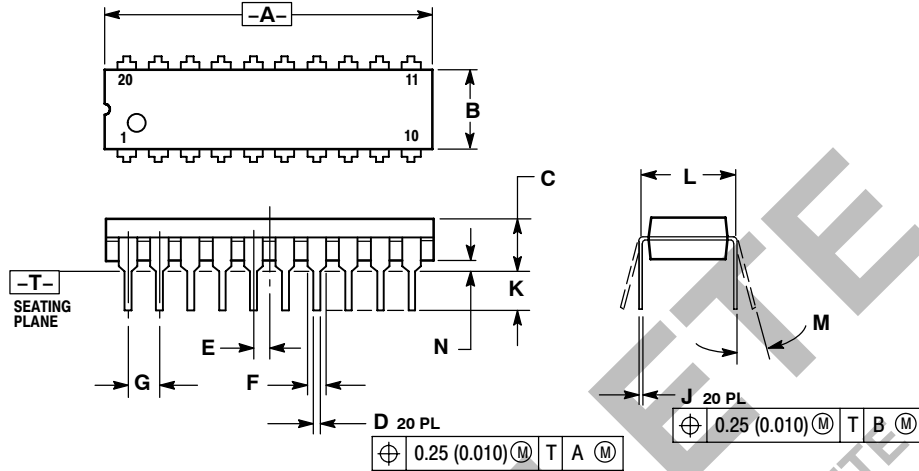

- NOTES:
1. DIMENSIONING AND TOLERANCING PER ANSI Y14.5M, 1982.
 2. CONTROLLING DIMENSION: INCH.
 3. DIMENSION L TO CENTER OF LEAD WHEN FORMED PARALLEL.
 4. DIMENSION B DOES NOT INCLUDE MOLD FLASH.

| DIM | INCHES | | MILLIMETERS | |
|-----|-----------|-------|-------------|-------|
| | MIN | MAX | MIN | MAX |
| A | 1.010 | 1.070 | 25.66 | 27.17 |
| B | 0.240 | 0.260 | 6.10 | 6.60 |
| C | 0.150 | 0.180 | 3.81 | 4.57 |
| D | 0.015 | 0.022 | 0.39 | 0.55 |
| E | 0.050 BSC | | 1.27 BSC | |
| F | 0.050 | 0.070 | 1.27 | 1.77 |
| G | 0.100 BSC | | 2.54 BSC | |
| J | 0.008 | 0.015 | 0.21 | 0.38 |
| K | 0.110 | 0.140 | 2.80 | 3.55 |
| L | 0.300 BSC | | 7.62 BSC | |
| M | 0° | 15° | 0° | 15° |
| N | 0.020 | 0.040 | 0.51 | 1.01 |

OBSOLETE

THIS DEVICE IS OBSOLETE
 PLEASE CONTACT YOUR ON SEMICONDUCTOR
 REPRESENTATIVE FOR INFORMATION

MC74AC564 MC74ACT564

OUTLINE DIMENSIONS

DW SUFFIX
PLASTIC SOIC PACKAGE
CASE 751D-04
ISSUE E

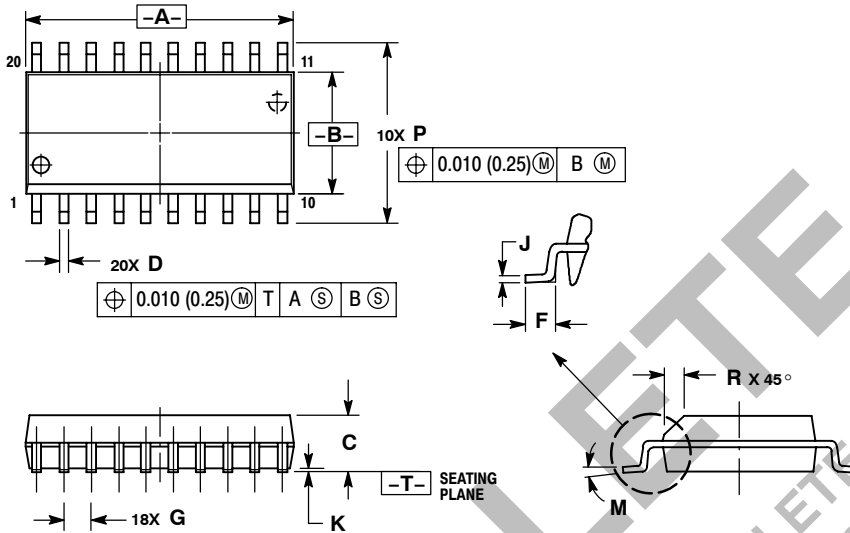

NOTES:

1. DIMENSIONING AND TOLERANCING PER ANSI Y14.5M, 1982.
2. CONTROLLING DIMENSION: MILLIMETER.
3. DIMENSIONS A AND B DO NOT INCLUDE MOLD PROTRUSION.
4. MAXIMUM MOLD PROTRUSION 0.150 (0.006) PER SIDE.
5. DIMENSION D DOES NOT INCLUDE DAMBAR PROTRUSION. ALLOWABLE DAMBAR PROTRUSION SHALL BE 0.13 (0.005) TOTAL IN EXCESS OF D DIMENSION AT MAXIMUM MATERIAL CONDITION.

| DIM | MILLIMETERS | | INCHES | |
|-----|-------------|-------|-----------|-------|
| | MIN | MAX | MIN | MAX |
| A | 12.65 | 12.95 | 0.499 | 0.510 |
| B | 7.40 | 7.60 | 0.292 | 0.299 |
| C | 2.35 | 2.65 | 0.093 | 0.104 |
| D | 0.35 | 0.49 | 0.014 | 0.019 |
| F | 0.50 | 0.90 | 0.020 | 0.035 |
| G | 1.27 BSC | | 0.050 BSC | |
| J | 0.25 | 0.32 | 0.010 | 0.012 |
| K | 0.10 | 0.25 | 0.004 | 0.009 |
| M | 0° | 7° | 0° | 7° |
| P | 10.05 | 10.55 | 0.395 | 0.415 |
| R | 0.25 | 0.75 | 0.010 | 0.029 |

ON Semiconductor and are registered trademarks of Semiconductor Components Industries, LLC (SCILLC). SCILLC reserves the right to make changes without further notice to any products herein. SCILLC makes no warranty, representation or guarantee regarding the suitability of its products for any particular purpose, nor does SCILLC assume any liability arising out of the application or use of any product or circuit, and specifically disclaims any and all liability, including without limitation special, consequential or incidental damages. "Typical" parameters which may be provided in SCILLC data sheets and/or specifications can and do vary in different applications and actual performance may vary over time. All operating parameters, including "Typicals" must be validated for each customer application by customer's technical experts. SCILLC does not convey any license under its patent rights nor the rights of others. SCILLC products are not designed, intended, or authorized for use as components in systems intended for surgical implant into the body, or other applications intended to support or sustain life, or for any other application in which the failure of the SCILLC product could create a situation where personal injury or death may occur. Should Buyer purchase or use SCILLC products for any such unintended or unauthorized application, Buyer shall indemnify and hold SCILLC and its officers, employees, subsidiaries, affiliates, and distributors harmless against all claims, costs, damages, and expenses, and reasonable attorney fees arising out of, directly or indirectly, any claim of personal injury or death associated with such unintended or unauthorized use, even if such claim alleges that SCILLC was negligent regarding the design or manufacture of the part. SCILLC is an Equal Opportunity/Affirmative Action Employer. This literature is subject to all applicable copyright laws and is not for resale in any manner.

PUBLICATION ORDERING INFORMATION

LITERATURE FULFILLMENT:
Literature Distribution Center for ON Semiconductor
P.O. Box 5163, Denver, Colorado 80217 USA
Phone: 303-675-2175 or 800-344-3860 Toll Free USA/Canada
Fax: 303-675-2176 or 800-344-3867 Toll Free USA/Canada
Email: orderlit@onsemi.com

N. American Technical Support: 800-282-9855 Toll Free
USA/Canada
Europe, Middle East and Africa Technical Support:
Phone: 421 33 790 2910
Japan Customer Focus Center
Phone: 81-3-5773-3850

ON Semiconductor Website: www.onsemi.com
Order Literature: <http://www.onsemi.com/orderlit>

For additional information, please contact your local Sales Representative