

Product Preview

Unbuffered Inverter

The MC74HC1GU04 is a high speed CMOS unbuffered inverter fabricated with silicon gate CMOS technology. It achieves high speed operation similar to equivalent LSTTL while maintaining CMOS low power dissipation.

The internal circuit is composed of three stages, including a buffer output which provides high noise immunity and stable output.

The MC74HC1GU04 output drive current is 1/2 compared to MC74HC series.

- High Speed: $t_{pD} = 7\text{ns}$ (Typ) at $V_{CC} = 5\text{V}$
- Low Power Dissipation: $I_{CC} = 1\mu\text{A}$ (Max) at $T_A = 25^\circ\text{C}$
- High Noise Immunity
- Balanced Propagation Delays ($t_{pLH} = t_{pHL}$)
- Output Drive Capability: 5 LSTTL
- Symmetrical Output Impedance ($I_{OH} = I_{OL} = 2\text{mA}$)
- ESD Performance: HBM > 2000V; MM > 200V

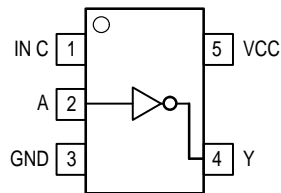

Figure 1. Pinout (Top View)

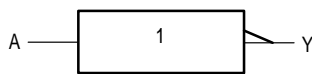
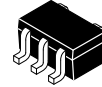

Figure 2. Logic Symbol

MC74HC1GU04



DF SUFFIX
5-LEAD SOT-353 PACKAGE
SC-88A
CASE 419A-01



DT SUFFIX
5-LEAD TSSOP PACKAGE
TSOP5
CASE TBD

FUNCTION TABLE

Inputs	Outputs
L	H
H	L

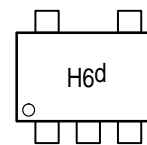

Pin 1
d = Date Code

Marking Diagram

DEVICE ORDERING INFORMATION

Device Order Number	Device Nomenclature						Package Type	Tape and Reel Size
	Motorola Circuit Indicator	Temp Range Identifier	Technology	Device Function	Package Suffix	Tape and Reel Suffix		
MC74HC1GU04DFT1	MC	74	HC1G	U04	DF	T1	SC-88A	7-Inch/3000 Unit
MC74HC1GU04DTT1	MC	74	HC1G	U04	DT	T1	TSOP5	7-Inch/3000 Unit

This document contains information on a product under development. Motorola reserves the right to change or discontinue this product without notice.



MC74HC1GU04

MAXIMUM RATINGS*

Characteristics	Symbol	Value	Unit
DC Supply Voltage	V_{CC}	-0.5 to +7.0	V
DC Input Voltage	V_{IN}	-0.5 to $V_{CC} + 0.5$	V
DC Output Voltage	V_{OUT}	-0.5 to $V_{CC} + 0.5$	V
Input Diode Current	I_{IK}	± 20	mA
Output Diode Current ($V_{OUT} < GND$; $V_{OUT} > V_{CC}$)	I_{OK}	± 20	mA
DC Output Current, per Pin	I_{OUT}	± 12.5	mA
DC Supply Current, V_{CC} and GND	I_{CC}	± 25	mA
Power dissipation in still air	P_D	200 450	mW
		SC-88A† TSOP5†	
Lead temperature, 1 mm from case for 10 s	T_L	260	°C
Storage temperature	T_{stg}	-65 to +150	°C

* Maximum Ratings are those values beyond which damage to the device may occur. Exposure to these conditions or conditions beyond those indicated may adversely affect device reliability. Functional operation under absolute-maximum-rated conditions is not implied. Functional operation should be restricted to the Recommended Operating Conditions.

† Derating — SC-88A Package: -3 mW/°C from 65° to 125°C
 — TSOP5 Package: -6 mW/°C from 65° to 125°C

RECOMMENDED OPERATING CONDITIONS

Characteristics	Symbol	Min	Max	Unit
DC Supply Voltage	V_{CC}	2.0	6.0	V
DC Input Voltage	V_{IN}	0.0	V_{CC}	V
DC Output Voltage	V_{OUT}	0.0	V_{CC}	V
Operating Temperature Range	T_A	-55	+125	°C
Input Rise and Fall Time	t_r, t_f	0	1000	ns
		$V_{CC} = 2.0V$	0	600
		$V_{CC} = 3.0V$	0	500
		$V_{CC} = 4.5V$	0	400
		$V_{CC} = 6.0V$	0	

DC ELECTRICAL CHARACTERISTICS

Symbol	Parameter	Test Conditions	V _{CC} (V)	T _A = 25°C			T _A ≤ 85°C		T _A ≤ 125°C		Unit
				Min	Typ	Max	Min	Max	Min	Max	
V _{IH}	Minimum High-Level Input Voltage		2.0	1.7			1.7		1.7		V
			3.0	2.45			2.45		2.45		
			4.5	3.60			3.60		3.60		
			6.0	4.80			4.80		4.80		
V _{IL}	Maximum Low-Level Input Voltage		2.0			0.3		0.3		0.3	V
			3.0			0.5		0.5		0.5	
			4.5			0.9		0.9		0.9	
			6.0			1.20		1.20		1.20	
V _{OH}	Minimum High-Level Output Voltage V _{IN} = V _{IH} or V _{IL}	V _{IN} = V _{IH} or V _{IL} I _{OH} = -20μA	2.0	1.8	2.0		1.8		1.8		V
			3.0	2.7	3.0		2.7		2.7		
			4.5	4.0	4.5		4.0		4.0		
		V _{IN} = V _{IH} or V _{IL} I _{OH} = -2mA I _{OH} = -2.6mA	4.5	4.18	4.33		4.13		4.08		V
			6.0	5.68	5.76		5.63		5.58		
V _{OL}	Maximum Low-Level Output Voltage V _{IN} = V _{IH} or V _{IL}	V _{IN} = V _{IH} or V _{IL} I _{OL} = 20μA	2.0		0.0	0.1		0.1		0.1	V
			3.0		0.0	0.1		0.1		0.1	
			4.5		0.0	0.1		0.1		0.1	
		V _{IN} = V _{IH} or V _{IL} I _{OL} = 2mA I _{OL} = 2.6mA	4.5			0.26		0.33		0.40	V
			6.0			0.26		0.33		0.40	
I _{IN}	Maximum Input Leakage Current	V _{IN} = 6.0V or GND	0 to 6.0			±0.1		±1.0		μA	
I _{CC}	Maximum Quiescent Supply Current	V _{IN} = V _{CC} or GND	6.0			1.0		10		40 μA	

AC ELECTRICAL CHARACTERISTICS (C_{load} = 50 pF, Input t_r = t_f = 6.0ns)

Symbol	Parameter	Test Conditions	T _A = 25°C			T _A ≤ 85°C		T _A ≤ 125°C		Unit
			Min	Typ	Max	Min	Max	Min	Max	
t _{PLH} , t _{PHL}	Maximum Propagation Delay, Input A to Y	V _{CC} = 5.0V C _L = 15 pF		7.0	15		20		25	ns
		V _{CC} = 2.0V C _L = 50 pF		48	100		125		155	
			V _{CC} = 3.0V	24	40		50		90	
			V _{CC} = 4.5V	12	20		25		35	
V _{CC} = 6.0V	9.0	17		21		26				
t _{TLH} , t _{THL}	Output Transition Time	V _{CC} = 5.0V C _L = 15 pF		5.0	10		15		20	ns
		V _{CC} = 2.0V C _L = 50 pF		50	125		155		200	
			V _{CC} = 3.0V	22	35		45		60	
			V _{CC} = 4.5V	14	25		31		38	
			V _{CC} = 6.0V	12	21		26		32	
C _{IN}	Maximum Input Capacitance		5	10		10		10	pF	

CPD	Power Dissipation Capacitance (Note 1.)	Typical @ 25°C, V _{CC} = 5.0V	
		Min	Max
		10	

1. CPD is defined as the value of the internal equivalent capacitance which is calculated from the operating current consumption without load. Average operating current can be obtained by the equation: I_{CC(OPR)} = CPD • V_{CC} • f_{in} + I_{CC}. CPD is used to determine the no-load dynamic power consumption; P_D = CPD • V_{CC}² • f_{in} + I_{CC} • V_{CC}.

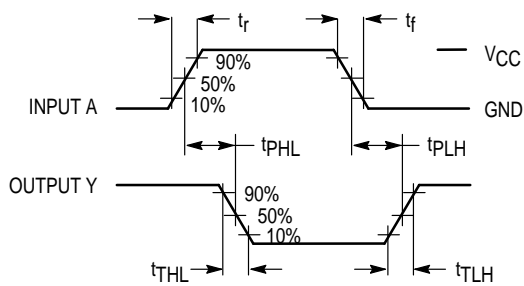
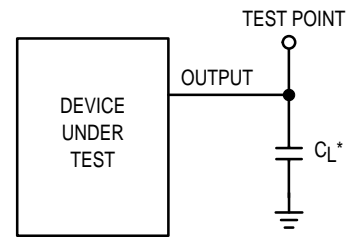

Figure 3. Switching Waveforms



* Includes all probe and jig capacitance

Figure 4. Test Circuit

OUTLINE DIMENSIONS

DF SUFFIX
5-LEAD SOT-353 PACKAGE
SC-88A
CASE 419A-01
ISSUE B

- NOTES:
1. DIMENSIONING AND TOLERANCING PER ANSI Y14.5M, 1982.
2. CONTROLLING DIMENSION: MM.

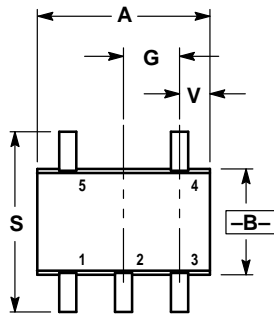

D 5 PL \oplus 0.2 (0.008) M B M

DIM	INCHES		MILLIMETERS	
	MIN	MAX	MIN	MAX
A	0.071	0.087	1.80	2.20
B	0.045	0.053	1.15	1.35
C	0.031	0.043	0.80	1.10
D	0.004	0.012	0.10	0.30
G	0.026 BSC		0.65 BSC	
H	—	0.004	—	0.10
J	0.004	0.010	0.10	0.25
K	0.004	0.012	0.10	0.30
N	0.008 REF		0.20 REF	
S	0.079	0.087	2.00	2.20
V	0.012	0.016	0.30	0.40

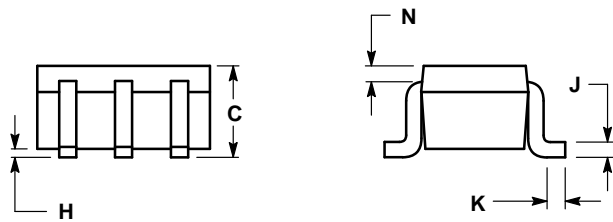

SOT-353

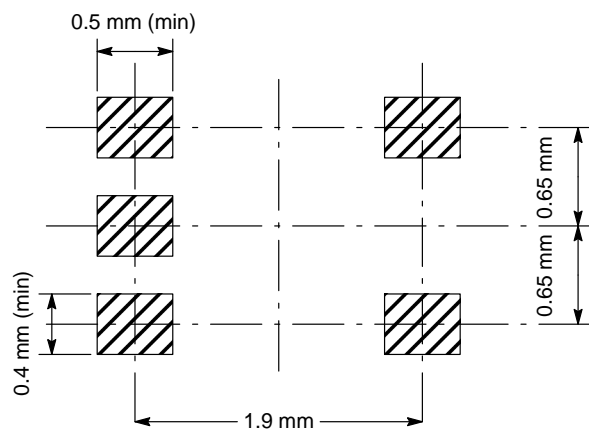

"T1" PIN ONE TOWARDS SPROCKET HOLE

SOT-353 (5 Pin) DEVICE

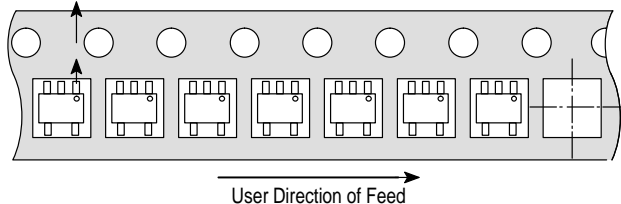

PROPOSED DT SUFFIX
5-LEAD TSSOP PACKAGE
 TSOP5
 CASE TBD
 ISSUE TBD

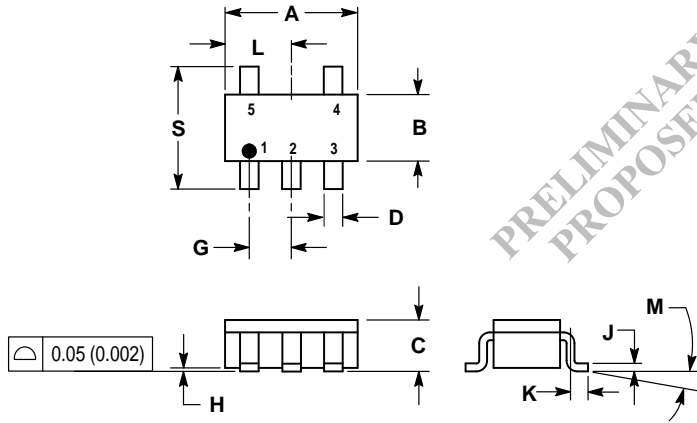

PRELIMINARY
PROPOSED

- NOTES:
1. DIMENSIONING AND TOLERANCING PER ANSI Y14.5M, 1982.
 2. CONTROLLING DIMENSION: MILLIMETER.
 3. MAXIMUM LEAD THICKNESS INCLUDES LEAD FINISH THICKNESS. MINIMUM LEAD THICKNESS IS THE MINIMUM THICKNESS OF BASE MATERIAL.

DIM	MILLIMETERS		INCHES	
	MIN	MAX	MIN	MAX
A	2.90	3.10	0.1142	0.1220
B	1.30	1.70	0.0512	0.0669
C	0.90	1.10	0.0354	0.0433
D	0.25	0.50	0.0098	0.0197
G	0.85	1.05	0.0335	0.0413
H	0.013	0.100	0.0005	0.0040
J	0.10	0.26	0.0040	0.0102
K	0.20	0.60	0.0079	0.0236
L	1.25	1.55	0.0493	0.0610
M	0°	10°	0°	10°
S	2.50	3.00	0.0985	0.1181

DO NOT DESIGN WITH THESE DIMENSIONS - PRELIMINARY

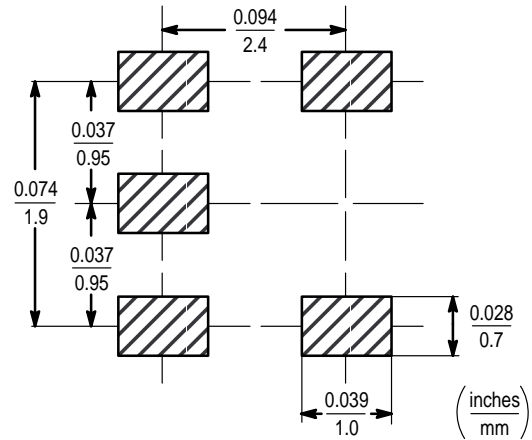
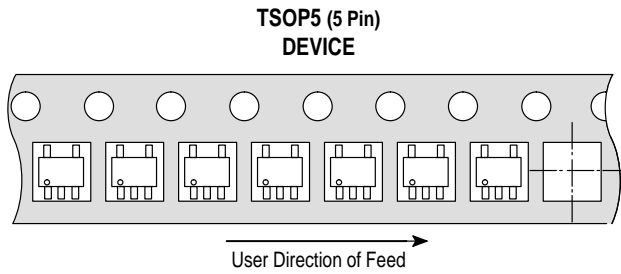

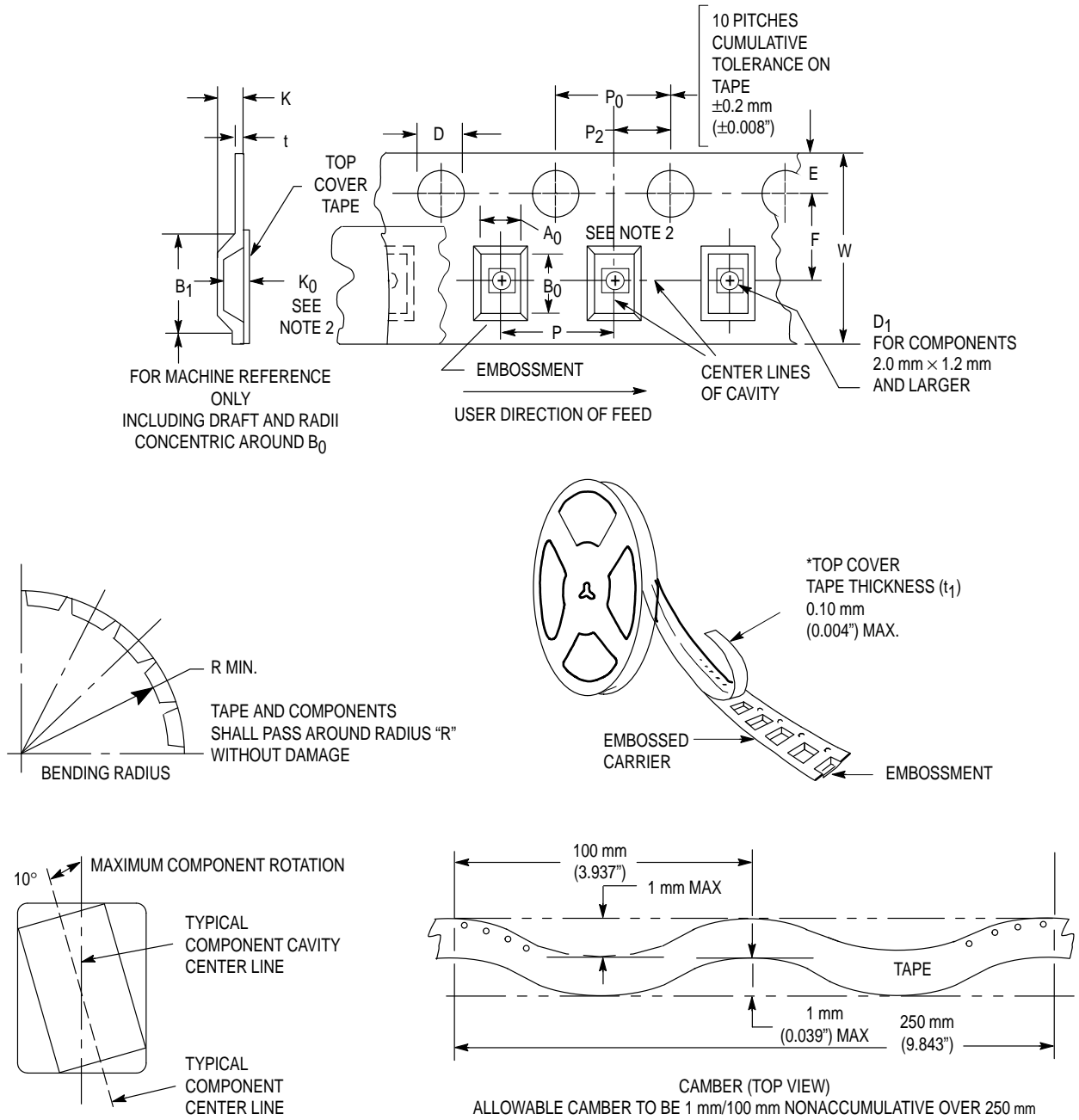

Figure 5. Carrier Tape Specifications

EMBOSSED CARRIER DIMENSIONS (See Notes 1 and 2)

Tape Size	B ₁ Max	D	D ₁	E	F	K	P	P ₀	P ₂	R	T	W
8 mm	4.35 mm (0.171")	1.5 +0.1/ -0.0 mm (0.059 +0.004/ -0.0")	1.0 mm Min (0.039")	1.75 ±0.1 mm (0.069 ±0.004")	3.5 ±0.5 mm (1.38 ±0.002")	2.4 mm (0.094")	4.0 ±0.10 mm (0.157 ±0.004")	4.0 ±0.1 mm (0.156 ±0.004")	2.0 ±0.1 mm (0.079 ±0.002")	25 mm (0.98")	0.3 ±0.05 mm (0.01 +0.0038/ -0.0002")	8.0 ±0.3 mm (0.315 ±0.012")

1. Metric Dimensions Govern—English are in parentheses for reference only.
2. A₀, B₀, and K₀ are determined by component size. The clearance between the components and the cavity must be within 0.05 mm min to 0.50 mm max. The component cannot rotate more than 10° within the determined cavity

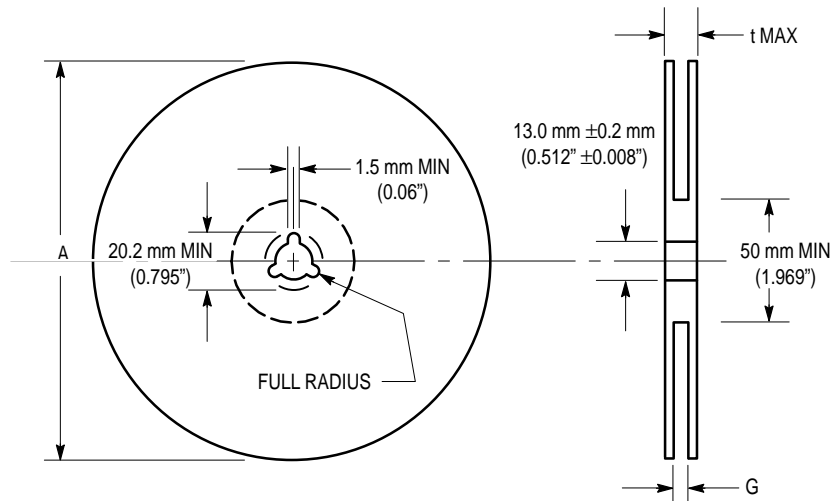

Figure 6. Reel Dimensions

REEL DIMENSIONS

Tape Size	A Max	G	t Max
8 mm	330 mm (13")	8,400 mm, +1.5 mm, -0.0 (0.33", +0.059", -0.00)	14.4 mm (0.56")

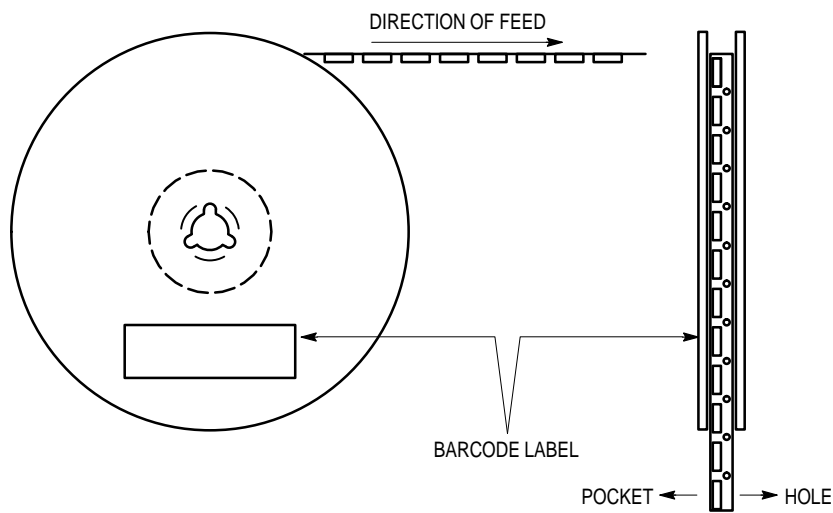

Figure 7. Reel Winding Direction

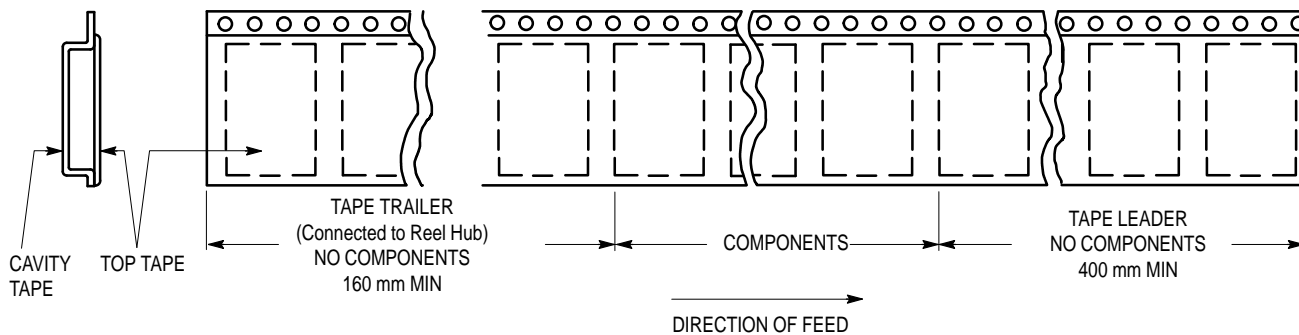



Figure 8. Tape Ends for Finished Goods

Motorola reserves the right to make changes without further notice to any products herein. Motorola makes no warranty, representation or guarantee regarding the suitability of its products for any particular purpose, nor does Motorola assume any liability arising out of the application or use of any product or circuit, and specifically disclaims any and all liability, including without limitation consequential or incidental damages. "Typical" parameters which may be provided in Motorola data sheets and/or specifications can and do vary in different applications and actual performance may vary over time. All operating parameters, including "Typicals" must be validated for each customer application by customer's technical experts. Motorola does not convey any license under its patent rights nor the rights of others. Motorola products are not designed, intended, or authorized for use as components in systems intended for surgical implant into the body, or other applications intended to support or sustain life, or for any other application in which the failure of the Motorola product could create a situation where personal injury or death may occur. Should Buyer purchase or use Motorola products for any such unintended or unauthorized application, Buyer shall indemnify and hold Motorola and its officers, employees, subsidiaries, affiliates, and distributors harmless against all claims, costs, damages, and expenses, and reasonable attorney fees arising out of, directly or indirectly, any claim of personal injury or death associated with such unintended or unauthorized use, even if such claim alleges that Motorola was negligent regarding the design or manufacture of the part. Motorola and  are registered trademarks of Motorola, Inc. Motorola, Inc. is an Equal Opportunity/Affirmative Action Employer.

Mfax is a trademark of Motorola, Inc.

How to reach us:

USA/EUROPE/Locations Not Listed: Motorola Literature Distribution; P.O. Box 5405, Denver, Colorado 80217. 1-303-675-2140 or 1-800-441-2447

JAPAN: Nippon Motorola Ltd.; SPD, Strategic Planning Office, 141, 4-32-1 Nishi-Gotanda, Shinagawa-ku, Tokyo, Japan. 81-3-5487-8488

Customer Focus Center: 1-800-521-6274

Mfax™: RMFAX0@email.sps.mot.com – TOUCHTONE 1-602-244-6609
 Motorola Fax Back System – US & Canada ONLY 1-800-774-1848
 – http://sps.motorola.com/mfax/

ASIA/PACIFIC: Motorola Semiconductors H.K. Ltd.; 8B Tai Ping Industrial Park, 51 Ting Kok Road, Tai Po, N.T., Hong Kong. 852-26629298

HOME PAGE: <http://motorola.com/sps/>

