

## Thyristor/Diode Modules M## 600

### Absolute Maximum Ratings

$V_{RRM}$ $V_{DRM}$ [V]							
	MCC	MCD	MDC	MCA	MCK	MCDA	MDCA
2000	600-20io1W	600-20io1W	600-20io1W	600-20io1W	600-20io1W	600-20io1W	600-20io1W
2200	600-22io1W	600-22io1W	600-22io1W	600-22io1W	600-22io1W	600-22io1W	600-22io1W

	VOLTAGE RATINGS	MAXIMUM LIMITS	UNITS
$V_{DRM}$	Repetitive peak off-state voltage <sup>1)</sup>	2000-2200	V
$V_{DSM}$	Non-repetitive peak off-state voltage <sup>1)</sup>	2000-2200	V
$V_{RRM}$	Repetitive peak reverse voltage <sup>1)</sup>	2000-2200	V
$V_{RSM}$	Non-repetitive peak reverse voltage <sup>1)</sup>	2100-2300	V

	OTHER RATINGS	MAXIMUM LIMITS	UNITS
$I_{T(AV)M}$	Maximum average on-state current, $T_{water} = 17^{\circ}C$ , 4l/min <sup>2), 3)</sup>	710	A
$I_{T(AV)M}$	Maximum average on-state current. $T_{water} = 40^{\circ}C$ , 4l/min <sup>2), 3)</sup>	600	A
$I_{T(AV)M}$	Maximum average on-state current. $T_{water} = 85^{\circ}C$ , 4l/min <sup>2), 3)</sup>	348	A
$I_{T(RMS)M}$	Nominal RMS on-state current, $T_{water} = 17^{\circ}C$ , 4l/min <sup>2), 3)</sup>	1116	A
$I_{T(d.c.)}$	D.C. on-state current, $T_{water} = 17^{\circ}C$ , 4l/min <sup>3)</sup>	921	A
$I_{TSM}$	Peak non-repetitive surge $t_p = 10$ ms, $V_{RM} = 60\%V_{RRM}$ <sup>4)</sup>	16.5	kA
$I_{TSM2}$	Peak non-repetitive surge $t_p = 10$ ms, $V_{RM} \leq 10V$ <sup>4)</sup>	18.2	kA
$I^2t$	$I^2t$ capacity for fusing $t_p = 10$ ms, $V_{RM} = 60\%V_{RRM}$ <sup>4)</sup>	$1.36 \times 10^6$	$A^2s$
$I^2t$	$I^2t$ capacity for fusing $t_p = 10$ ms, $V_{RM} \leq 10V$ <sup>3)</sup>	$1.66 \times 10^6$	$A^2s$
$(di/dt)_{cr}$	Critical rate of rise of on-state current (repetitive) <sup>5)</sup>	150	A/ $\mu s$
	Critical rate of rise of on-state current (non-repetitive) <sup>5)</sup>	300	A/ $\mu s$
$V_{RGM}$	Peak reverse gate voltage	5	V
$P_{G(AV)}$	Mean forward gate power	4	W
$P_{GM}$	Peak forward gate power	30	W
$V_{ISOL}$	Isolation Voltage <sup>6)</sup>	3500	V
$T_{vj op}$	Operating temperature range	-40 to +125	$^{\circ}C$
$T_{stg}$	Storage temperature range	-40 to +150	$^{\circ}C$

#### Notes:

- De-rating factor of 0.13% per  $^{\circ}C$  is applicable for  $T_{vj}$  below  $25^{\circ}C$ .
- Single phase; 50 Hz,  $180^{\circ}$  half-sinewave.
- Current ratings do not include adjustments, which may be necessary due to heat being returned by cable connections.
- Half-sinewave,  $125^{\circ}C$   $T_{vj}$  initial.
- $V_D = 67\% V_{DRM}$ ,  $I_{FG} = 2$  A,  $t_r \leq 0.5\mu s$ ,  $T_C = 125^{\circ}C$ .
- AC RMS voltage, 50 Hz, 1min test

**Thyristor Characteristics**

	PARAMETER	MIN.	TYP.	MAX.	TEST CONDITIONS <sup>1)</sup>	UNITS
V <sub>TM</sub>	Maximum peak on-state voltage	-	-	1.69	I <sub>TM</sub> = 1800 A	V
V <sub>TM</sub>	Maximum peak on-state voltage	-	-	1.16	I <sub>TM</sub> = 600 A	V
V <sub>T0</sub>	Threshold voltage	-	-	0.88		V
r <sub>T</sub>	Slope resistance	-	-	0.46		mΩ
(dv/dt) <sub>cr</sub>	Critical rate of rise of off-state voltage	1000	-	-	V <sub>D</sub> = 80% V <sub>DRM</sub> , linear ramp, Gate o/c	V/μs
I <sub>DRM</sub>	Peak off-state current	-	-	70	Rated V <sub>DRM</sub>	mA
I <sub>RRM</sub>	Peak reverse current	-	-	70	Rated V <sub>RRM</sub>	mA
V <sub>GT</sub>	Gate trigger voltage	-	-	3.0	T <sub>vj</sub> = 25°C, V <sub>D</sub> = 10 V, I <sub>T</sub> = 3 A	V
I <sub>GT</sub>	Gate trigger current	-	-	300		mA
I <sub>H</sub>	Holding current	-	-	1000	T <sub>vj</sub> = 25°C	mA
t <sub>gd</sub>	Gate controlled turn-on delay time	-	0.6	1.5	I <sub>FG</sub> = 2 A, t <sub>r</sub> = 0.5 μs, V <sub>D</sub> = 67%V <sub>DRM</sub> , I <sub>TM</sub> = 2000 A, di/dt = 10 A/μs, T <sub>vj</sub> = 25°C	μs
t <sub>gt</sub>	Turn-on time	-	1.2	2.5		μs
Q <sub>rr</sub>	Recovered Charge	-	3000	-		μC
Q <sub>ra</sub>	Recovered Charge, 50% chord	-	1800	2400	I <sub>TM</sub> = 1000 A, t <sub>p</sub> = 1 ms, di/dt = 10A/μs, V <sub>R</sub> = 50 V	μC
I <sub>rm</sub>	Reverse recovery current	-	140	-		A
t <sub>rr</sub>	Reverse recovery time, 50% chord	-	26	-		μs
t <sub>q</sub>	Turn-off time	-	200	-	I <sub>TM</sub> = 1000 A, t <sub>p</sub> = 1 ms, di/dt = 10 A/μs, V <sub>R</sub> = 50 V, V <sub>DR</sub> = 80%V <sub>DRM</sub> , dv <sub>DR</sub> /dt = 20 V/μs	μs
		-	300	-	I <sub>TM</sub> = 1000 A, t <sub>p</sub> = 1 ms, di/dt = 10 A/μs, V <sub>R</sub> = 50 V, V <sub>DR</sub> = 80%V <sub>DRM</sub> , dv <sub>DR</sub> /dt = 200 V/μs	

**Diode Characteristics**

	PARAMETER	MIN.	TYP.	MAX.	TEST CONDITIONS <sup>1)</sup>	UNITS
V <sub>FM</sub>	Maximum peak forward voltage	-	-	1.11	I <sub>TM</sub> = 1800 A	V
V <sub>T0</sub>	Threshold voltage	-	-	0.72		V
r <sub>T</sub>	Slope resistance	-	-	0.143		mΩ
I <sub>RRM</sub>	Peak reverse current	-	-	50	Rated V <sub>RRM</sub>	mA
Q <sub>rr</sub>	Recovered Charge	-	2200	-		μC
Q <sub>ra</sub>	Recovered Charge, 50% chord	-	1800	2250	I <sub>TM</sub> = 1000 A, t <sub>p</sub> = 1 ms, di/dt = 10 A/μs, V <sub>R</sub> = 50 V	μC
I <sub>rm</sub>	Reverse recovery current	-	145	-		A
t <sub>rr</sub>	Reverse recovery time, 50% chord	-	25	-		μs

**Module Characteristics**

	PARAMETER	MIN.	TYP.	MAX.	TEST CONDITIONS <sup>1)</sup>	UNITS
R <sub>thJC</sub>	Thermal resistance, junction to case	-	-	0.09	Single Thyristor/Single Diode	K/W
F <sub>1</sub>	Mounting force (to heatsink)	4.25	-	5.75	2)	Nm
F <sub>2</sub>	Mounting force (to terminals)	10.2	-	13.8		Nm
W <sub>t</sub>	Weight	-	1.8	-		kg

**Notes:**

- 1) Unless otherwise indicated T<sub>vj</sub>=125°C.
- 2) Screws must be lubricated

## Notes on Ratings and Characteristics

### 1.0 Voltage Grade Table

Voltage Grade	$V_{DRM}$ $V_{DSM}$ $V_{RRM}$ V	$V_{RSM}$ V	$V_D$ $V_R$ DC V
20	2000	2100	1250
22	2200	2300	1350

### 2.0 Extension of Voltage Grades

This report is applicable to other voltage grades when supply has been agreed by Sales/Production.

### 3.0 De-rating Factor

A blocking voltage de-rating factor of 0.13%/°C is applicable to this device for  $T_{vj}$  below 25°C.

### 4.0 Repetitive dv/dt

Standard dv/dt is 1000V/μs.

### 5.0 Snubber Components

When selecting snubber components, care must be taken not to use excessively large values of snubber capacitor or excessively small values of snubber resistor. Such excessive component values may lead to device damage due to the large resultant values of snubber discharge current. If required, please consult the factory for assistance.

### 6.0 Rate of rise of on-state current

The maximum un-primed rate of rise of on-state current must not exceed 300A/μs at any time during turn-on on a non-repetitive basis. For repetitive performance, the on-state rate of rise of current must not exceed 150A/μs at any time during turn-on. Note that these values of rate of rise of current apply to the total device current including that from any local snubber network.

### 7.0 Gate Drive

The nominal requirement for a typical gate drive is illustrated below. An open circuit voltage of at least 30V is assumed. This gate drive must be applied when using the full di/dt capability of the device.

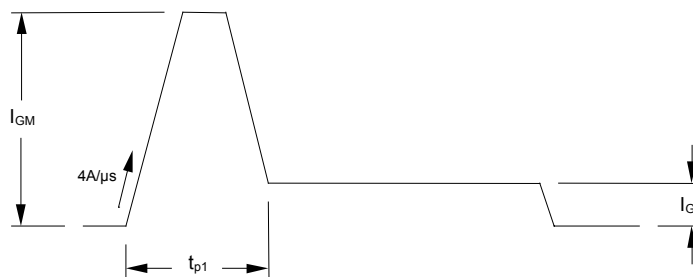

The magnitude of  $I_{GM}$  should be between five and ten times  $I_{GT}$ , which is shown on page 2. Its duration ( $t_{p1}$ ) should be 20μs or sufficient to allow the anode current to reach ten times  $I_L$ , whichever is greater. Otherwise, an increase in pulse current could be needed to supply the necessary charge to trigger. The 'back-porch' current  $I_G$  should remain flowing for the same duration as the anode current and have a magnitude in the order of 1.5 times  $I_{GT}$ .

## 8.0 Computer Modelling Parameters

### 8.1 Thyristor Dissipation Calculations

$$I_{AV} = \frac{-V_{T0} + \sqrt{V_{T0}^2 + 4 \cdot ff^2 \cdot r_T \cdot W_{AV}}}{2 \cdot ff^2 \cdot r_T} \quad \text{and:} \quad W_{AV} = \frac{\Delta T}{R_{th}}$$

$$\Delta T = T_{j \max} - T_K$$

Where  $V_{T0} = 0.88 \text{ V}$ ,  $r_T = 0.46 \text{ m}\Omega$ ,

$R_{th}$  = Supplementary thermal impedance, see table below and

$ff$  = Form factor, see table below.

Supplementary Thermal Impedance							
Conduction Angle	30°	60°	90°	120°	180°	270°	d.c.
Square wave	0.0976	0.0955	0.0942	0.0933	0.0920	0.0907	0.09
Sine wave	0.0950	0.0933	0.0924	0.0917	0.0902		

Form Factors							
Conduction Angle	30°	60°	90°	120°	180°	270°	d.c.
Square wave	3.464	2.449	2	1.732	1.414	1.149	1
Sine wave	3.98	2.778	2.22	1.879	1.57		

### 8.2 Calculating $V_T/V_F$ using ABCD Coefficients

The on-state/forward characteristics,  $I_T$  vs.  $V_T$ , on pages 6 & 9 are represented in two ways;

- the well established  $V_{T0}$  and  $r_T$  tangent used for rating purposes and
- a set of constants A, B, C, D, forming the coefficients of the representative equation for  $V_T$  in terms of  $I_T$  given below:

$$V_T = A + B \cdot \ln(I_T) + C \cdot I_T + D \cdot \sqrt{I_T}$$

The constants, derived by curve fitting software, are given below for both hot and cold characteristics. The resulting values for  $V_T$  agree with the true device characteristic over a current range, which is limited to that plotted.

Thyristor coefficients		
	25°C	125°C
A	2.296566505	0.617965877
B	-0.3387419	0.01056009
C	$-6.25982 \times 10^{-5}$	$2.13809 \times 10^{-4}$
D	0.04767141	0.01430982
Diode coefficients		
	25°C	125°C
A	0.578986196	-0.214099731
B	0.1048225	0.2916851
C	$1.61162 \times 10^{-4}$	$5.15459 \times 10^{-4}$
D	$-7.480625 \times 10^{-3}$	-0.04232154

8.3D.C. Thermal Impedance Calculation

$$r_t = \sum_{p=1}^{p=n} r_p \cdot \left( 1 - e^{-\frac{t}{\tau_p}} \right)$$

Where  $p = 1$  to  $n$

- $n$  = number of terms in the series
- $t$  = Duration of heating pulse in seconds.
- $r_t$  = Thermal resistance at time  $t$ .
- $r_p$  = Amplitude of  $p_{th}$  term.
- $\tau_p$  = Time Constant of  $r_{th}$  term.

The coefficients for this device are shown in the tables below:

D.C.					
Term	1	2	3	4	5
$r_p$	0.07972	$3.64310 \times 10^{-3}$	$4.87795 \times 10^{-3}$	$1.91134 \times 10^{-3}$	$2.146406 \times 10^{-3}$
$\tau_p$	4.46119	0.71394	0.06312	$5.07740 \times 10^{-3}$	$6.07258 \times 10^{-3}$

9.0 Reverse recovery ratings

(i)  $Q_{ra}$  is based on 50%  $I_{rm}$  chord as shown in Fig. 1

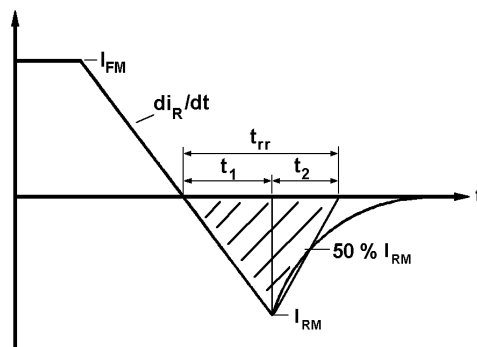

Fig. 1

(ii)  $Q_{rr}$  is based on a 150  $\mu s$  integration time i.e.

$$Q_{rr} = \int_0^{150 \mu s} i_{rr} . dt$$

(iii)

$$K \text{ Factor} = \frac{t_1}{t_2}$$

**Thyristor Curves**

Figure 1 - On-state characteristics of Limit device

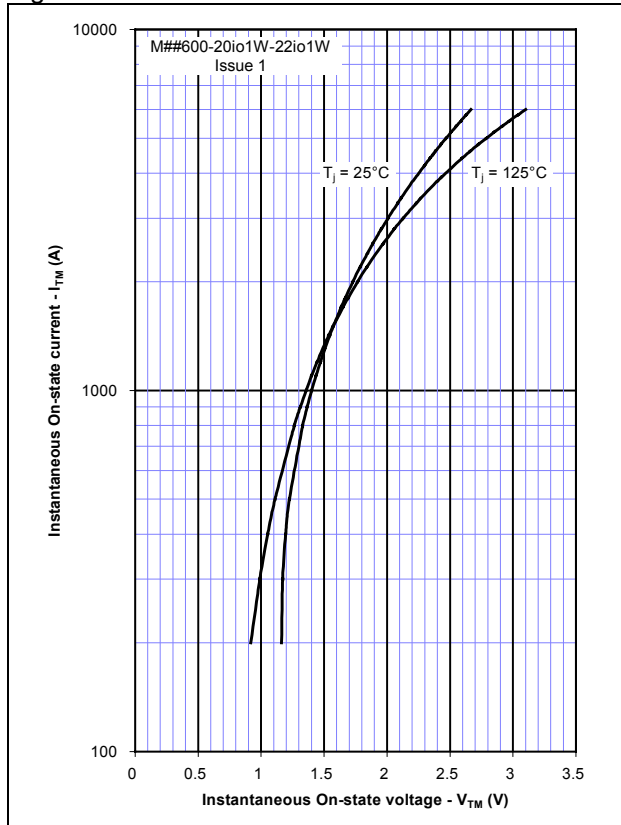

Figure 2 - Transient thermal impedance

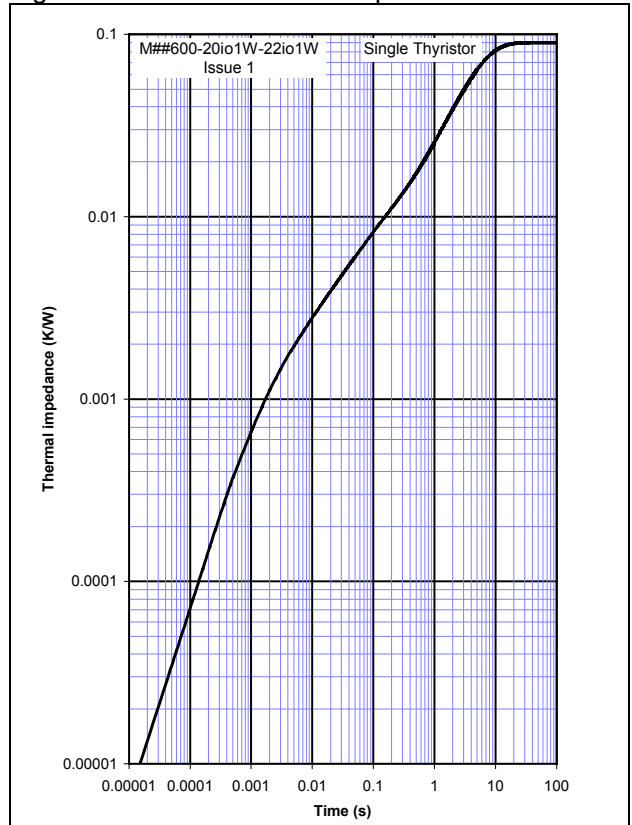

Figure 3 - Gate characteristics - Trigger limits

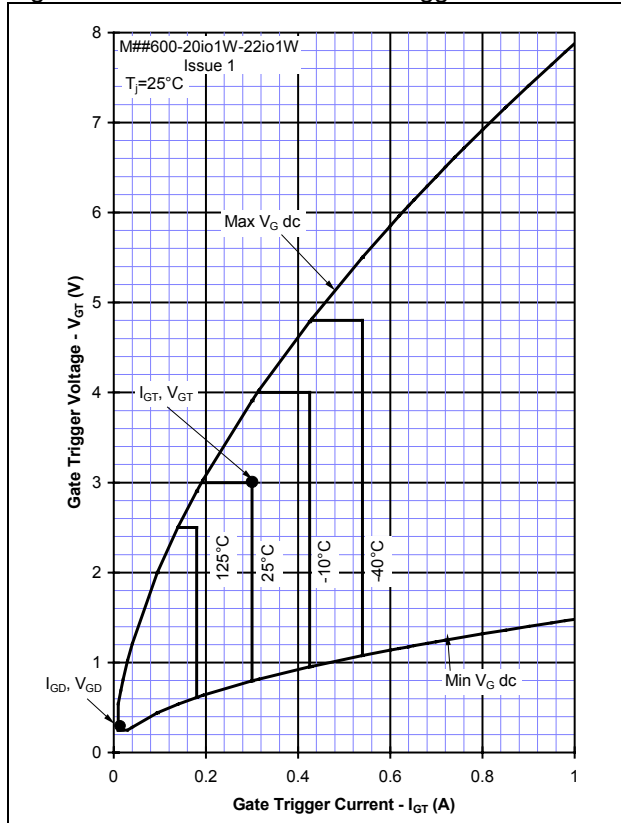

Figure 4 - Gate characteristics - Power curves

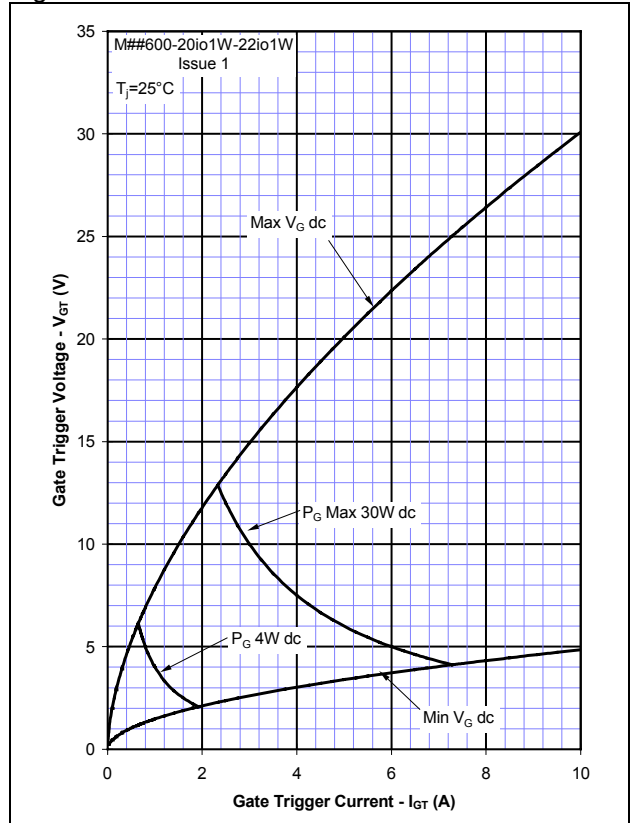

Figure 5 - Total recovered charge,  $Q_{rr}$

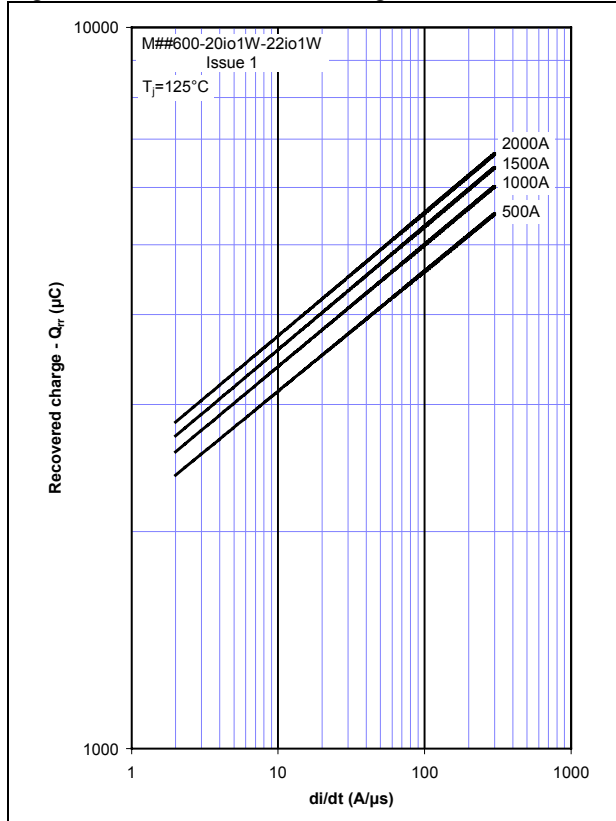

Figure 6 - Recovered charge,  $Q_{ra}$  (50% chord)

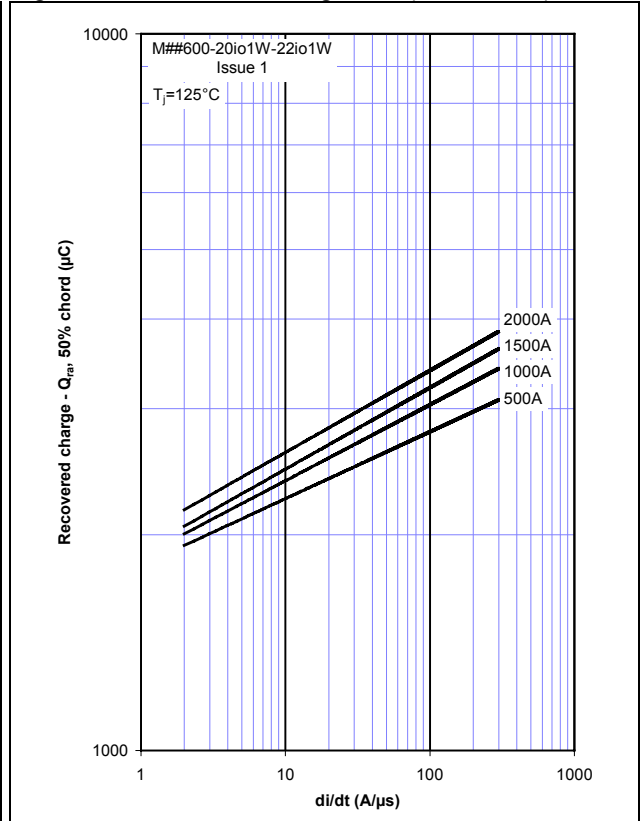

Figure 7 - Peak reverse recovery current,  $I_{rm}$

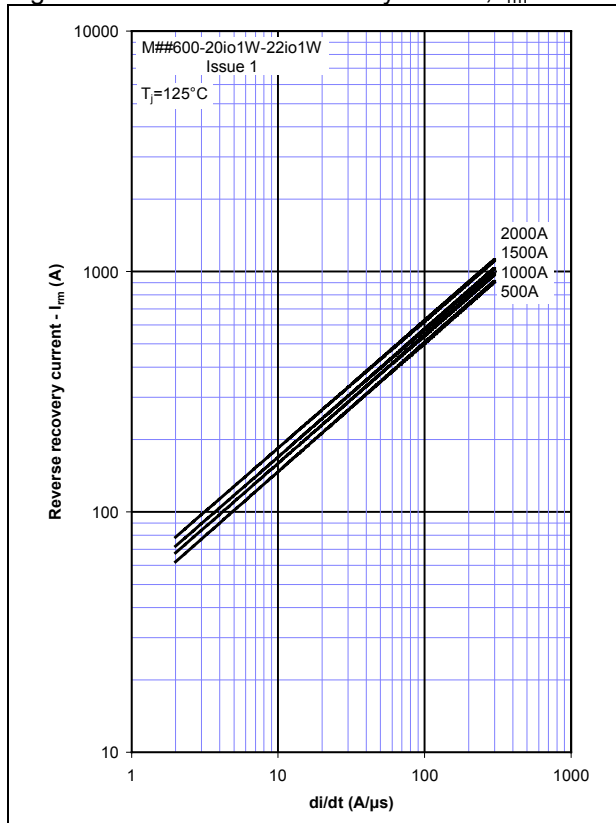

Figure 8 - Maximum recovery time,  $t_{rr}$  (50% chord)

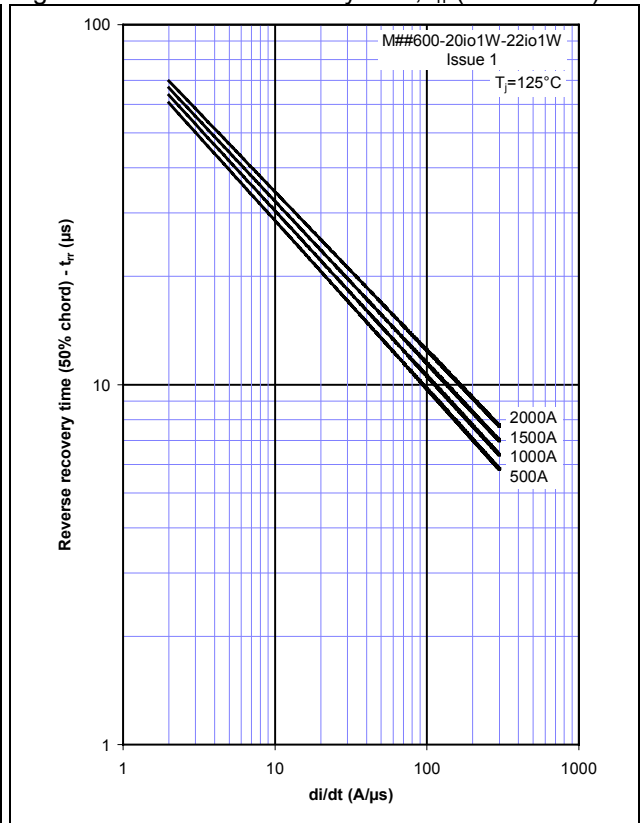

Figure 9 - On-state current vs. Power dissipation  
- Sine wave

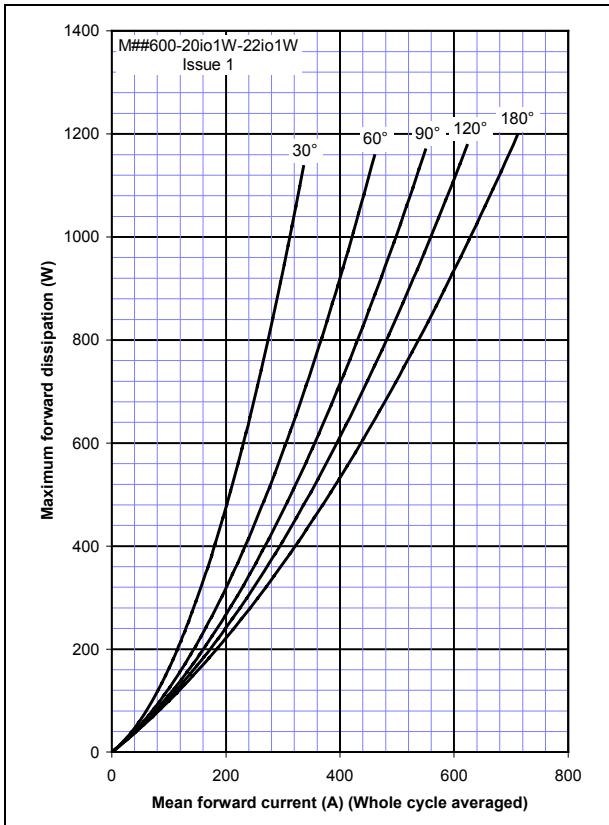

Figure 10 - On-state current vs. water temperature  
- Sine wave

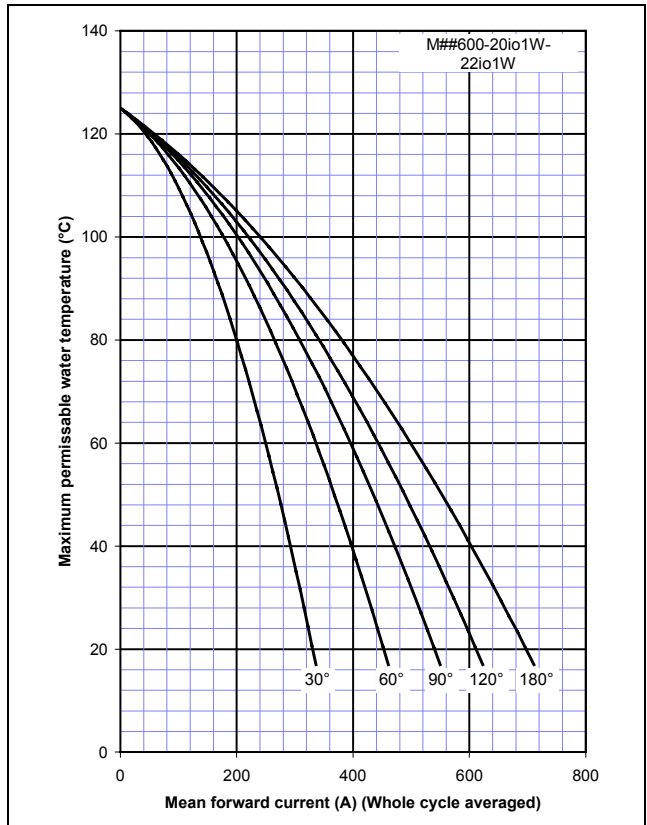

Figure 11 - On-state current vs. Power dissipation  
- Square wave

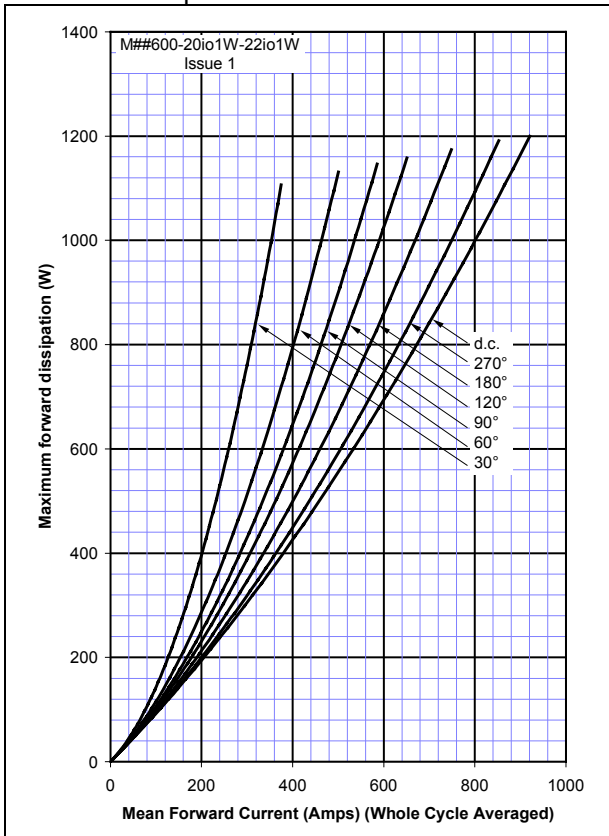

Figure 12 - On-state current vs. water temperature  
- Square wave

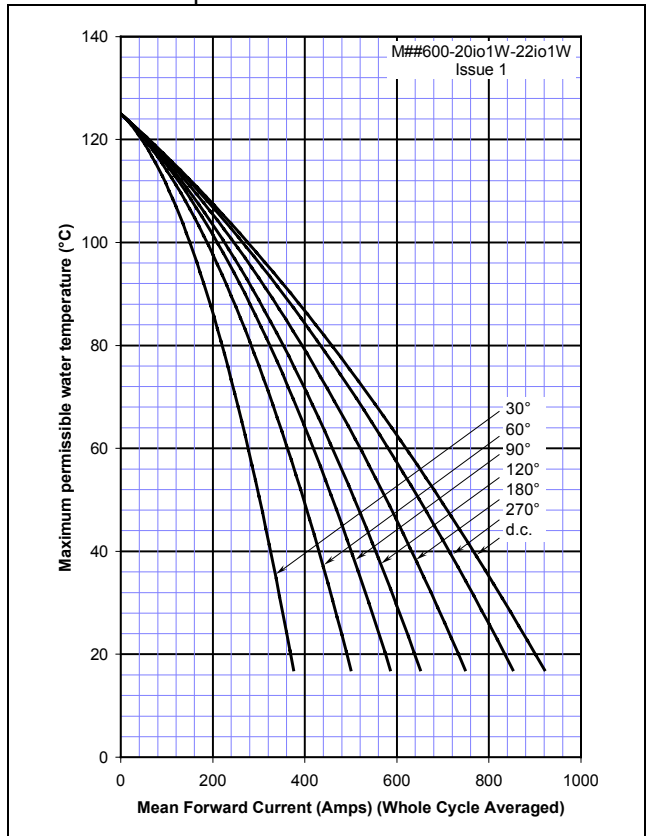



Figure 13 - Maximum surge and I<sup>2</sup>t Ratings

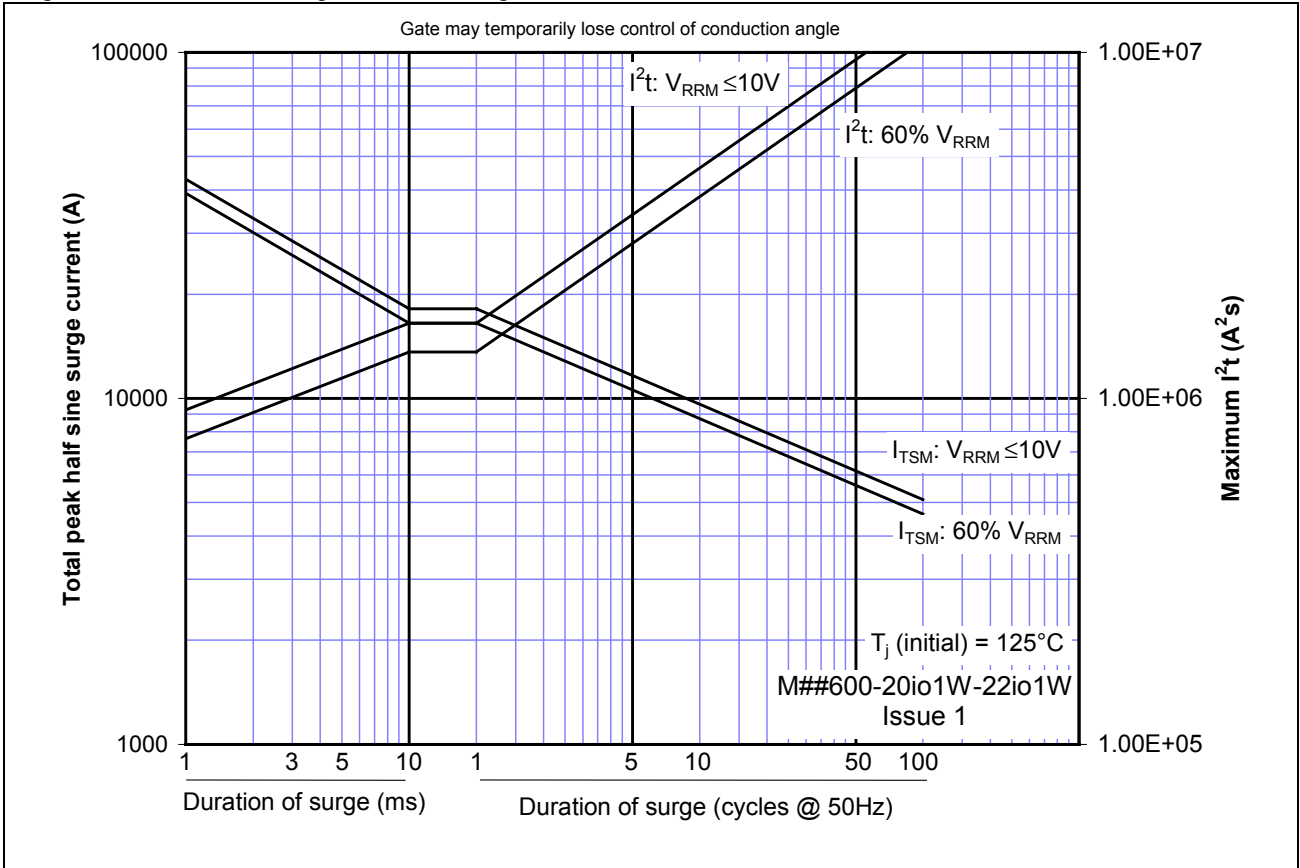
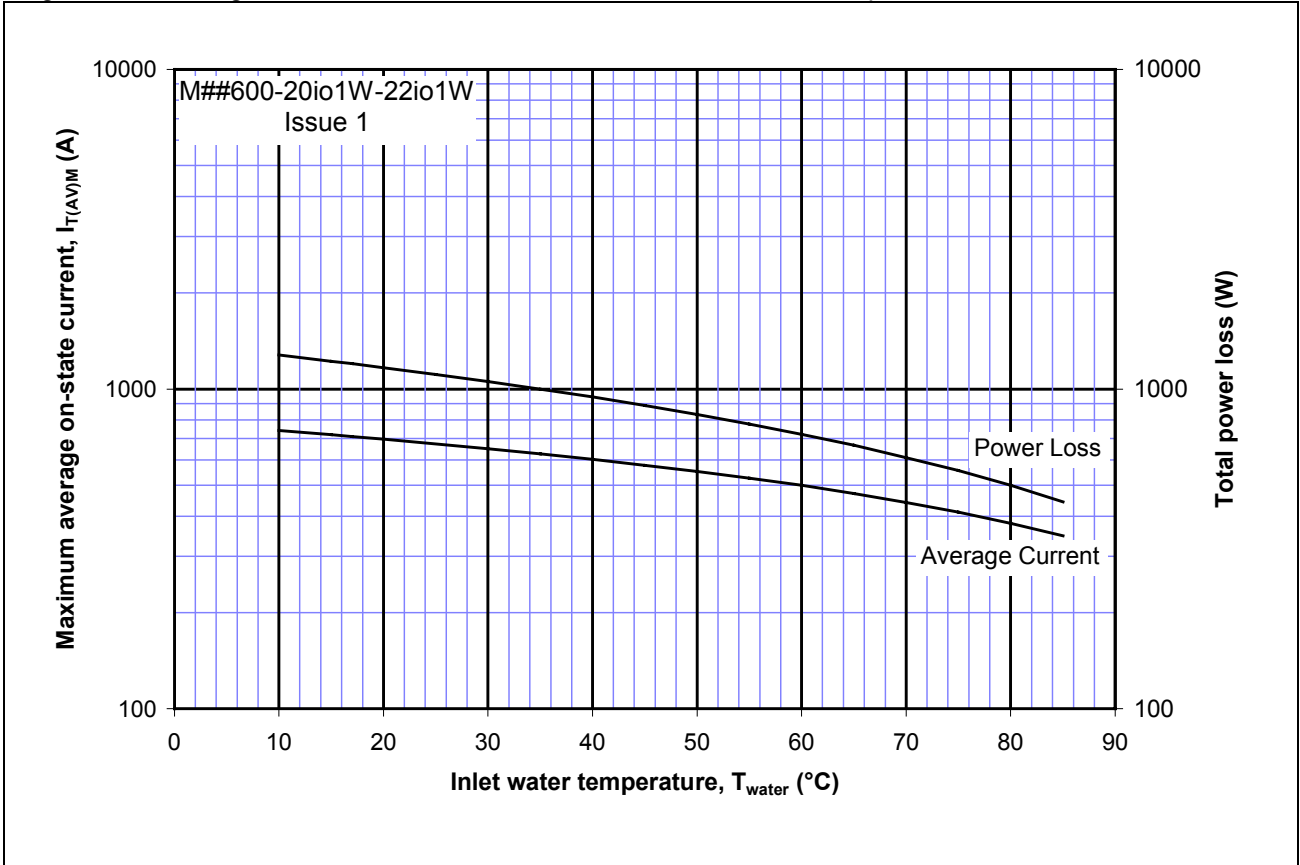

Figure 14 – Average on-state current and Power loss Vs. Inlet water temperature



**Diode curves**

Figure 15 - Total recovered charge,  $Q_{rr}$

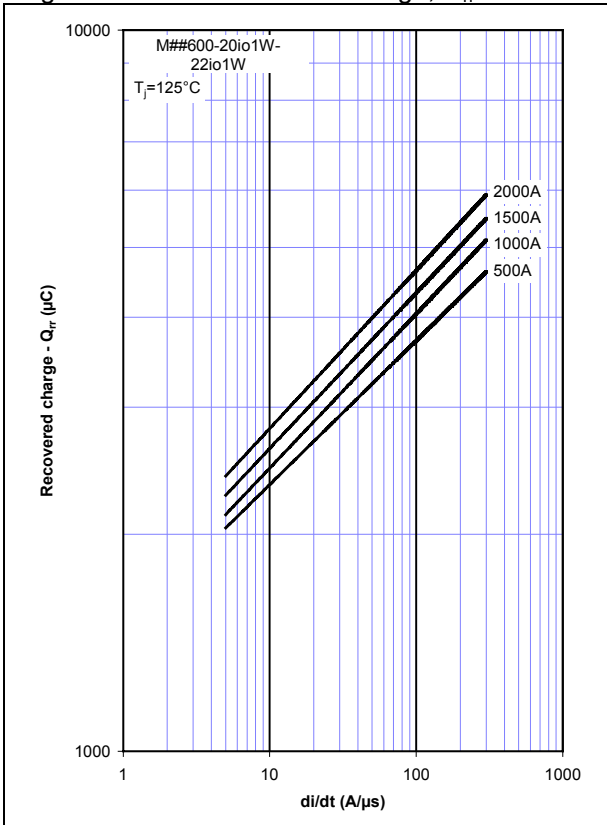

Figure 16 - Recovered charge,  $Q_{ra}$  (50% chord)

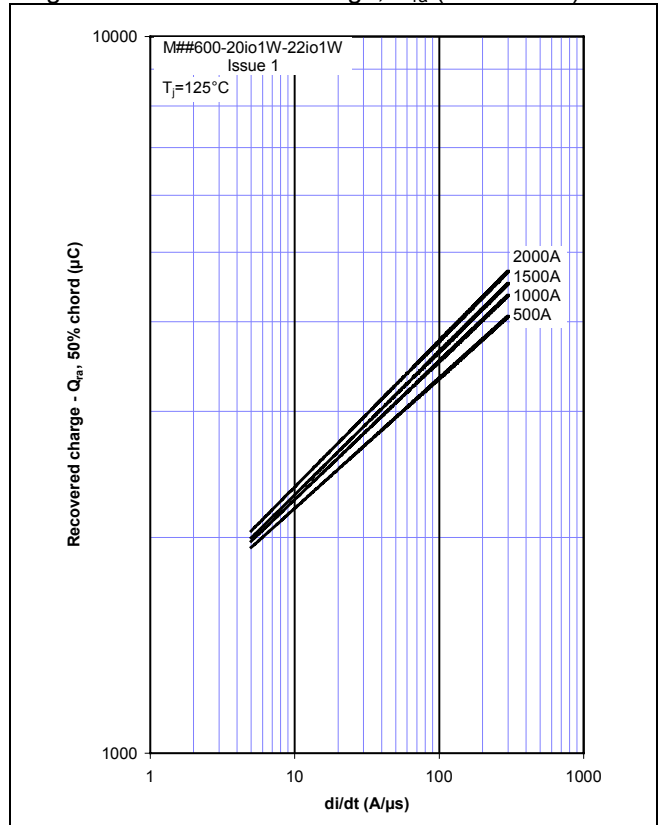

Figure 17 - Peak reverse recovery current,  $I_{rm}$

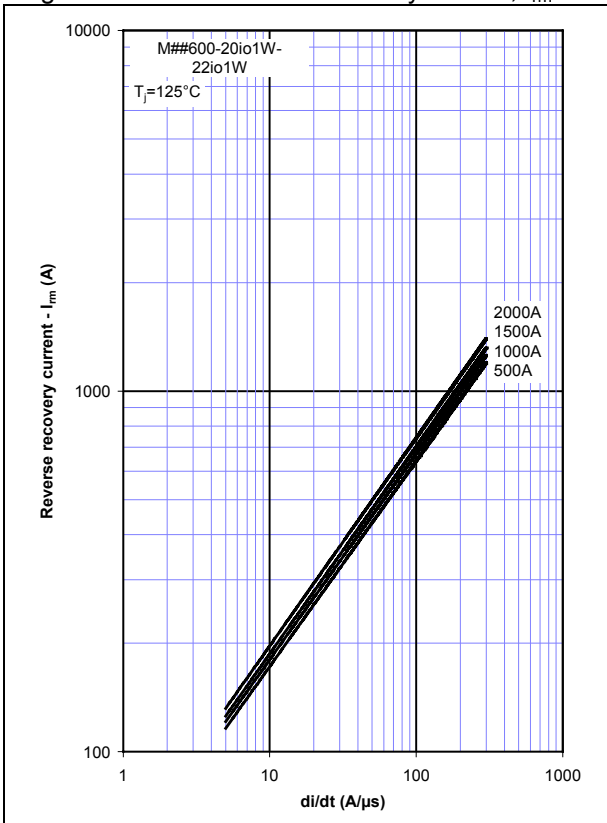

Figure 18 - Maximum recovery time,  $t_{rr}$  (50% chord)

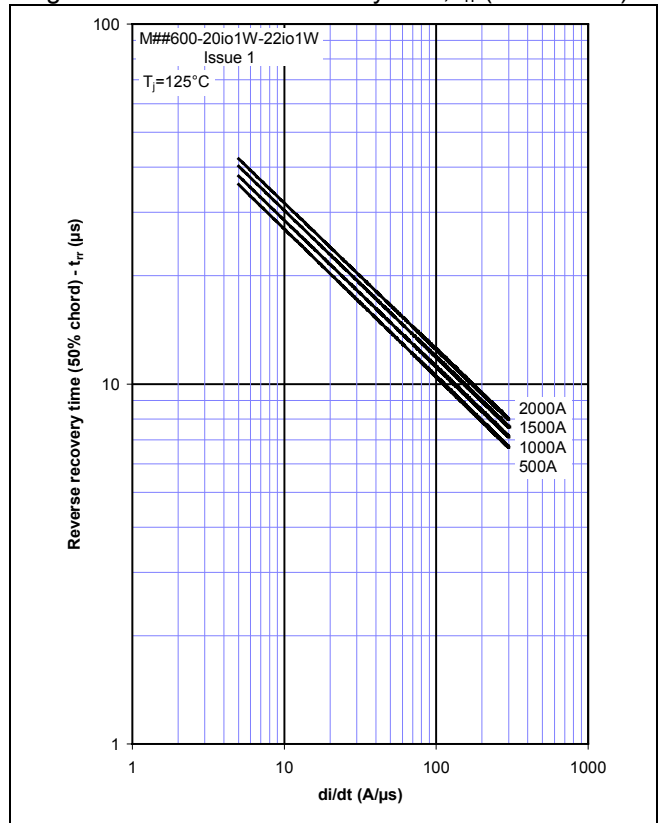
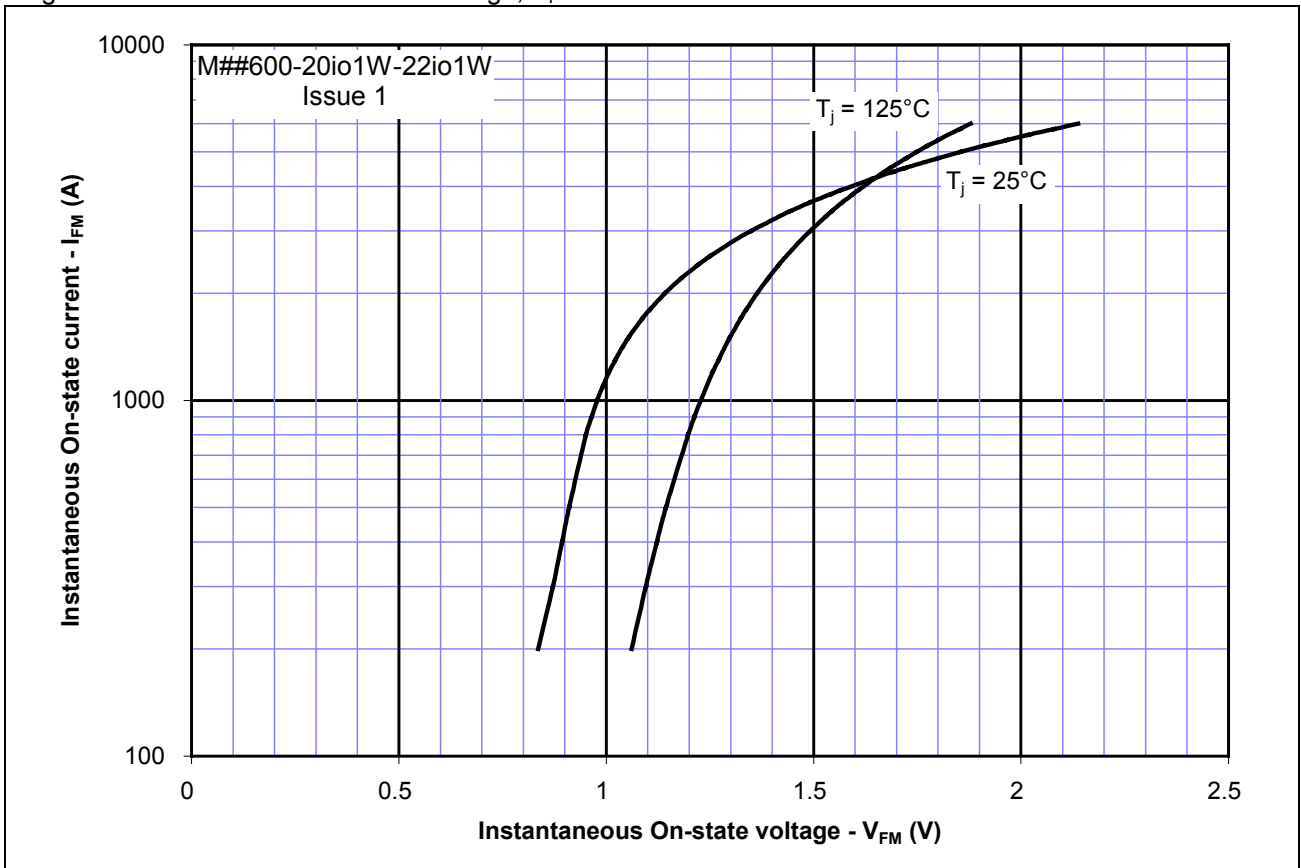
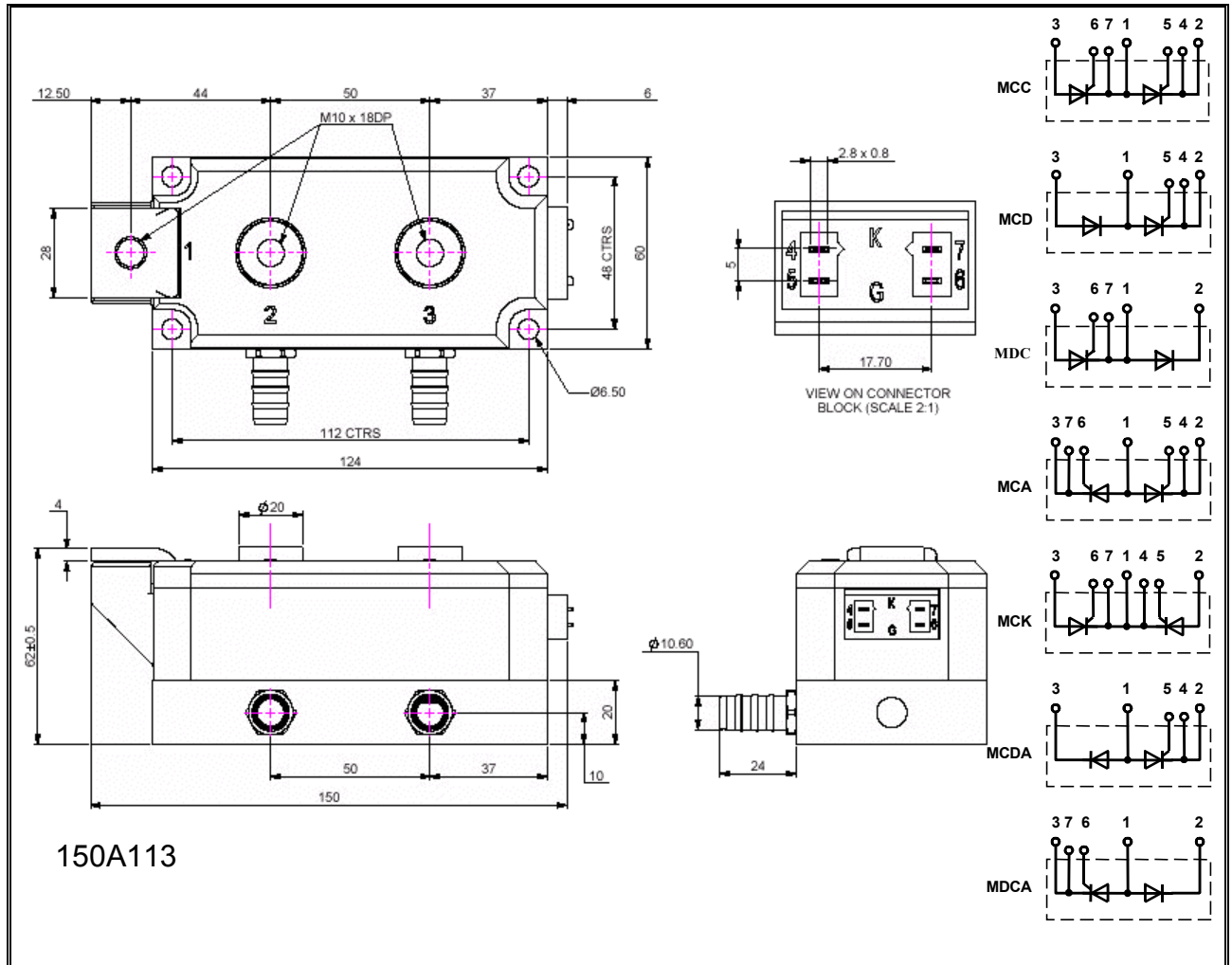

Figure 19 – Instantaneous forward voltage,  $V_F$



Outline Drawing & Ordering Information



ORDERING INFORMATION

(Please quote 12 digit code as below)

M	##	600	◆◆	io	1	W
Fixed Type Code	Configuration code CC, CD, DC, CA, CK, CDA, DCA	Average Current Rating	Voltage code $V_{DRM}/100$ 20-22	i = Critical dv/dt 1000 V/μs o = Typical turn-off time	Fixed Version Code	Water cooled base

Order code: MCD600-20io1W – MCD configuration, 2000V  $V_{RRM}$ , water cooled base

**IXYS Semiconductor GmbH**  
Edisonstraße 15  
D-68623 Lampertheim  
Tel: +49 6206 503-0  
Fax: +49 6206 503-627  
E-mail: [marcom@ixys.de](mailto:marcom@ixys.de)



[www.ixys.com](http://www.ixys.com)

**Westcode Semiconductors Ltd**  
Langley Park Way, Langley Park,  
Chippenham, Wiltshire, SN15 1GE.  
Tel: +44 (0)1249 444524  
Fax: +44 (0)1249 659448  
E-mail: [WSL.sales@westcode.com](mailto:WSL.sales@westcode.com)

**IXYS Corporation**  
3540 Bassett Street  
Santa Clara CA 95054 USA  
Tel: +1 (408) 982 0700  
Fax: +1 (408) 496 0670  
E-mail: [sales@ixys.net](mailto:sales@ixys.net)



An IXYS Company

[www.westcode.com](http://www.westcode.com)

**Westcode Semiconductors Inc**  
3270 Cherry Avenue  
Long Beach CA 90807 USA  
Tel: +1 (562) 595 6971  
Fax: +1 (562) 595 8182  
E-mail: [WSI.sales@westcode.com](mailto:WSI.sales@westcode.com)

The information contained herein is confidential and is protected by Copyright. The information may not be used or disclosed except with the written permission of and in the manner permitted by the proprietors IXYS Semiconductors GmbH.

© IXYS Semiconductor GmbH.

In the interest of product improvement, IXYS reserves the right to change specifications at any time without prior notice.

Devices with a suffix code (2-letter, 3-letter or letter/digit/letter combination) added to their generic code are not necessarily subject to the conditions and limits contained in this report.