

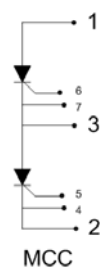
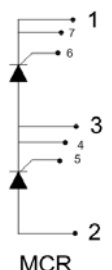
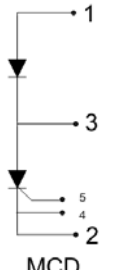
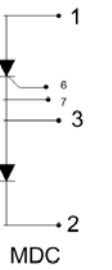

## Thyristor/Diode Modules MC#500

### Absolute Maximum Ratings

$V_{RRM}$ $V_{DRM}$ [V]				
3000	500-30io7	500-30io7	500-30io7	500-30io7
3600	500-36io7	500-36io7	500-36io7	500-36io7

	VOLTAGE RATINGS	MAXIMUM LIMITS	UNITS
$V_{DRM}$	Repetitive peak off-state voltage <sup>1)</sup>	3000-3600	V
$V_{DSM}$	Non-repetitive peak off-state voltage <sup>1)</sup>	3100-3700	V
$V_{RRM}$	Repetitive peak reverse voltage <sup>1)</sup>	3000-3600	V
$V_{RSM}$	Non-repetitive peak reverse voltage <sup>1)</sup>	3100-3700	V

	OTHER RATINGS	MAXIMUM LIMITS	UNITS
$I_{T(AV)M}$	Maximum average on-state current, $T_C = 85^\circ\text{C}$ <sup>2)</sup>	500	A
$I_{T(AV)M}$	Maximum average on-state current, $T_C = 100^\circ\text{C}$ <sup>2)</sup>	347	A
$I_{T(RMS)M}$	Nominal RMS on-state current, $T_C = 55^\circ\text{C}$ <sup>2)</sup>	1181	A
$I_{T(d.c.)}$	D.C. on-state current, $T_C = 55^\circ\text{C}$	948	A
$I_{TSM}$	Peak non-repetitive surge $t_p = 10$ ms, $V_{RM} = 60\%V_{RRM}$ <sup>3)</sup>	16.2	kA
$I_{TSM2}$	Peak non-repetitive surge $t_p = 10$ ms, $V_{RM} \leq 10$ V <sup>3)</sup>	18.0	kA
$I^2t$	$I^2t$ capacity for fusing $t_p = 10$ ms, $V_{RM} = 60\%V_{RRM}$ <sup>3)</sup>	1310	$\text{kA}^2\text{s}$
$I^2t$	$I^2t$ capacity for fusing $t_p = 10$ ms, $V_{RM} \leq 10$ V <sup>3)</sup>	1620	$\text{kA}^2\text{s}$
$(di/dt)_{cr}$	Critical rate of rise of on-state current (repetitive) <sup>4)</sup>	200	$\text{A}/\mu\text{s}$
	Critical rate of rise of on-state current (non-repetitive) <sup>4)</sup>	400	$\text{A}/\mu\text{s}$
$V_{RGM}$	Peak reverse gate voltage	5	V
$P_{G(AV)}$	Mean forward gate power	4	W
$P_{GM}$	Peak forward gate power	40	W
$V_{ISOL}$	Isolation Voltage <sup>5)</sup>	3000	V
$T_{vj\ op}$	Operating temperature range	-40 - +125	$^\circ\text{C}$
$T_{stg}$	Storage temperature range	-40 - +125	$^\circ\text{C}$

#### Notes:

- De-rating factor of 0.13% per  $^\circ\text{C}$  is applicable for  $T_{vj}$  below  $25^\circ\text{C}$ .
- Single phase; 50 Hz,  $180^\circ$  half-sinewave.
- Half-sinewave,  $125^\circ\text{C}$   $T_{vj}$  initial.
- $V_D = 67\% V_{DRM}$ ,  $I_{FG} = 2$  A,  $t_r \leq 0.5\mu\text{s}$ ,  $T_C = 125^\circ\text{C}$ .
- AC RMS voltage, 50 Hz, 1min test

**Characteristics**

	PARAMETER	MIN.	TYP.	MAX.	TEST CONDITIONS <sup>1)</sup>	UNITS
$V_{TM}$	Maximum peak on-state voltage	-	-	1.29	$I_{TM} = 500A, T_{vj} = T_{vjMAX}$	V
$V_{TM}$	Maximum peak on-state voltage	-	-	1.71	$I_{TM} = 1500A, T_{vj} = T_{vjMAX}$	V
$V_{T0}$	Threshold voltage	-	-	1.079		V
$r_T$	Slope resistance	-	-	0.422		m $\Omega$
$(dv/dt)_{cr}$	Critical rate of rise of off-state voltage	1000	-	-	$V_D = 0.67\% V_{DRM}, \text{Gate o/c}$	V/ $\mu$ s
$I_{DRM}$	Peak off-state current	-	-	250	Rated $V_{DRM}$	mA
$I_{RRM}$	Peak reverse current	-	-	250	Rated $V_{RRM}$	mA
$V_{GT}$	Gate trigger voltage	-	-	2.5	$T_{vj} = 25^\circ\text{C}, V_D = 12\text{ V}, I_T = 3\text{ A}$	V
$I_{GT}$	Gate trigger current	-	-	250		mA
$V_{GD}$	Gate non-trigger voltage	0.35	-	-	$67\% V_{DRM}$	V
$I_H$	Holding current	-	-	300	$V_D = 12\text{ V}, T_{vj} = 25^\circ\text{C}$	mA
$t_{gd}$	Gate controlled turn-on delay time	-	3.00	-	$I_{FG} = 2\text{ A}, t_r = 0.5\ \mu\text{s}, V_D = 40\%V_{DRM}, I_{TM} = 800A, di/dt = 10\text{ A}/\mu\text{s}, T_{vj} = 25^\circ\text{C}$	$\mu$ s
$t_{gt}$	Turn-on time	-	4.5	-		$\mu$ s
$Q_{rr}$	Recovered Charge	-	-	3300	$I_{TM} = 500A, di/dt = 5A/\mu\text{s}, V_R = 100\text{ V}$	$\mu$ C
$Q_{ra}$	Recovered Charge, 50% chord	-	-	3000		$\mu$ C
$I_{rm}$	Reverse recovery current	-	-	120		A
$t_{rr}$	Reverse recovery time, 50% chord	-	-	50		$\mu$ s
$t_q$	Turn-off time	-	-	400	$I_{TM} = 500A, di/dt = 10\text{ A}/\mu\text{s}, V_R = 100\text{ V}, V_{DR} = 67\%V_{DRM}, dv_{DR}/dt = 50\text{ V}/\mu\text{s}$	$\mu$ s
$R_{thJC}$	Thermal resistance, junction to case	-	-	0.050	Single Thyristor	K/W
		-	-	0.025	Whole Module	K/W
$R_{thCH}$	Thermal resistance, case to heatsink	-	-	0.016	Single Thyristor	K/W
		-	-	0.008	Whole Module	K/W
$F_1$	Mounting force (to heatsink)		-	9.00	<sup>2)</sup>	Nm
$F_2$	Mounting force (to terminals)		-	18.00		Nm
$W_t$	Weight	-	3.5	-		kg

**Notes:**

- 1) Unless otherwise indicated  $T_{vj}=125^\circ\text{C}$ .
- 2) Screws must be lubricated.

## Notes on Ratings and Characteristics

### 1.0 Voltage Grade Table

Voltage Grade	$V_{DRM}$ $V_{RRM}$ V	$V_{DSM}$ $V_{RSM}$ V	$V_D$ $V_R$ DC V
30	3000	3100	1750
36	3600	3700	1900

### 2.0 Extension of Voltage Grades

This report is applicable to other voltage grades when supply has been agreed by Sales/Production.

### 3.0 De-rating Factor

A blocking voltage de-rating factor of 0.13%/°C is applicable to this device for  $T_{vj}$  below 25°C.

### 4.0 Repetitive dv/dt

Standard dv/dt is 1000V/μs.

### 5.0 Snubber Components

When selecting snubber components, care must be taken not to use excessively large values of snubber capacitor or excessively small values of snubber resistor. Such excessive component values may lead to device damage due to the large resultant values of snubber discharge current. If required, please consult the factory for assistance.

### 6.0 Rate of rise of on-state current

The maximum un-primed rate of rise of on-state current must not exceed 400A/μs at any time during turn-on on a non-repetitive basis. For repetitive performance, the on-state rate of rise of current must not exceed 200A/μs at any time during turn-on. Note that these values of rate of rise of current apply to the total device current including that from any local snubber network.

### 7.0 Gate Drive

The nominal requirement for a typical gate drive is illustrated below. An open circuit voltage of at least 30V is assumed. This gate drive must be applied when using the full di/dt capability of the device.

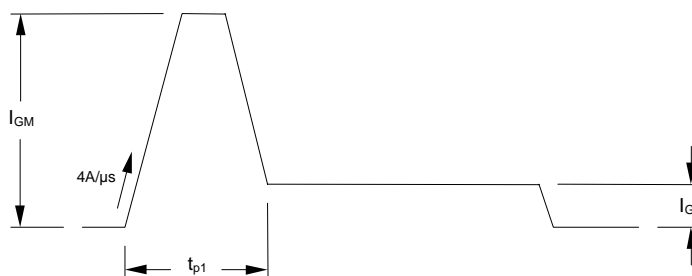

The magnitude of  $I_{GM}$  should be between five and ten times  $I_{GT}$ , which is shown on page 2. Its duration ( $t_{p1}$ ) should be 20μs or sufficient to allow the anode current to reach ten times  $I_L$ , whichever is greater. Otherwise, an increase in pulse current could be needed to supply the necessary charge to trigger. The 'back-porch' current  $I_G$  should remain flowing for the same duration as the anode current and have a magnitude in the order of 1.5 times  $I_{GT}$ .

## 8.0 Computer Modelling Parameters

### 8.1 Thyristor Dissipation Calculations

$$I_{AV} = \frac{-V_{T0} + \sqrt{V_{T0}^2 + 4 \cdot ff^2 \cdot r_T \cdot W_{AV}}}{2 \cdot ff^2 \cdot r_T} \quad \text{and:} \quad W_{AV} = \frac{\Delta T}{R_{th}}$$

$$\Delta T = T_{j \max} - T_K$$

Where  $V_{T0} = 1.079 \text{ V}$ ,  $r_T = 0.422 \text{ m}\Omega$ .

$R_{th}$  = Supplementary thermal impedance, see table below and

$ff$  = Form factor, see table below.

Supplementary Thermal Impedance							
Conduction Angle	30°	60°	90°	120°	180°	270°	d.c.
Square wave	0.0595	0.0561	0.0547	0.0537	0.0525	0.0511	0.0500
Sine wave	0.0536	0.0527	0.0522	0.0518	0.0500		

Form Factors							
Conduction Angle	30°	60°	90°	120°	180°	270°	d.c.
Square wave	3.464	2.449	2	1.732	1.414	1.149	1
Sine wave	3.98	2.778	2.22	1.879	1.57		

### 8.2 Calculating thyristor $V_T$ using ABCD Coefficients

The on-state characteristic  $I_T$  vs.  $V_T$ , on page 6 is represented by a set of constants A, B, C, D, forming the coefficients of the representative equation for  $V_T$  in terms of  $I_T$  given below:

$$V_T = A + B \cdot \ln(I_T) + C \cdot I_T + D \cdot \sqrt{I_T}$$

The constants, derived by curve fitting software, are given below for both hot and cold characteristics. The resulting values for  $V_T$  agree with the true device characteristic over a current range, which is limited to that plotted.

25°C Coefficients		125°C Coefficients	
A	1.113312E+00	A	9.469148E-01
B	4.149038E-02	B	1.031913E-02
C	3.240304E-04	C	3.254697E-04
D	-1.954991E-03	D	5.185360E-03

## 8.3 D.C. Thermal Impedance Calculation

$$r_t = \sum_{p=1}^{p=n} r_p \cdot \left( 1 - e^{-\frac{t}{\tau_p}} \right)$$

Where  $p = 1$  to  $n$  and:

- $n$  = number of terms in the series
- $t$  = Duration of heating pulse in seconds
- $r_t$  = Thermal resistance at time  $t$
- $r_p$  = Amplitude of  $p_{th}$  term
- $\tau_p$  = Time Constant of  $r_{th}$  term

The coefficients for this device are shown in the table below:

D.C.						
Term	1	2	3	4	5	6
$r_p$	0.02506	0.009643	0.00348	0.009712	0.001719	0.0004399
$\tau_p$	8.474	1.110	0.2289	0.04529	0.009524	0.0002414

## 9.0 Reverse recovery ratings

(i)  $Q_{ra}$  is based on 50%  $I_{RM}$  chord as shown in Fig. 1

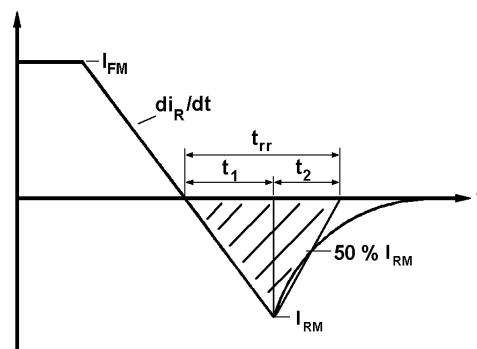

Fig. 1

(ii)  $Q_{rr}$  is based on a  $150 \mu s$  integration time i.e.

$$Q_{rr} = \int_0^{150 \mu s} i_{rr} \cdot dt$$

(iii)

$$K \text{ Factor} = \frac{t_1}{t_2}$$

**Curves**

Figure 1 – On-state characteristics of Limit device

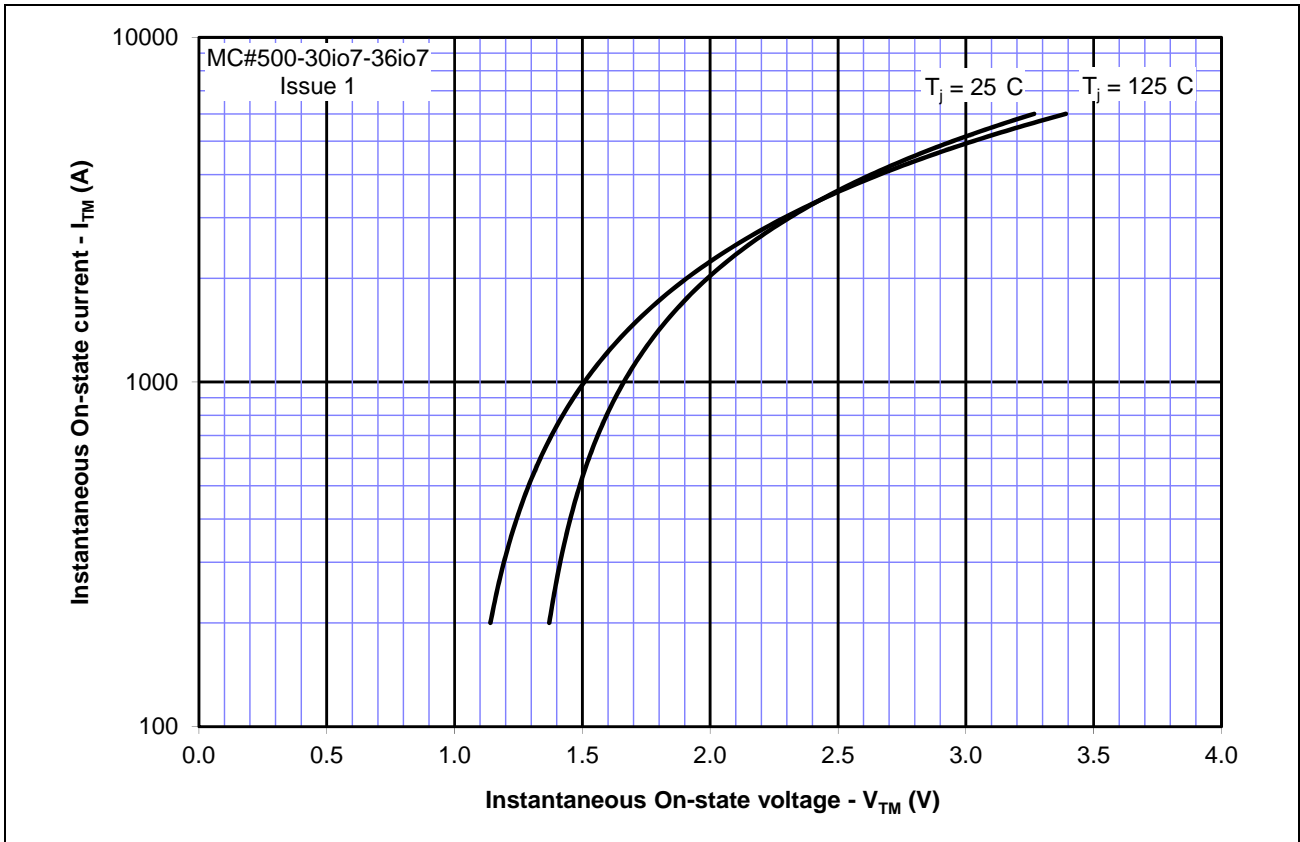

Figure 2 – Gate characteristics – Trigger limits

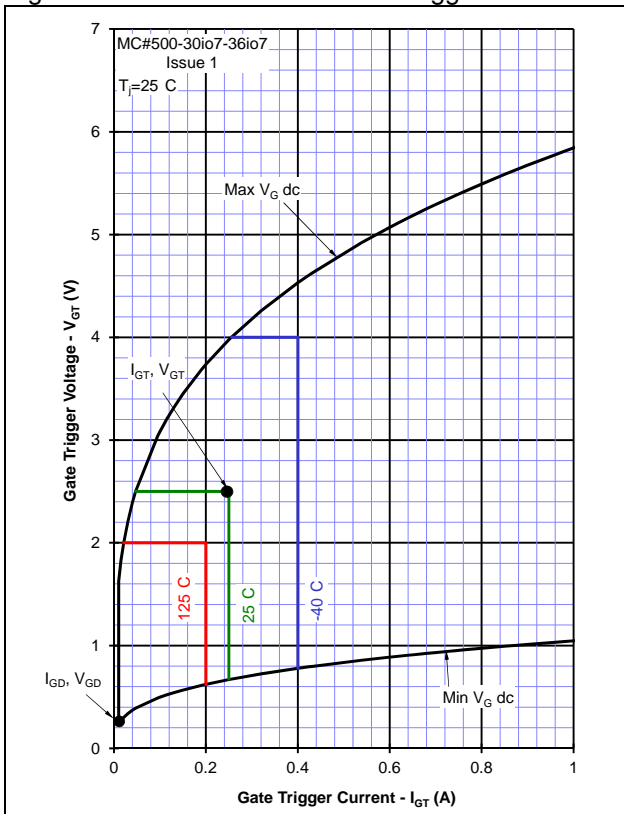

Figure 3 – Gate characteristics – Power curves

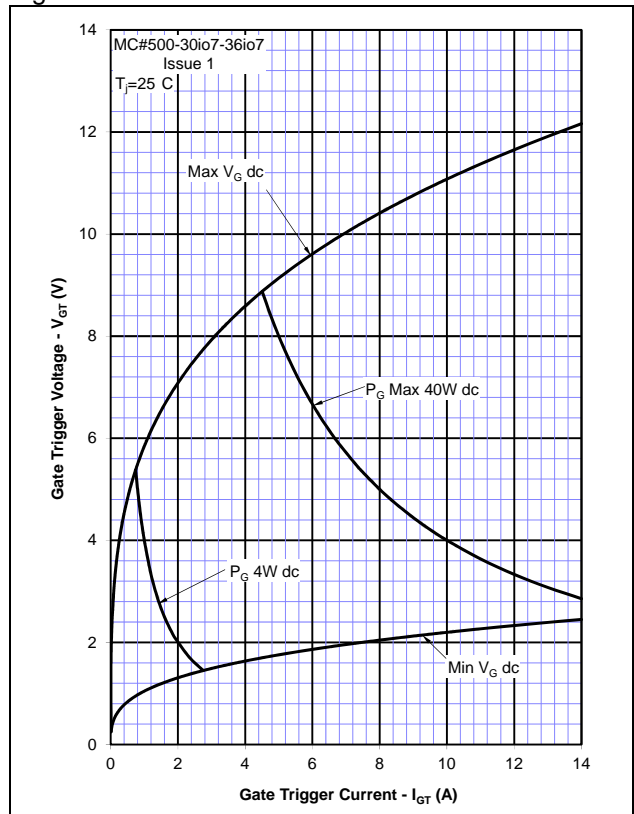

Figure 4 – Recovered Charge,  $Q_{rr}$

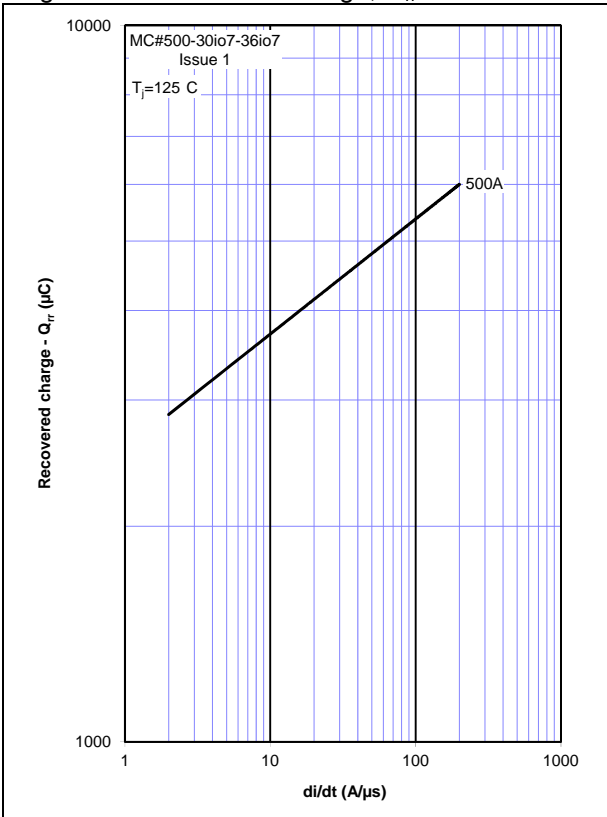

Figure 5 – Recovered charge,  $Q_{ra}$  (50% Chord)

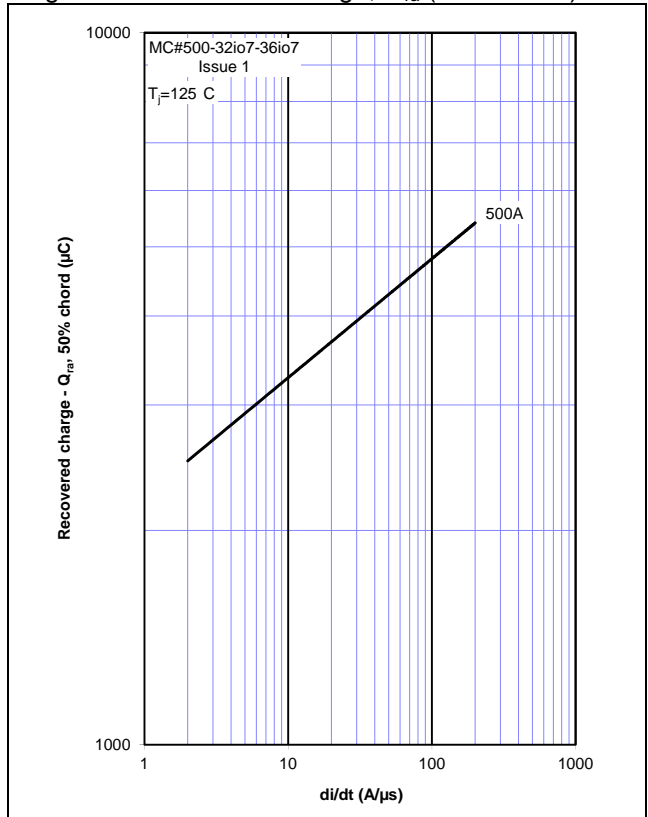

Figure 6 – Reverse recovery current,  $I_{rm}$

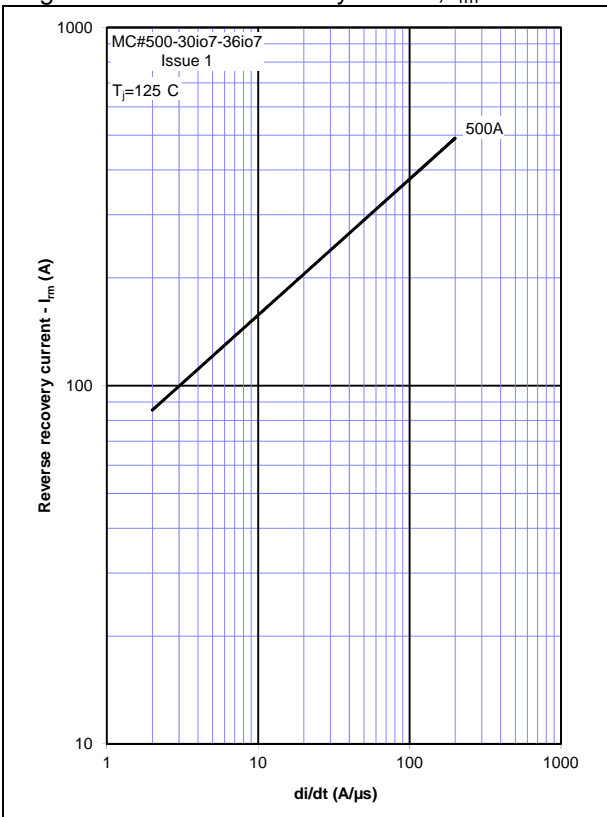

Figure 7 – Reverse recovery time,  $t_{rr}$

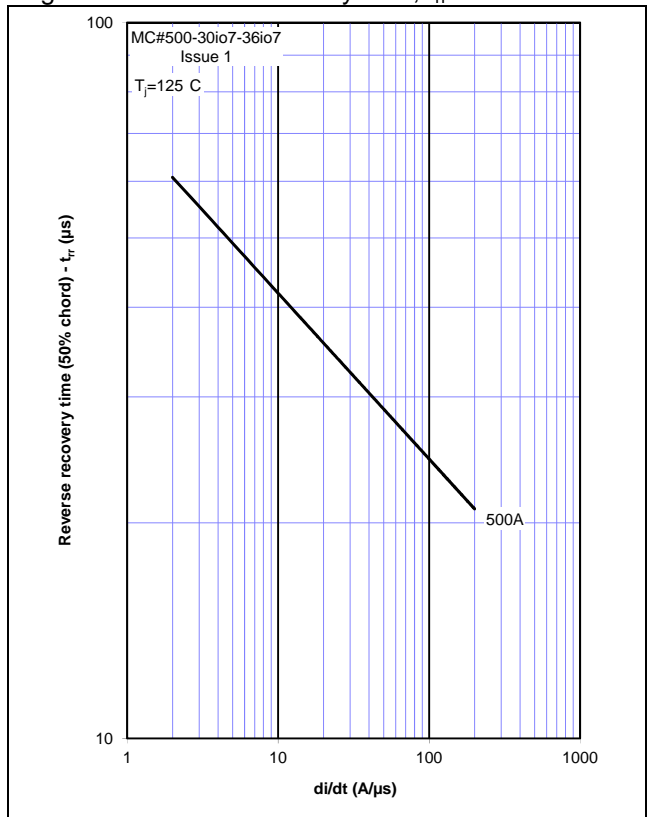

Figure 8 – On-state current vs. Power dissipation – Sine wave

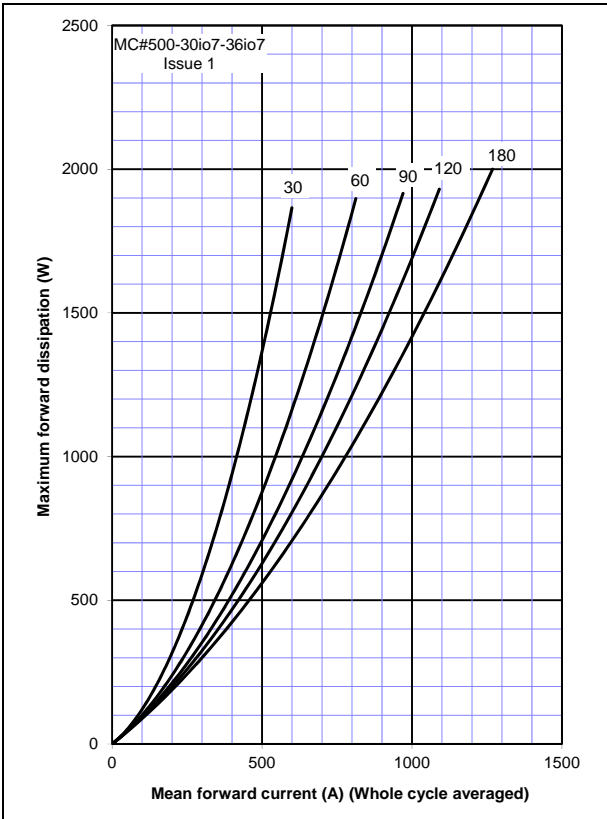

Figure 9 – On-state current vs. case temperature – Sine wave

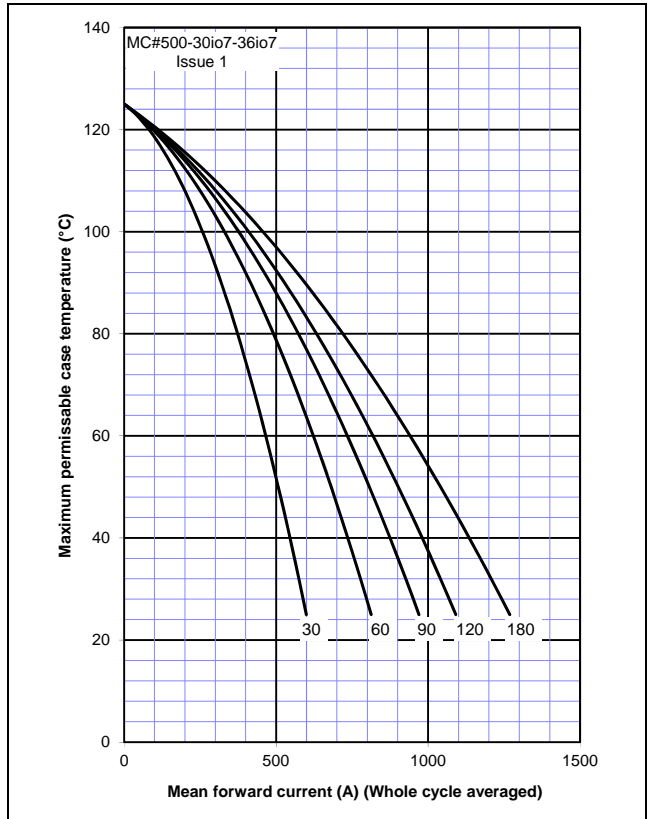

Figure 10 – On-state current vs. Power dissipation – Square wave

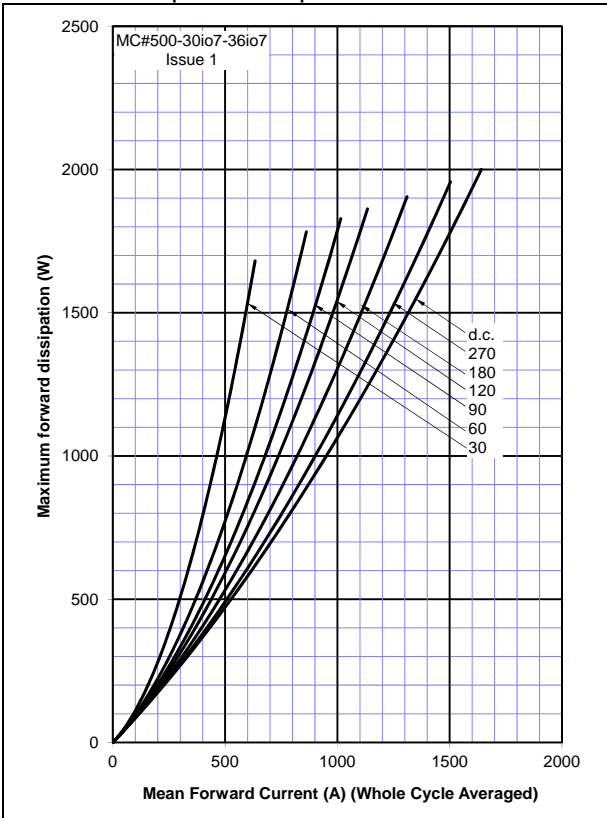

Figure 11 – On-state current vs. case temperature – Square wave

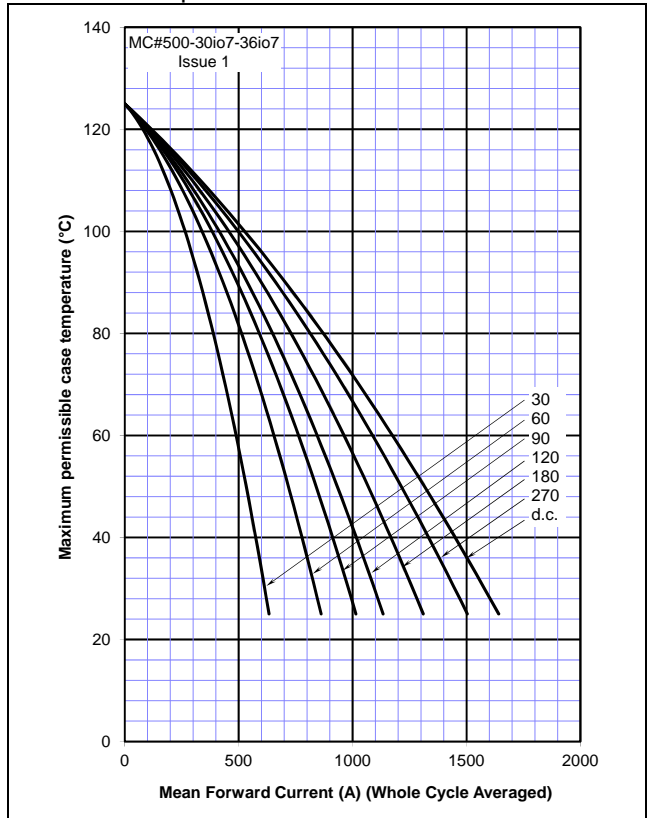



Figure 12 – Maximum surge and I<sup>2</sup>t Ratings

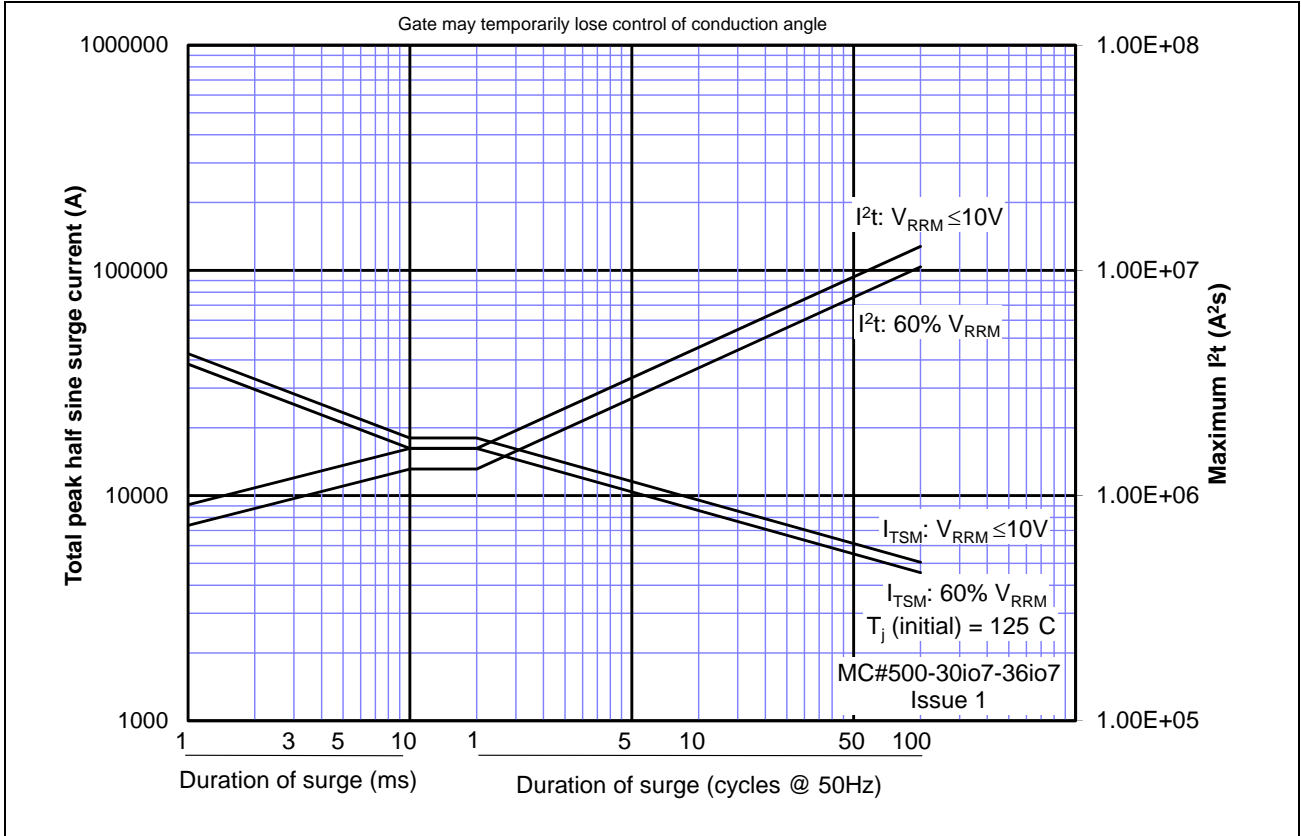
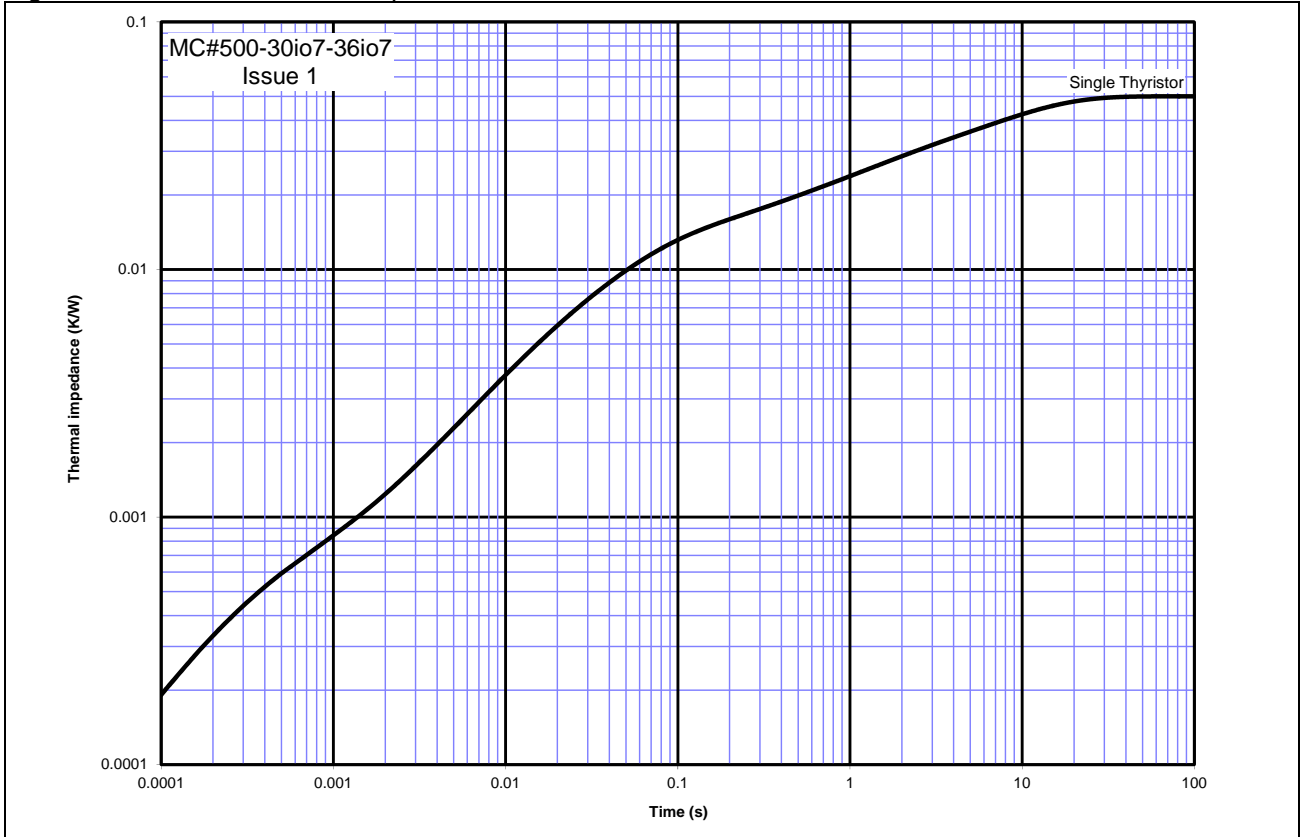
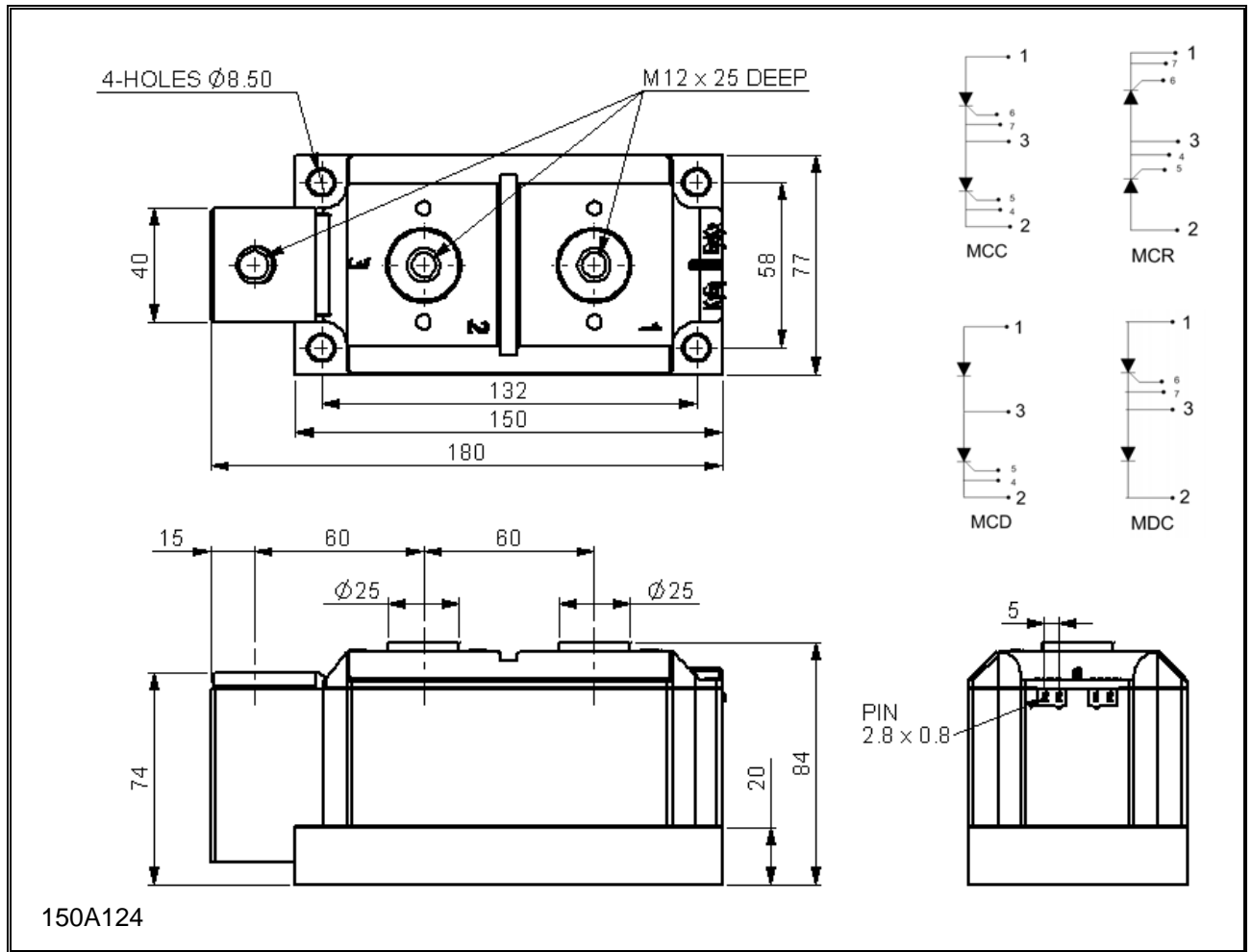

Figure 13 – Transient thermal impedance



Outline Drawing & Ordering Information



ORDERING INFORMATION					
(Please quote 11 digit code as below)					
<b>M</b>	<b>C#</b>	<b>500</b>	<b>◆◆</b>	<b>io</b>	<b>7</b>
Fixed Type Code	Configuration code CC, CD or DC	Fixed Type Code	Voltage code $V_{RRM}/100$ 30-36	i = Critical dv/dt 1000 V/μs o = Typical turn-off time	Fixed Version Code

Typical order code: MCC500-30io7 – MCC configuration, 3000V  $V_{RRM}$

**IXYS Semiconductor GmbH**  
 Edisonstraße 15  
 D-68623 Lampertheim  
 Tel: +49 6206 503-0  
 Fax: +49 6206 503-627  
 E-mail: [marcom@ixys.de](mailto:marcom@ixys.de)



[www.ixys.com](http://www.ixys.com)



[www.ixysuk.com](http://www.ixysuk.com)

**IXYS UK Westcode Ltd**  
 Langley Park Way, Langley Park,  
 Chippenham, Wiltshire, SN15 1GE.  
 Tel: +44 (0)1249 444524  
 Fax: +44 (0)1249 659448  
 E-mail: [sales@ixysuk.com](mailto:sales@ixysuk.com)

**IXYS Long Beach, Inc**  
 2500 Mira Mar Ave, Long Beach  
 CA 90815  
 Tel: +1 (562) 296 6584  
 Fax: +1 (562) 296 6585  
 E-mail: [service@ixyslongbeach.com](mailto:service@ixyslongbeach.com)

The information contained herein is confidential and is protected by Copyright. The information may not be used or disclosed except with the written permission of and in the manner permitted by the proprietors IXYS Semiconductors GmbH.  
 In the interest of product improvement, IXYS reserves the right to change specifications at any time without prior notice.

© IXYS Semiconductor GmbH.