

**GENERAL  
INSTRUMENT**

**DUAL VERY HIGH-SPEED  
LOGIC GATE OPTOCOUPPLERS**

Optocouplers

**MCL2630 (HCPL-2630)  
DUAL 10 MBit/s LOGIC GATE MCL2631 (HCPL-2631)**

**PACKAGE DIMENSIONS**

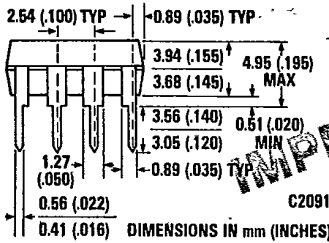
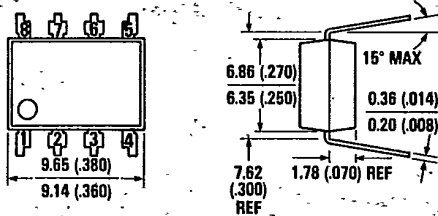

**IMPROVED!  
NOISE SHIELD**

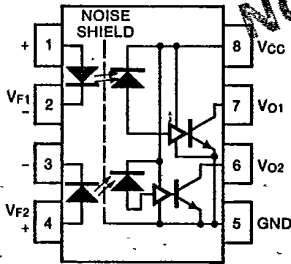

Equivalent Circuit

A 0.1 μF bypass capacitor must be connected between pins 8 and 5. (See note 1)

**DESCRIPTION**

The MCL/HCPL-2630 and MCL/HCPL-2631 dual channel optocouplers have two channels, each consisting of a 700 nm GaAsP LED, optically coupled to a very high speed integrated photodetector logic gate. The outputs feature open collectors, thereby permitting wired-OR outputs. The coupled parameters are guaranteed over the temperature range of 0-70° C. A maximum input signal of 5 mA will provide a minimum output sink current of 13 mA (fan-out of 8).

An internal noise shield provides superior common mode rejection of typically 10 kV/μs. The MCL/HCPL 2631 has a minimum CMR of 1 kV/μs.

An improved double-molded package allows superior insulation, permitting a 480 V working voltage compared to industry standard 220 V.

**FEATURES**

- Very high speed — 10 MBit/s
- Superior CMR — 10 kV/μs
- Superior insulation — 2500 V RMS 1 min.
- Double working voltage — 480 V
- Fan-out of 8 over 0-70° C
- Logic gate output
- Wired-OR — open collector
- U.L. recognized (File #E50151)

**APPLICATIONS**

- Ground loop elimination
- LSTTL to TTL, LSTTL or 5-volt CMOS
- Line receiver, data transmission
- Data multiplexing
- Switching power supplies
- Pulse transformer replacement
- Computer-peripheral interface

**ABSOLUTE MAXIMUM RATINGS**

Storage temperature ..... -55° C to + 125° C  
 Operating temperature ..... 0° C to + 70° C  
 Lead solder temperature ..... 260° C for 10 s  
 DC/Average forward input current (each channel) ..... 15 mA  
 Peak forward input current (each channel) ..... 30 mA (≤ 1 msec duration)

Reverse input voltage (each channel) ..... 5.0 V  
 Reverse supply voltage (-V<sub>cc</sub>) ..... -500 mV  
 Supply voltage, (V<sub>cc</sub>) ... 7.0 V/1 minute maximum  
 Output current, (I<sub>o</sub>) (each channel) ..... 16 mA  
 Output voltage, (V<sub>o</sub>) (each channel) ..... 7.0 V  
 Collector output power dissipation ..... 60 mW

# MCL2630 (HCPL-2630) MGL2631 (HCPL-2631)

GENL INSTR, OPTOELEK

88 DE 3890128 0002930 4

T-41-85

## RECOMMENDED OPERATING CONDITIONS

	SYMBOL	MIN.	MAX.	UNITS
Input current, low level	I <sub>FL</sub>	0	250	μA
Input current, high level	I <sub>FH</sub>	6.3*	15	mA
Supply voltage, output	V <sub>CC</sub>	4.5	5.5	V
Operating temperature	T <sub>A</sub>	0	70	°C
Fan out (TTL Load)	N		8	

\*6.3 mA is a guard banded value which allows for at least 20% CTR degradation. Initial input current threshold value is 5.0 mA or less.

## ELECTRICAL CHARACTERISTICS (T<sub>A</sub> = 0°C - 70°C Unless Otherwise Specified)

PARAMETER	SYMBOL	MIN.	TYP.	MAX.	UNITS	TEST CONDITIONS
High level output current	I <sub>OH</sub>		2	250	μA	V <sub>CC</sub> = 5.5 V, V <sub>O</sub> = 5.5 V I <sub>F</sub> = 250 μA, Note 6
Low level output voltage	V <sub>OL</sub>		0.34	0.6	V	V <sub>CC</sub> = 5.5 V, I <sub>F</sub> = 5 mA Note 6, I <sub>OL</sub> = 13 mA
High level supply current	I <sub>CCH</sub>		14	30	mA	V <sub>CC</sub> = 5.5 V, I <sub>F</sub> = 0 mA (Both channels)
Low level supply current	I <sub>CCL</sub>		26	36	mA	V <sub>CC</sub> = 5.5 V, I <sub>F</sub> = 10 mA (Both channels)
Input forward voltage	V <sub>F</sub>		1.55	1.75	V	I <sub>F</sub> = 10 mA, T <sub>A</sub> = 25°C
Input reverse breakdown voltage	B <sub>VR</sub>	5.0			V	I <sub>R</sub> = 10 μA, T <sub>A</sub> = 25°C
Input capacitance	C <sub>IN</sub>		60		pF	V <sub>F</sub> = 0, f = 1 MHz
Input diode temperature coefficient	ΔV <sub>F</sub> /ΔT <sub>A</sub>		-1.4		mV/°C	I <sub>F</sub> = 10 mA
Input-input insulation leakage current	I <sub>I-I</sub>		0.005		μA	Relative humidity = 45% t = 5 s, V <sub>I-I</sub> = 500 V, Note 7
Resistance (input-input)	R <sub>I-I</sub>		10 <sup>11</sup>		Ω	V <sub>I-I</sub> = 500 V, Note 7
Capacitance (input-input)	C <sub>I-I</sub>		0.25		pF	f = 1 MHz, Note 7
Input-output insulation leakage current	I <sub>I-O</sub>			1.0	μA	Relative humidity = 45% T <sub>A</sub> = 25°C, t = 5 s V <sub>I-O</sub> = 3000 V dc Note 10
Resistance (input to output)	R <sub>I-O</sub>		10 <sup>12</sup>		Ω	V <sub>I-O</sub> = 500 V, Note 10
Capacitance (input to output)	C <sub>I-O</sub>		0.6		pF	f = 1 MHz, Note 10
Withstand insulation test voltage	V <sub>ISO</sub>	2500			V <sub>RMS</sub>	RH < 50% T <sub>A</sub> = 25°C t = 1 min

\*All typical values are at V<sub>CC</sub> = 5 V, T<sub>A</sub> 25°C (each channel).

## SWITCHING CHARACTERISTICS (T<sub>A</sub> = 25°C, V<sub>CC</sub> = 5.0 V Unless Otherwise Specified)

PARAMETER	SYMBOL	DEVICE	MIN.	TYP.	MAX.	UNITS	TEST CONDITIONS
Propagation delay time (For output high level)	t <sub>PLH</sub>			48	75	ns	
Propagation delay time (For output low level)	t <sub>PHL</sub>			48	75	ns	R <sub>L</sub> = 350 Ω C <sub>L</sub> = 15 pF
Output rise time (10-90%)	t <sub>r</sub>			30		ns	I <sub>F</sub> = 7.5 mA
Output fall time (90-10%)	t <sub>f</sub>			14		ns	Notes, 2, 3, 4 & 5, Fig. 8
Common mode transient immunity (At output high level)	C <sub>MH</sub>	2631 2630	1000	10,000 10,000		V/μs	V <sub>CM</sub> = 50 V (peak) I <sub>F</sub> = 0 mA, V <sub>OL</sub> (min) = 2.0 V R <sub>L</sub> = 350 Ω, Note 9, Fig. 12
Common mode transient immunity (At output low level)	C <sub>ML</sub>	2631 2630	-1000	-10,000 -10,000		V/μs	V <sub>CM</sub> = 50 V (peak) I <sub>F</sub> = 7.5 mA, V <sub>OL</sub> (max) = 0.8 V R <sub>L</sub> = 350 Ω, Note 8, Fig. 12

**MCL2630 (HCPL-2630) MCL2631 (HCPL-2631)**

3890128 GENL INSTR, OPTOELEK

88D 02931 DT-41-85

**TYPICAL CHARACTERISTIC CURVES** ( $T_A = 25^\circ\text{C}$  Unless Otherwise Specified)

Optocouplers

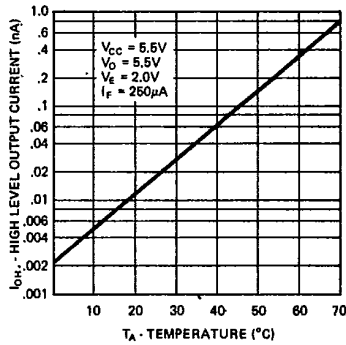

C1613

Fig. 2. High Level Output Current vs. Temperature

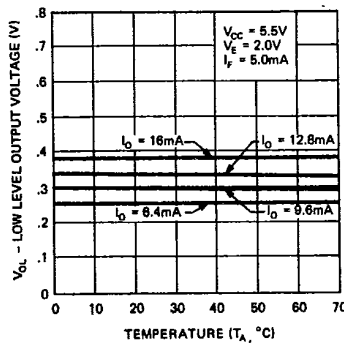

C1598

Fig. 3. Low Level Output Voltage vs. Temperature

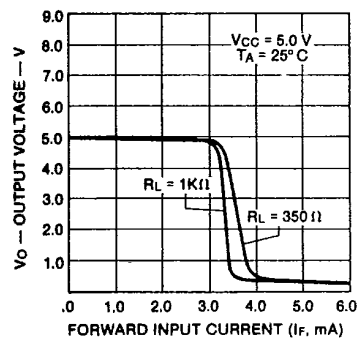

C1602

Fig. 4. Output Voltage vs. Forward Input Current

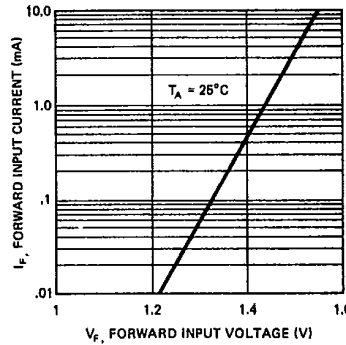

C1600

Fig. 5. Forward Input Current vs. Forward Input Voltage

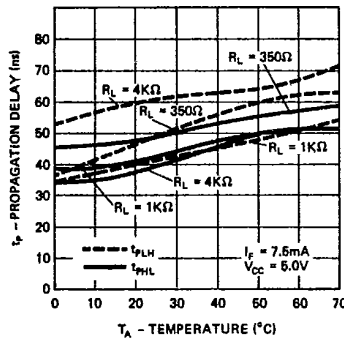

C1604

Fig. 6. Propagation Delay vs. Temperature

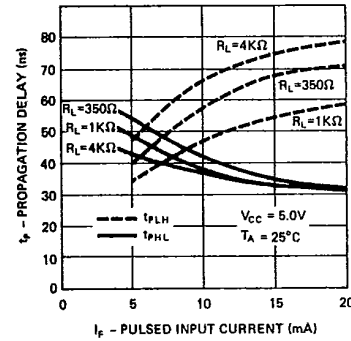

C1603

Fig. 7. Propagation Delay vs. Pulsed Input Current

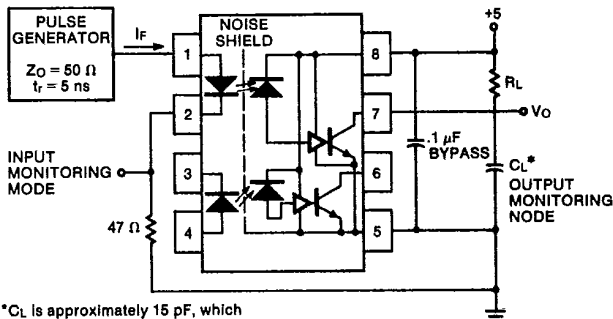

\*C<sub>L</sub> is approximately 15 pF, which includes probe and stray wiring capacitance

C1980

Fig. 8. Test CircuitZ  $t_{pLH}$ ,  $t_{pHL}$ ,  $t_r$ , and  $t_f$

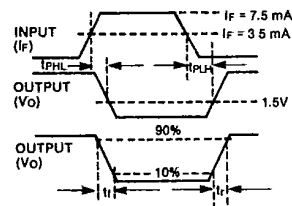

C1790

# MCL2630 (HCPL-2630) MCL2631 (HCPL-2631)

GENL INSTR, OPTOELEK

88 DE 3890128 0002932 8

T-41-85

## TYPICAL CHARACTERISTIC CURVES (T<sub>A</sub> = 25°C Unless Otherwise Specified)

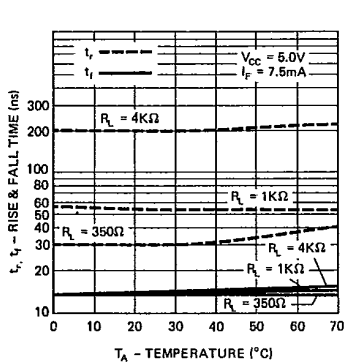

Fig. 9. Rise and Fall Time vs. Temperature

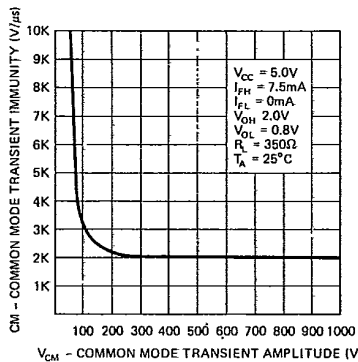

Fig. 10. Relative Common Mode Transient Immunity vs. Common Mode Transient Amplitude

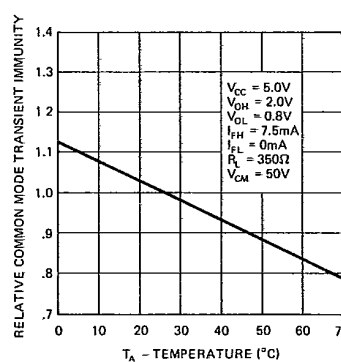

Fig. 11. Relative Common Mode Transient Immunity vs. Temperature

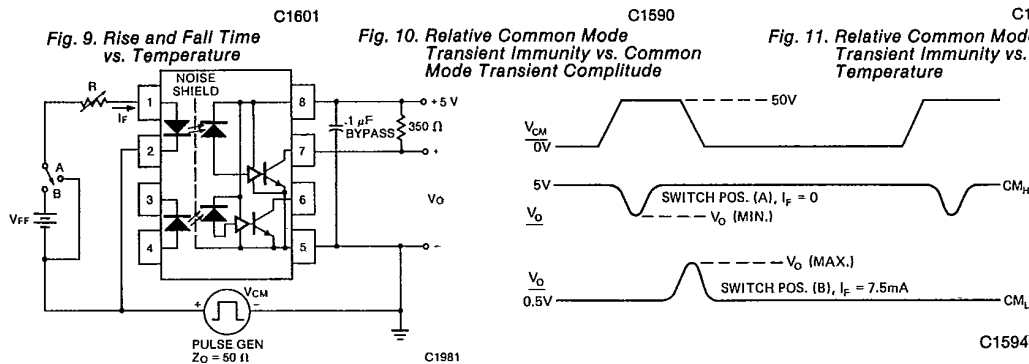

Fig. 12. Test Circuit for Transient Immunity and Typical Waveforms

### NOTES:

1. The V<sub>CC</sub> supply voltage to each MCL2630 isolator must be bypassed by a 0.1 μF capacitor or larger. This can be either a ceramic or solid tantalum capacitor with good high frequency characteristic and should be connected as close as possible to the package V<sub>CC</sub> and GND pins of each device.
2. t<sub>PHL</sub> - Propagation delay is measured from the 3.75 mA level on the LOW to HIGH transition of the input current pulse to the 1.5 V level on the HIGH to LOW transition of the output voltage pulse.
3. t<sub>PLH</sub> - Propagation delay is measured from the 3.75 mA level on the HIGH to LOW transition of the input current pulse to the 1.5 V level on the Low to High transition of the output voltage pulse.
4. t<sub>f</sub> - Fall time is measured from the 10% to the 90% levels of the HIGH to LOW transition on the output pulse.
5. t<sub>r</sub> - Rise time is measured from the 90% to the 10% levels of the LOW to HIGH transition on the output pulse.
6. Each channel.
7. Measured between pins 1 and 2 shorted together, and pins 3 and 4 shorted together.
8. CM<sub>L</sub> - The maximum tolerable rate of fall of the common mode voltage to ensure the output will remain in the low output state (i.e., V<sub>OUT</sub> > 0.8 V). Measured in volts per microsecond (V/μs).
9. CM<sub>H</sub> - The maximum tolerable rate of rise of the common mode voltage to ensure the output will remain in the high state (i.e., V<sub>OUT</sub> > 2.0 V). Measured in volts per microsecond (V/μs).

Volts/microsecond can be translated to sinusoidal voltages:

$$V/\mu s = \frac{(dV_{CM})}{dt} \text{ Max.} = \pi f_{CM} V_{CM} \text{ (P-P)}$$

Example: V<sub>CM</sub> = 318 V<sub>pp</sub> when f<sub>CM</sub> = 1 MHz using CM<sub>L</sub> and CM<sub>H</sub> = 1000 V/μs.

10. -Device considered a two-terminal device: Pins 1, 2, 3 and 4 shorted together, and Pins 5, 6, 7 and 8 shorted together.