



MOTOROLA

**MCM2115A
MCM21L15A
MCM2125A
MCM21L25A**

1024 x 1 STATIC RAM

The MCM2115A and MCM2125A families are high-speed, 1024 words by one-bit, random-access memories fabricated using HMOS, high-performance N-channel silicon-gate technology. Both open collector (MCM2115A) and three-state output (MCM2125A) are available. The devices use fully static circuitry throughout and require no clocks or timing strobes. Data out has the same polarity as the input data.

Access times are fully compatible with the industry-produced 1K Bipolar RAMs, yet offer up to 50% reduction in power over their Bipolar equivalents.

All inputs and output are directly TTL compatible. The chip select allows easy selection of an individual device when outputs are OR-tied.

- Organized as 1024 Words of 1 Bit
- Single +5 V Operation
- Maximum Access Time of 45 ns, 55 ns, and 70 ns available
- Low Operating Power Dissipation
- Pin Compatible to 93415A (2115A) and 93425A (2125A)
- TTL Inputs and Outputs
- Uncommitted Collector (2115A) and Three-State (2125A) Output

MOS

(N-CHANNEL, SILICON-GATE)

**1024-BIT STATIC
RANDOM ACCESS
MEMORY**

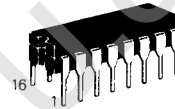

**C SUFFIX
FRIT-SEAL
CERAMIC PACKAGE
CASE 620**

BLOCK DIAGRAM

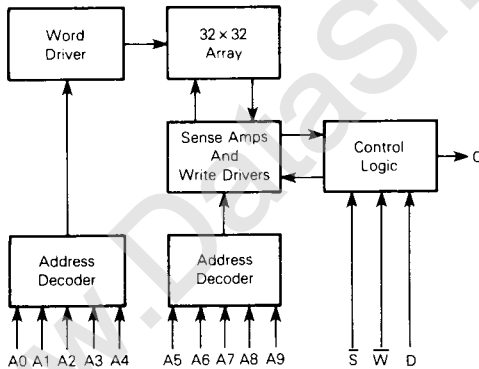

TRUTH TABLE

Inputs			Output 2115A Family	Output 2125A Family	Mode
S	W	D	Q	Q	
H	X	X	H	High Z	Not Selected
L	L	L	H	High Z	Write "0"
L	L	H	H	High Z	Write "1"
L	H	X	Data Out	Data Out	Read

PIN ASSIGNMENT

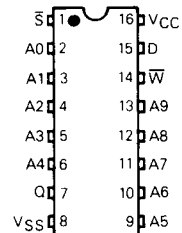

PIN NAMES

A	Address
D	Data Input
Q	Data Output
S	Chip Select
VCC	+5 V Supply
VSS	Ground
W	Write Enable

SRAM

MCM2115A•MCM21L15A•MCM2125A•MCM21L25A

ABSOLUTE MAXIMUM RATINGS (See Note)

Rating	Value	Unit
Temperature Under Bias	-10 to +80	°C
Voltage on Any Pin With Respect to V _{SS}	-0.5 to +7.0	Vdc
DC Output Current	20	mA
Power Dissipation	1.0	Watt
Operating Temperature Range	0 to +70	°C
Storage Temperature Range	-65 to +150	°C

This device contains circuitry to protect the inputs against damage due to high static voltages or electric fields; however, it is advised that normal precautions be taken to avoid application of any voltage higher than maximum rated voltages to this high-impedance circuit.

NOTE: Permanent damage may occur if ABSOLUTE MAXIMUM RATINGS are exceeded. Functional operation should be restricted to RECOMMENDED OPERATING CONDITIONS. Exposure to higher than recommended voltages for extended periods of time could affect device reliability.

DC OPERATING CONDITIONS AND CHARACTERISTICS (Full operating voltage and temperature range unless otherwise noted.)

RECOMMENDED DC OPERATING CONDITIONS

Parameter	Symbol	Min	Typ	Max	Unit
Supply Voltage	V _{CC} V _{SS}	4.75 0	5.0 0	5.25 0	V
Logic 1 Voltage, All Inputs	V _{IH}	2.1	-	6	V
Logic 0 Voltage, All Inputs	V _{IL}	-0.3	-	0.8	V

DC OPERATING CHARACTERISTICS

Parameter	Symbol	MCM2115A		MCM21L15A		MCM2125A		MCM21L25A		Unit
		Min	Max	Min	Max	Min	Max	Min	Max	
Input Low Current (All Input Pins, V _{IN} =0 to 5.5 V)	I _{IL}	-	-40	-	-40	-	-40	-	-40	μA
Input High Current	I _{IH}	-	40	-	40	-	40	-	40	μA
Output Leakage Current (V _{OUT} =0.5/2.4 V)	I _{OL}	-	-	-	-	-	50	-	50	μA
Output Leakage Current (V _{OUT} =4.5 V)	I _{CEX}	-	100	-	100	-	-	-	-	μA
Power Supply Current (S=V _{IL} , Outputs Open T _A =25°C)	I _{CC}	-	125	-	75	-	125	-	75	mA
Output Low Voltage (I _{OL} =7.0 mA, 2125A, 16 mA 2115A)	V _{OL}	-	0.45	-	0.45	-	0.45	-	0.45	V
Output High Voltage (I _{OH} =-4.0 mA)	V _{OH}	-	-	-	-	2.4	-	2.4	-	V
Current Short Circuit to Ground	I _{OS}	-	-	-	-	-	-100	-	-100	mA

MCM2115A FAMILY AC OPERATING CONDITIONS AND CHARACTERISTICS, READ, WRITE CYCLES

(T_A=0 to 70°C, V_{CC}=5.0 V ±5%)

Parameter	Symbol	MCM2115A-45		MCM2115A-55		MCM2115A-70		Units
		Min	Max	Min	Max	Min	Max	
Chip Select Low Output Valid	t _{SLQV}	5	30	5	35	5	40	ns
Chip Select High to Output Invalid	t _{SHOZ}	-	30	-	35	-	40	ns
Address Valid to Output Valid	t _{AVQV}	-	45	-	55	-	70	ns
Address Valid to Output Invalid	t _{AVQX}	10	-	10	-	10	-	ns
Write Low to Output Disable	t _{WLQZ}	-	30	-	35	-	40	ns
Write High to Output Valid	t _{WHQV}	0	30	0	35	0	45	ns
Write Low to Write High (Write Pulse Width)	t _{WLWH}	30	-	40	-	50	-	ns
Data Valid to Write Low	t _{DVWL}	5	-	5	-	5	-	ns
Write High to Data Don't Care (Data Hold)	t _{WHDX}	5	-	5	-	5	-	ns
Address Valid to Write Low (Address Setup)	t _{AVWL}	5	-	5	-	15	-	ns
Write High to Address Don't Care	t _{WHAX}	5	-	5	-	5	-	ns
Chip Select Low to Write Low	t _{SLWL}	5	-	5	-	5	-	ns
Write High to Chip Select High	t _{WHSH}	5	-	5	-	5	-	ns
Address Valid to Address Don't Care	t _{AVAX}	-	45	-	55	-	70	ns
Chip Select Low to Chip Select High	t _{SLSH}	-	45	-	55	-	70	ns

SRAM

MCM2115A•MCM21L15A•MCM2125A•MCM21L25A

MCM2115A FAMILY AC OPERATING CONDITIONS AND CHARACTERISTICS, READ, WRITE CYCLES
(T_A = 0 to 70°C, V_{CC} = 5.0 V ± 5%)

Parameter	Symbol	MCM2115A-45		MCM2115A-70		Units
		Min	Max	Min	Max	
Chip Select Low to Output Valid	t _{SLOV}	5	30	5	30	ns
Chip Select High to Output Invalid	t _{SHQZ}	—	30	—	30	ns
Address Valid to Output Valid	t _{AVQV}	—	45	—	70	ns
Address Valid to Output Invalid	t _{AVQX}	10	—	10	—	ns
Write Low to Output Disable	t _{WLOZ}	—	25	—	25	ns
Write High to Output Valid	t _{WHQV}	0	25	0	25	ns
Write Low to Write High (Write Pulse Width)	t _{WLWH}	30	—	30	—	ns
Data Valid to Write Low	t _{DVWL}	0	—	0	—	ns
Write High to Data Don't Care	t _{WHDX}	5	—	5	—	ns
Address Valid to Write Low (Address Setup)	t _{AVWL}	5	—	5	—	ns
Write High to Address Don't Care	t _{WHAX}	5	—	5	—	ns
Chip Select Low to Write Low	t _{SLWL}	5	—	5	—	ns
Write High to Chip Select High	t _{WHS}	5	—	5	—	ns
Address Valid to Address Don't Care	t _{AVAX}	—	45	—	70	ns
Chip Select Low to Chip Select High	t _{SLSH}	—	45	—	70	ns

MCM2125A FAMILY AC OPERATING CONDITIONS AND CHARACTERISTICS, READ, WRITE CYCLES
(T_A = 0 to 70°C, V_{CC} = 5.0 V ± 5%)

Parameter	Symbol	MCM2125A-45		MCM2125A-55		MCM2125A-70		Units
		Min	Max	Min	Max	Min	Max	
Chip Select Low to Output Valid	t _{SLOV}	5	30	5	35	5	40	ns
Chip Select High to Output High Z	t _{SHQZ}	—	30	—	35	—	40	ns
Address Valid to Output Valid	t _{AVQV}	—	45	—	55	—	70	ns
Address Valid to Output Invalid	t _{AVQX}	10	—	10	—	10	—	ns
Write Low to Output High Z	t _{WLOZ}	—	30	—	35	—	40	ns
Write High to Output Valid	t _{WHQV}	0	30	0	35	0	45	ns
Write Low to Write High (Write Pulse Width)	t _{WLWH}	30	—	40	—	50	—	ns
Data Valid to Write Low	t _{DVWL}	5	—	5	—	5	—	ns
Write High to Data Don't Care	t _{WHDX}	5	—	5	—	5	—	ns
Address Valid to Write Low (Address Setup)	t _{AVWL}	5	—	5	—	15	—	ns
Write High to Address Don't Care	t _{WHAX}	5	—	5	—	5	—	ns
Chip Select Low to Write Low	t _{SLWL}	5	—	5	—	5	—	ns
Write High to Chip Select High	t _{WHS}	5	—	5	—	5	—	ns
Address Valid to Address Don't Care	t _{AVAX}	—	45	—	55	—	70	ns
Chip Select Low to Chip Select High	t _{SLSH}	—	45	—	55	—	70	ns

MCM21L25A FAMILY AC OPERATING CONDITIONS AND CHARACTERISTICS, READ, WRITE CYCLES
(T_A = 0 to 70°C, V_{CC} = 5.0 V ± 5%)

Parameter	Symbol	MCM21L25A-45		MCM21L25A-70		Units
		Min	Max	Min	Max	
Chip Select Low to Output Valid	t _{SLOV}	5	30	5	30	ns
Chip Select High to Output High Z	t _{SHQZ}	—	30	—	30	ns
Address Valid to Output Valid	t _{AVQV}	—	45	—	70	ns
Address Valid to Output Invalid	t _{AVQX}	10	—	10	—	ns
Write Low to Output High Z	t _{WLOZ}	—	25	—	25	ns
Write High to Output Valid	t _{WHQV}	0	25	0	25	ns
Write Low to Write High (Write Pulse Width)	t _{WLWH}	30	—	30	—	ns
Data Valid to Write Low	t _{DVWL}	0	—	0	—	ns
Write High to Data Don't Care	t _{WHDX}	5	—	5	—	ns
Address Valid to Write Low (Address Setup)	t _{AVWL}	5	—	5	—	ns
Write High to Address Don't Care	t _{WHAX}	5	—	5	—	ns
Chip Select Low to Write Low	t _{SLWL}	5	—	5	—	ns
Write High to Chip Select High	t _{WHS}	5	—	5	—	ns
Address Valid to Address Don't Care	t _{AVAX}	—	45	—	70	ns
Chip Select Low to Chip Select High	t _{SLSH}	—	45	—	70	ns

CAPACITANCE ($f = 1.0 \text{ MHz}$, $T_A = 25^\circ\text{C}$, periodically sampled rather than 100% tested.)

Characteristic	Symbol	Max	Unit
Input Capacitance ($V_{in} = 0 \text{ V}$)	C_{in}	5	pF
Output Capacitance ($V_{out} = 0 \text{ V}$)	C_{out}	8	pF

Capacitance measured with a Boonton Meter or effective capacitance calculated from the equation: $C = I\Delta t / \Delta V$.

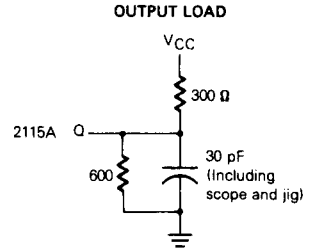

2115A FAMILY

READ CYCLE TIMING 1
(\bar{S} Held Low, \bar{W} Held High)

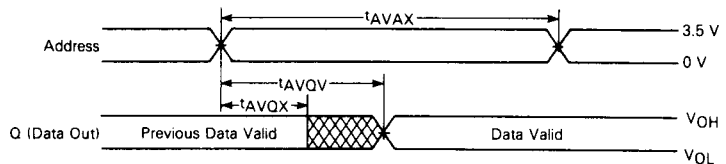

READ CYCLE TIMING 2
(\bar{W} Held High)

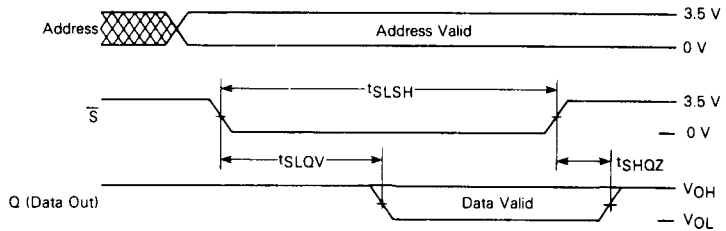

WRITE CYCLE TIMING

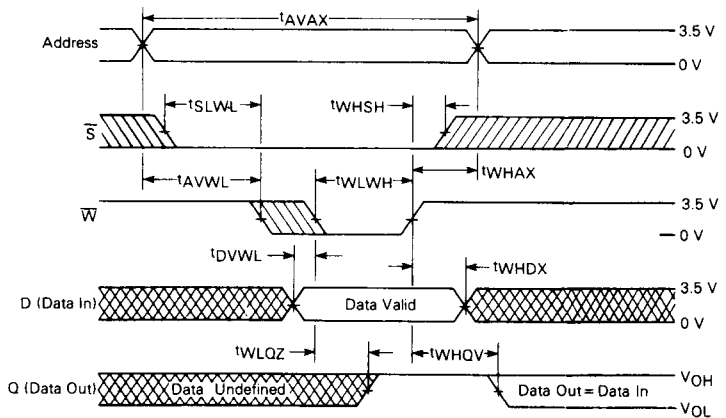

(All Time Measurements Referenced to 1.5 V)

SRAM

Waveform Symbol	Input	Output
	Must Be Valid	Will Be Valid
	Change From H to L	Will Change From H to L
	Change From L to H	Will Change From L to H
	Don't Care: Any Change Permitted	Changing State Unknown
	-	High Impedance

OUTPUT LOAD

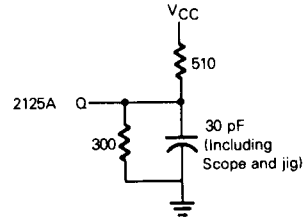

2125A FAMILY

READ CYCLE TIMING 1
(\bar{S} Held Low, \bar{W} Held High)

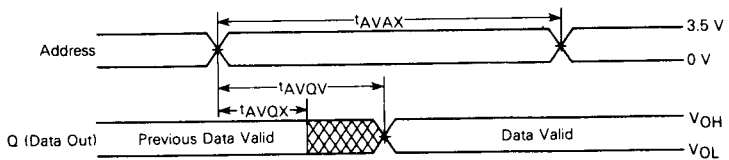

READ CYCLE TIMING 2
(\bar{W} Held High)

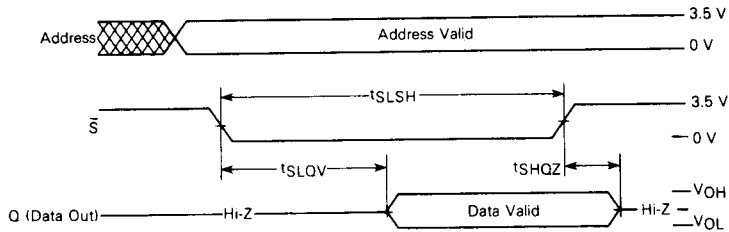

WRITE CYCLE TIMING

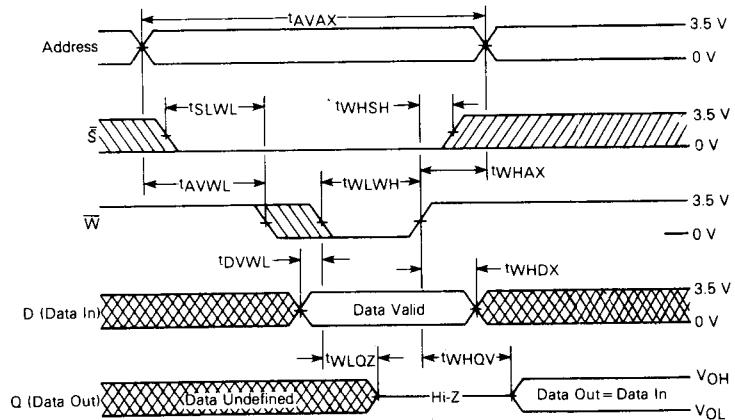

(All time measurements referenced to 1.5 V)

SRAM

2115A FAMILY

WRITE ENABLE TO HIGH-Z DELAY

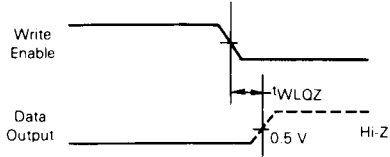

PROPAGATION DELAY FROM CHIP SELECT TO HIGH-Z

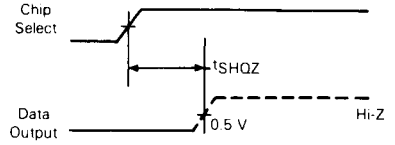

WRITE ENABLE TO HIGH-Z DELAY

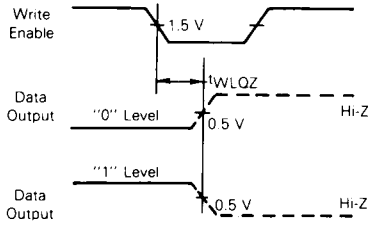

PROPAGATION DELAY FROM CHIP SELECT TO HIGH-Z

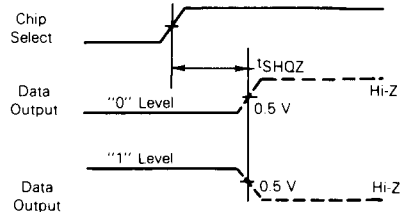

SRAM