

FEATURES

- Available as "HR" (high reliability) screened per MIL-PRF-19500, JANTX level. Add "HR" suffix to base part number.
- Available as non-RoHS (Sn/Pb plating), standard, and as RoHS by adding "-PBF" suffix.

MAXIMUM RATINGS

Rating	Symbol	Value		Unit
		MCR70	MCR71	
Repetitive peak forward or reverse blocking voltage ⁽¹⁾ MCR70 MCR71	V_{DRM}/V_{RRM}	1	25	Volts
		2	50	
		3	100	
Peak discharge current ⁽²⁾	I_{TM}	850	1700	Amps
On-state current ($T_C \leq 75^\circ\text{C}$)	$I_{T(RMS)}$	35	55	Amps
	$I_{T(AV)}$	22	35	
Peak non-repetitive surge current (1/2 cycle, sine wave, 60Hz, $T_J = 125^\circ\text{C}$)	I_{TSM}	350	550	Amps
Circuit fusing ($t = 8.3 \text{ ms}$)	I^2t	510	1255	A^2s
Critical rate of rise of current ⁽³⁾	di/dt	100	200	$\text{A}/\mu\text{s}$
Forward peak gate power ($t \leq 20\mu\text{s}$)	P_{GM}	20		Watts
Forward average gate power	$P_{G(AV)}$	0.5		Watts
Forward peak gate current ($t \leq 20\mu\text{s}$)	I_{GM}	2		Amps
Operating junction storage temperature range	T_J	-40 to +125		$^\circ\text{C}$
Storage temperature range	T_{stg}	-40 to +150		$^\circ\text{C}$
Mounting torque	-	30		In. lb.

- The rated voltage can be applied over the rated operating junction temperatures without incurring damage. Ratings apply for shorted-open or shorted-gate conditions or negative voltage on the gate. Devices should not be tested for blocking capability in a manner such that the voltage supplied exceeds the rated blocking voltages.
- Rating is for $t_w = 1\text{ms}$.
- Test conditions: $I_G = 150\text{mA}$, $V_D = \text{Rated } V_{DRM}$, $I_{TM} = \text{Rated value}$, $T_J = 125^\circ\text{C}$.

THERMAL CHARACTERISTICS

Characteristic	Symbol	Max	Unit
Thermal resistance, junction to case	$R_{\theta JC}$	1	$^\circ\text{C}/\text{W}$

ELECTRICAL CHARACTERISTICS ($T_J = 25^\circ\text{C}$ unless otherwise specified)

Characteristic	Symbol	Min	Typ	Max	Unit
Peak forward or reverse blocking current (rated V_{DRM} or V_{RRM}) ($T_J = 25^\circ\text{C}$) ($T_J = 125^\circ\text{C}$)	I_{DRM}, I_{RRM}	-	-	10	μA
		-	-	2	mA
On-state voltage ⁽¹⁾ ($I_{TM} = 70\text{A}$) ($I_{TM} = 175\text{A}$) ($I_{TM} = 850\text{A}$, $t_w = 1\text{ms}$) ⁽²⁾ ($I_{TM} = 1700\text{A}$, $t_w = 1\text{ms}$) ⁽²⁾	MCR70 SERIES	-	1.5	1.85	Volts
	MCR71 SERIES	-	1.7	2.1	
	MCR70 SERIES	-	6	-	
	MCR71 SERIES	-	7	-	
Gate trigger current (continuous dc) ($V_D = 12\text{V}$, $R_L = 100\Omega$)	I_{GT}	2	10	30	mA

MCR70, MCR71 SERIES

SILICON CONTROLLED RECTIFIERS

Gate trigger voltage (continuous dc) ($V_D = 12V$, $R_L = 100\Omega$) ($V_D = \text{rated } V_{DRM}$, $R_L = 1k\Omega$, $T_j = 125^\circ C$)	V_{GT}	- 0.2	1 -	1.5 -	Volts
Holding current ($I_{TM} = 0.5A$, gate open)	I_H	3	15	50	mA
Latching current ($V_D = 12Vdc$, $I_G = 150mA$, $t_r \leq 50\mu s$)	I_L	-	30	60	mA
Critical rate of rise off state voltage ($V_D = \text{rated } V_{DRM}$, gate open, exponential waveform, $T_c = 125^\circ C$)	dv/dt	10	-	-	V/ μs
Turn on time ⁽³⁾ ($V_D = \text{rated } V_{DRM}$, $I_G = 150mA$) ($I_{TM} = 70A$, peak) ($I_{TM} = 110A$, peak)	MCR70 SERIES MCR71 SERIES	t_{on}	- -	1 1.2	μs

Notes:

1. Duty cycle $\leq 1\%$. Pulse width $\leq 300\mu s$.
2. Characteristic applies for $t_w = 1ms$. t_w is defined as 5 time constants of an exponentially decaying current pulse.
3. The gate controlled turn-on time in a crowbar circuit will be influenced by the circuit inductance.

MECHANICAL CHARACTERISTICS

Case:	TO-48
Marking:	Body painted, alpha-numeric
Polarity:	Anode is stud

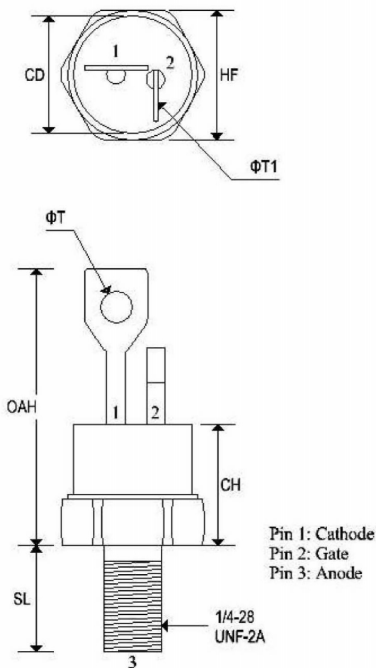

	TO-48			
	Inches		Millimeters	
	Min	Max	Min	Max
CD	-	0.543	-	13.793
CH	-	0.550	-	13.970
HF	0.544	0.563	13.817	14.301
OAH	-	1.193	-	30.303
SL	0.422	0.453	10.718	11.507
ΦT	0.125	0.165	3.175	4.191
ΦT_1	0.060	0.075	1.524	1.905

Note: Contour and angular orientation of terminals 1 and 2 with respect to hex portion and to each other are optional.

FIGURE 1 – PEAK CAPACITOR DISCHARGE CURRENT

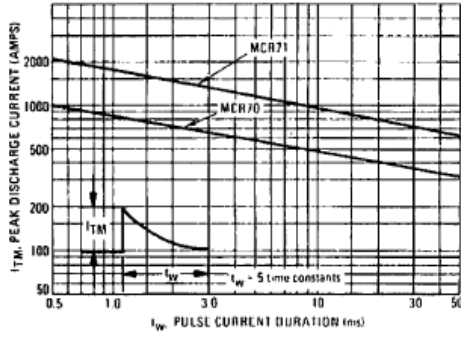

FIGURE 2 – PEAK CAPACITOR DISCHARGE CURRENT DERATING

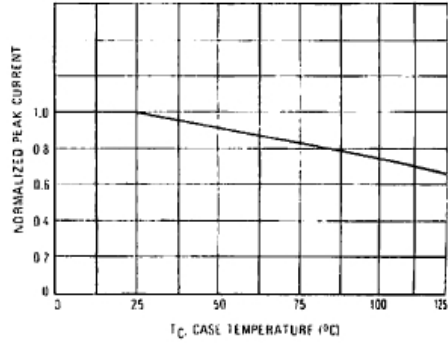

FIGURE 3 – AVERAGE CURRENT DERATING MCR70

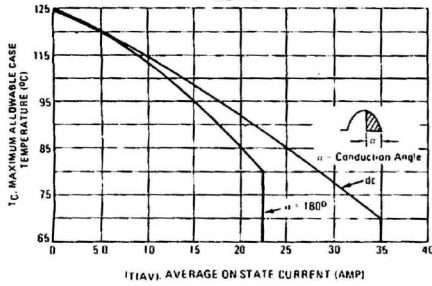

FIGURE 4 – POWER DISSIPATION MCR70

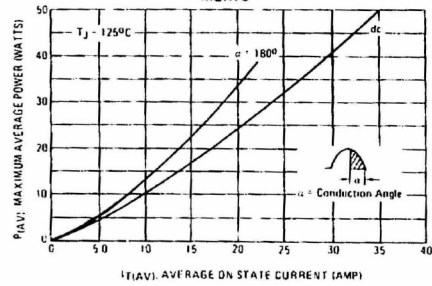

FIGURE 5 – CURRENT DERATING MCR71

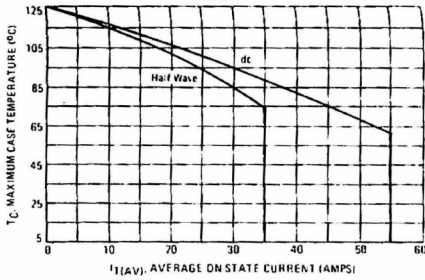

FIGURE 6 – POWER DISSIPATION MCR71

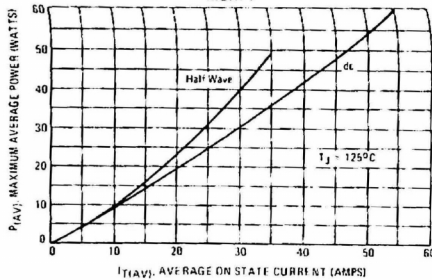

FIGURE 7 – TYPICAL THERMAL RESPONSE

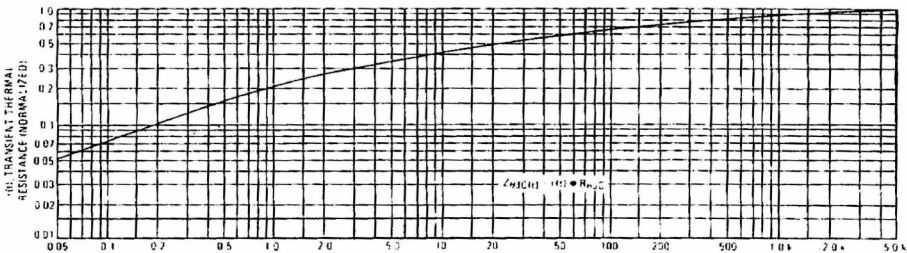

FIGURE 8 – GATE TRIGGER CURRENT

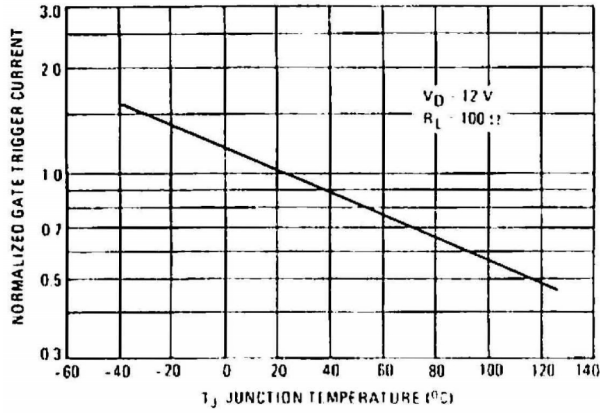

FIGURE 9 – GATE TRIGGER VOLTAGE

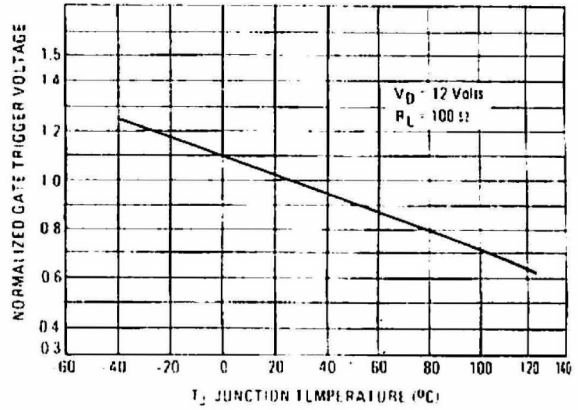

FIGURE 10 – HOLDING CURRENT

