

# DELL PowerVault MD3200/MD3220 Series of Storage Arrays

---

A Dell Technical Guide Book

Version 0.96

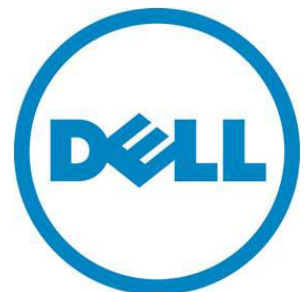

THIS WHITE PAPER IS FOR INFORMATIONAL PURPOSES ONLY, AND MAY CONTAIN TYPOGRAPHICAL ERRORS AND TECHNICAL INACCURACIES. THE CONTENT IS PROVIDED AS IS, WITHOUT EXPRESS OR IMPLIED WARRANTIES OF ANY KIND.

© 2010 Dell Inc. All rights reserved. Reproduction of this material in any manner whatsoever without the express written permission of Dell Inc. is strictly forbidden. For more information, contact Dell.

*Dell*, the *DELL* logo, and the *DELL* badge, *PowerConnect*, and *PowerVault* are trademarks of Dell Inc. *Microsoft*, *Windows*, *Windows Server* and *Hyper-V* are either trademarks or registered trademarks of Microsoft Corporation in the United States and/or other countries. Other trademarks and trade names may be used in this document to refer to either the entities claiming the marks and names or their products. Dell Inc. disclaims any proprietary interest in trademarks and trade names other than its own.

June 2010

## Contents

Product Overview .....	4
6Gb Serial Attached SCSI (SAS 2.0) .....	4
Chassis .....	8
Front View and Features .....	9
Hard Drives .....	14
Hard Drive Indicators .....	16
Storage Capacity Expansion .....	17
SAS Cables .....	18
6Gb SAS HBA.....	18
MD Storage Manager .....	19
MD3200 Series Storage Manager Software Packages .....	19
Enterprise Window .....	20
Array Window .....	21
Recovery Guru .....	28
Working with Physical and Logical Disks .....	29
Disk Group Configuration .....	29
Virtual Disk Configuration.....	30
Configuration Metadata .....	31
Global Hot Spares .....	31
Storage Partitioning.....	31
Snapshot .....	32
Virtual Disk Copy .....	32
Online Administration .....	33

Host Operating System Support .....	34
Environmental .....	35
Power Supply Specs .....	35
Thermal management .....	36
Over-Temperature Shutdown .....	36
Configuration Guidelines .....	38
General Configuration Rules.....	38

## Tables

Table 1. Selected Controller Features .....	8
Table 2. Detailed Dimensions (mm) .....	8
Table 3. MD3200 and MD3220 Front Panel Feature Description .....	11
Table 4. Power Indicator Description .....	14
Table 5. Supported Drives.....	15
Table 6. Drive Indicator Description .....	16
Table 7. RAID Configuration Support .....	30
Table 8. Supported Servers .....	35
Table 9. Power Supply Specifications .....	36
Table 10. Environmental Specifications.....	37

## Figures

Figure 1. Controller Architecture .....	5
Figure 2. MD3200 RAID Controller Module View - LEDs .....	6
Figure 3. MD3200 and MD3220 Dimensions .....	9
Figure 4. MD3200 Front View and Features .....	9
Figure 5. MD3200 Front Panel Indicators .....	10
Figure 6. MD3220 Front View and Features .....	10

Figure 7. MD3220 Front Panel Indicators .....	11
Figure 8. MD3200 and MD3220 Front Bezel Feature and Indicators.....	12
Figure 9. MD3200 and MD3220 Rear View .....	13
Figure 10. Power Supply Indicator Codes .....	13
Figure 11. Hard Drive Indicators (includes HDD and SSD).....	16
Figure 12. Expansion and cabling .....	17
Figure 13. Mini-SAS Cable Transition .....	18
Figure 14. MD Storage Manager: Enterprise Window .....	20
Figure 15. MD Storage Manager: Setup Tab .....	21
Figure 16. MD Storage Manager: Array Window.....	22
Figure 17. MD Storage Manager: Logical Tab.....	23
Figure 18. MD Storage Manager: Physical Tab .....	24
Figure 19. MD Storage Manager: Mappings Tab .....	25
Figure 20. MD Storage Manager: Setup Tab .....	26
Figure 21. MD Storage Manager: Access to Tasks.....	27
Figure 22. MD Storage Manager: Support Tab.....	28

## Product Overview

The PowerVault MD3200 is the next generation series of directly connected shared SAS arrays replacing the MD3000 product in the product portfolio. The MD3200 series of arrays provides vastly superior functionality over its predecessor and is industry leading in the areas of performance, flexibility and scalability.

The MD3200 series of arrays were designed with performance in mind. Each controller is equipped with four 6Gb SAS ports providing total aggregated bandwidth of 4,000MB/s of throughput for a dual controller system which is 4X the throughput of the MD3000 and the most competitive products in the external RAID SAS array market. For small block random access applications like databases, the MD3200 series is capable of performing over 2X the IOP performance of the MD3000 making it a great platform for a wide variety of applications and IT environments.

When it comes to flexibility, the MD3200 series of storage arrays is second to none. There are four base offerings to choose from allowing users to best meet their specific IT demands and budgets.

**MD3200 single controller model** - A single RAID controller in a 2U, 12 drive 3.5" HDD enclosure provides the lowest cost with the highest storage capacity offering when using large near-line SAS drives.

**MD3200 dual controller model** - Dual, active/active controllers in a 2U, 12 drive 3.5" HDD enclosure provides a high availability and high capacity storage offering when using large near-line SAS drives.

**MD3220 single controller model** - A single RAID controller in a 2U, 24 drive 2.5" HDD enclosure provides a low cost, high spindle count storage solution that maximizes IOPS when using SSD or 15K, 2.5" SAS drives.

**MD3220 dual controller model** - Dual, active/active controllers in a 2U, 24 drive 2.5" HDD enclosure provides the combination of a highly available storage solution with a high spindle count to maximize IOPS when using SSD or 15K, 2.5" SAS drives.

This series of arrays raises the bar for scalability in the entry-level storage space. Single controller models are capable of support up to four hosts connected to a single array. Dual controller models are capable of support up to four hosts with fully redundant I/O data paths or up to eight hosts with non-redundant data paths. Additional storage capacity can be added up to a maximum of 96 HDD via the MD1200 and/or MD1220 enclosures. Users can also mix 3.5" and 2.5" enclosures behind their base units in order to achieve the optimal drive tiering that best matches their application needs. Within each enclosure users can mix SSD, SAS and near-line SAS drives maximizing their return on investment.

In addition to the above mentioned features, the MD3200 series offers optional data protection features like snap shots and virtual disk copy services to assist users in protecting their data in a more effective manner. Initial set up is also much easier than the previous product with the addition of improvements in the Modular Disk Storage Manager.

## 6Gb Serial Attached SCSI (SAS 2.0)

SAS provides a scalable point-to-point topology capable of addressing storage connectivity at many levels. As SAS enters its second generation, the standard is evolving to enable better bandwidth utilization, easier management mechanisms, and network robustness.

6Gb/s SAS 2.0 not only doubles the current data transfer rate it provides standardized zoning, self-discovery, and self-configuration methods to expanders. This makes larger and more complex topologies easier than ever to implement.

Key features of SAS 2.0

- 6Gb/s SAS Signaling - doubles the transfer rate from 3Gb to 6Gb
- DFE (Decision Feedback Equalization) - increases cable limit to 10m ( 2 - 4 is typical)
- Supports SAS mini connectors (SFF-8088 and SFF-8087)
- SSC (Spread Spectrum Clocking ) - ease of design implementation - reduce peak amplitude of radiated emissions
- Supports SED (Self-Encrypting Drive) with Instant Secure Erase
- Delivers 2<sup>nd</sup> generation SAS Discovery
- Standardized Zoning
- Expanded to 256
- Discovery executed by SAS Expanders
- Reduces time to discover large topologies

Figure 1. Controller Architecture

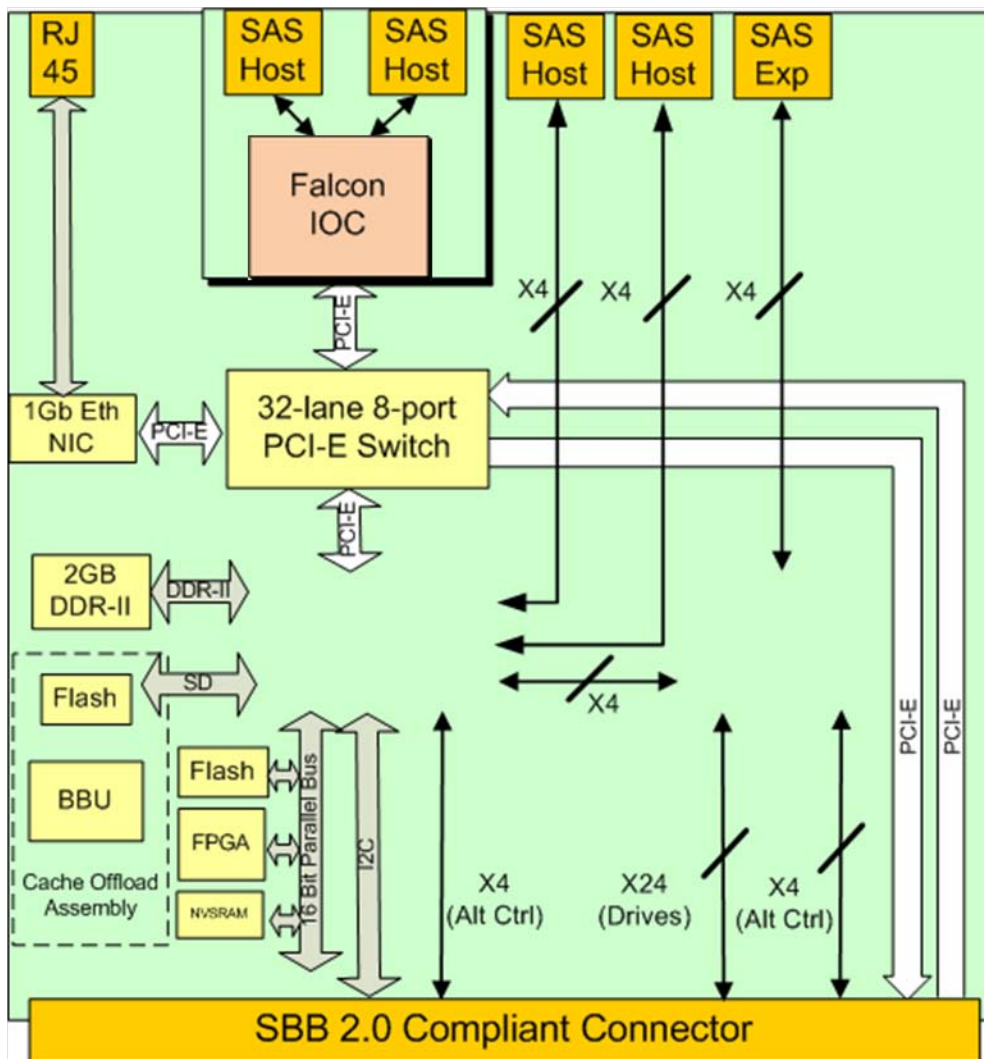

The RAID controllers are the “engines” or the “brains” of the MD3200 and MD3220 storage arrays. They perform the RAID calculations, control the I/O movement, communicate with the management client, store

the firmware, and protect data until it can be written safely to the hard disk drives. The MD3200's architecture is designed to excel in multi-host systems environments. Its I/O system core provides built-in hardware XOR for high-speed RAID parity calculations - enabling it to easily handle very compute-intensive tasks. Each RAID controller contains 2GB of cache for a total of 4GB of cache in a dual controller configuration which is mirrored with the other controller's cache for high availability. In the event of a power failure, the controllers are protected with battery assisted persistent cache backup which destages cache to non-volatile media for indefinite safe keeping.

Each controller has a 36-port 6 Gb/s SAS expander that provides access to the drives in the MD3200 or MD3220 enclosure. The SAS expanders enable each controller to access all of the drive ports, creating active/active drives loops that provide both controllers redundant access to all attached disk drives.

Each controller has the following external connections:



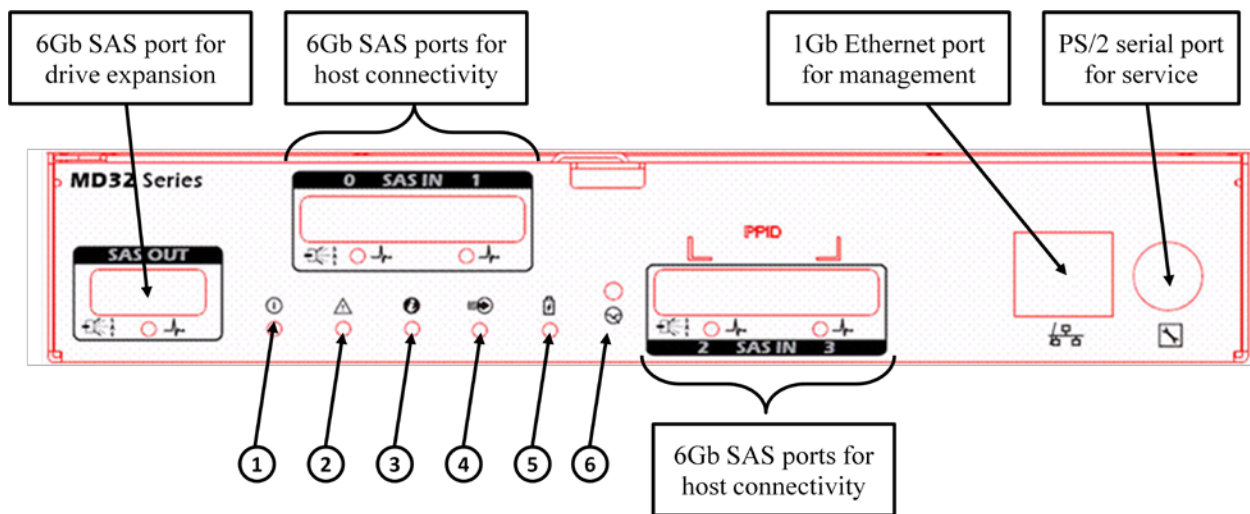

- Four 6Gb SAS ports for host connectivity
- One 6 Gb/s SAS port for drive enclosure expansion for additional capacity
- One Ethernet management ports for LAN out-of-band management
- One PS/2 serial interface for service

Figure 2. MD3200 RAID Controller Module View - LEDs



Location	LED Term	Color	Icon	General Behavior
1	Power	Green		OFF = No power applied ON = Power is applied



Location	LED Term	Color	Icon	General Behavior
2	Controller Fault	Amber		OFF = The controller is operating normally ON = The controller has defaulted
3	Controller Identifier	Blue		Indicates the location of the enclosure within the system.
4	Cache Active	Green		OFF = No data is in cache ON = Data is in cache
5	Battery Fault	Amber		OFF = The battery is operating normally ON = The battery has defaulted or is missing
6	Password Reset Switch	N/A		A button which allows the user to reset the default MD Storage Manager password

**Table 1. Selected Controller Features**

Automated I/O path protection with host-based, multipath failover drivers	One or more virtual disks per disk group
Automatic drive failure detection and rebuild using a global hot spare drive	Up to 256 virtual disks
Integrated storage partitioning, snapshot and virtual disk copy functionality	Dynamic disk group expansion
RAID levels 0, 1, 5, 6, 10	Dynamic virtual disk expansion
Greater than 2TB virtual disk size support	Dynamic RAID level migration
Smart battery allows the controller to monitor different parameters on the cache offload batteries such as state-of-charge and state of health	Dynamic capacity expansion
Dynamic segment size migration	Dynamic defragmentation
Up to 30 hard disk drives per disk group in a RAID5 and RAID6 and up to 96 drives in a RAID0 or RAID1	Non-disruptive firmware upgrades

## Chassis

### Dimensions and Weight

The PowerVault™ MD3200 and MD3220 enclosures use a rack mount 2U chassis.

**Table 2. Detailed Dimensions (mm)**

Model Number	Xa	Xb	Y	Za with bezel	Za with bezel	Zb	Zc	Max Sys Weight (kg)
PV MD3200	481.5	446.3	86.8	38.0	19.0	561.0	602.0	29.3
PV MD3220	481.5	446.3	86.8	38.0	19.0	508.0	549.0	24.2

Figure 3. MD3200 and MD3220 Dimensions

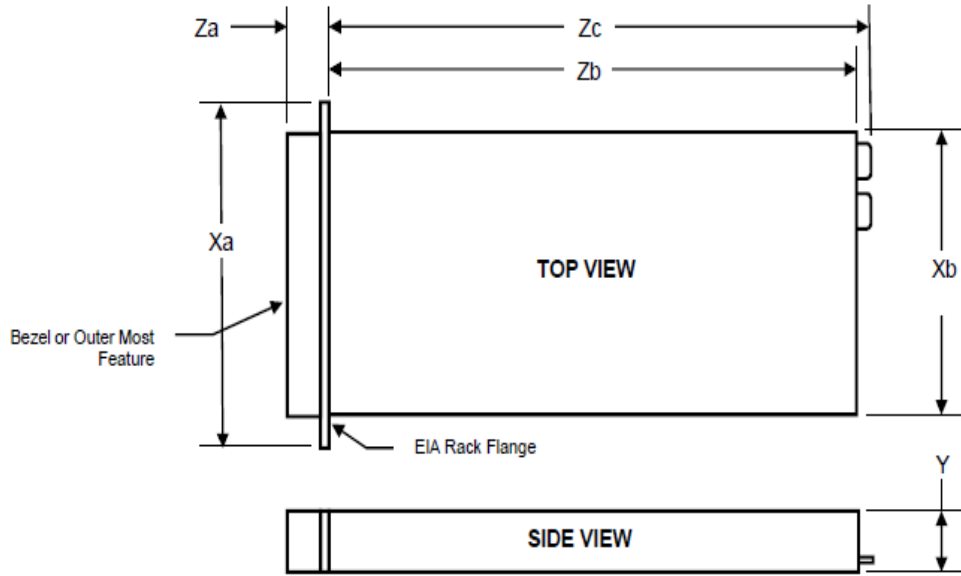

PowerVault™ MD3200: Weight (maximum configuration) 29.3 kg (64.6 lb)

PowerVault™ MD3220: Weight (maximum configuration) 24.2 kg (53.4 lb)

### Front View and Features

Figure 4. MD3200 Front View and Features



Figure 5. MD3200 Front Panel Indicators

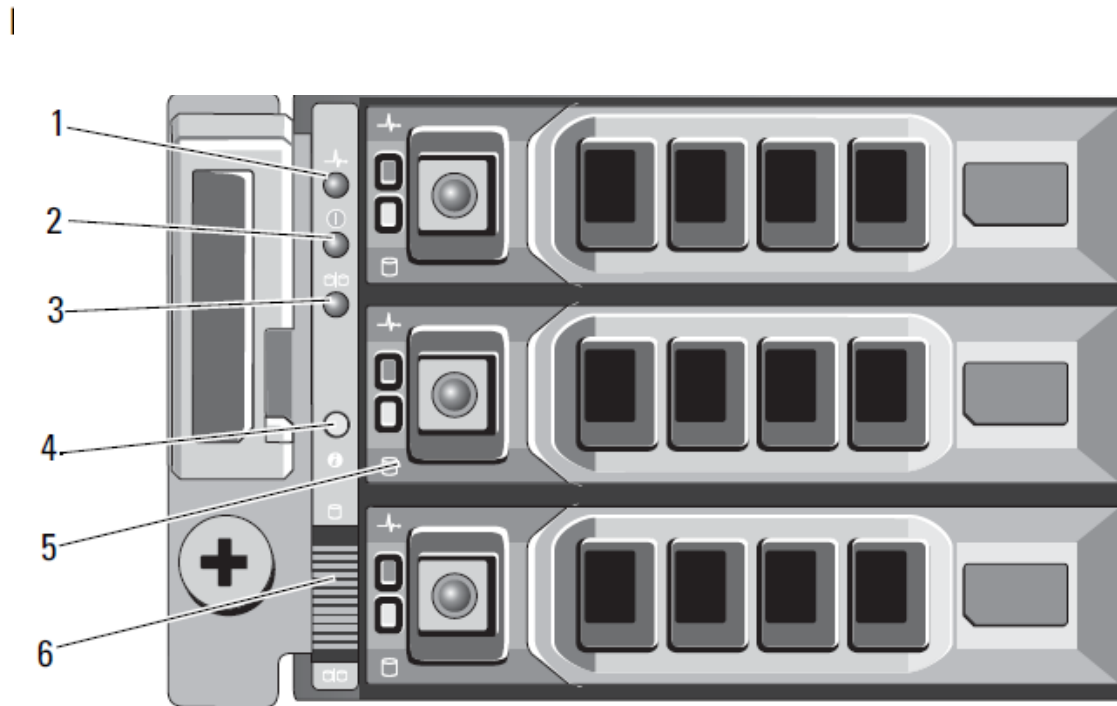

Figure 6. MD3220 Front View and Features



Figure 7. MD3220 Front Panel Indicators



Table 3. MD3200 and MD3220 Front Panel Feature Description

FRONT PANEL / BEZEL INDICATOR AND FETAURE DESCRIPTION			
Item	Indicator, Button, or Connector	Icon	Description
1	Enclosure status LED		<p>The enclosure status LED lights when the enclosure power is on.</p> <p>Lights blue during normal operation and when the management software is identifying the enclosure.</p> <p>Blinks blue when the management software is identifying the enclosure or when the system identification button is pressed.</p> <p>Lights amber when the enclosure is turned on or is reset.</p> <p>Blinks amber when the enclosure is in the fault state.</p>
2	Power LED		<p>The power LED lights when at least one power supply is supplying power to the enclosure.</p>



FRONT PANEL / BEZEL INDICATOR AND FETAURE DESCRIPTION			
Item	Indicator, Button, or Connector	Icon	Description
3	Not Applicable		This LED has no use in the MD3200 or MD3220.
4	System Identification Button		The system identification button on the front control panel can be used to locate a particular enclosure within a rack. When the button is pushed, the system status indicators on the control panel and the RAID controllers blinks blue until the button is pushed again.
5	Hard Drives		MD3200—Up to 12 SAS hot-swappable drives. MD3220—Up to 24 2.5-inch SAS hot-swappable drives.
6	Not Applicable		This switch has no use on the MD3200 or MD3220.

Figure 8. MD3200 and MD3220 Front Bezel Feature and Indicators

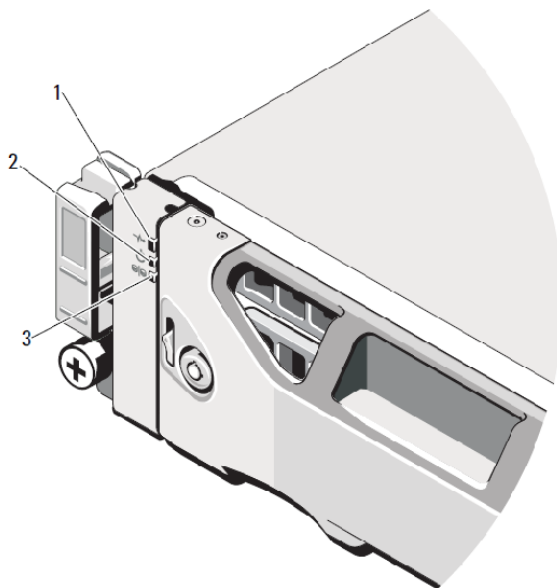

Figure 9. MD3200 and MD3220 Rear View

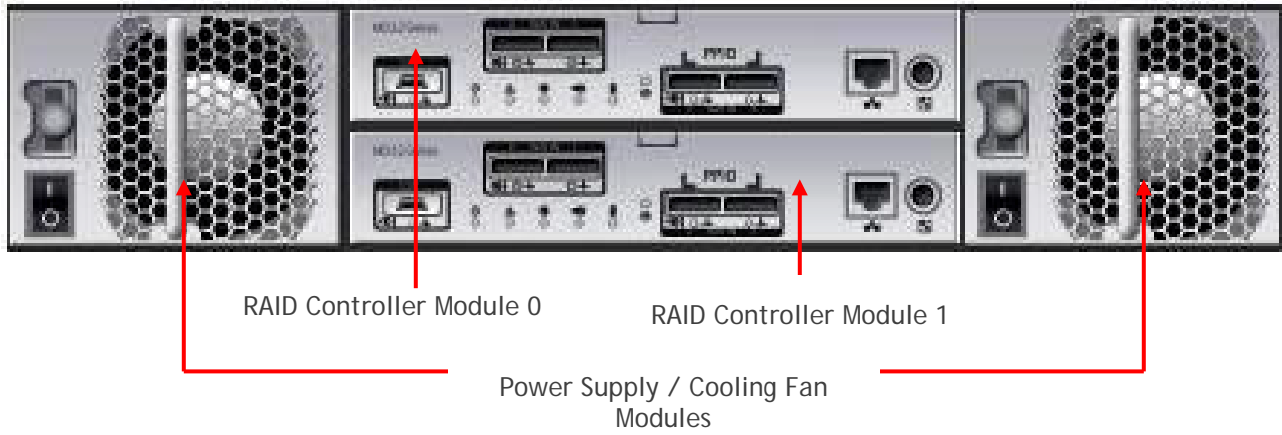
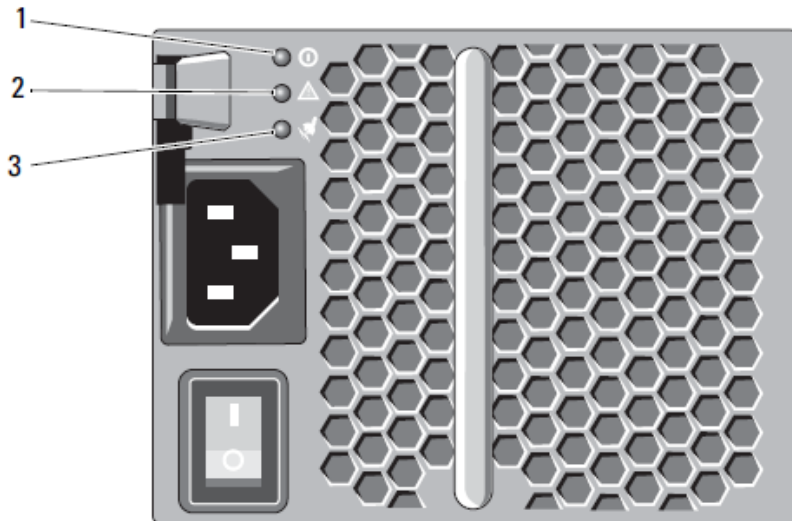





Figure 10. Power Supply Indicator Codes



**Table 4. Power Indicator Description**

POWER INDICATOR AND FETAURE DESCRIPTION			
Item	Indicator, Button, or Connector	Icon	Description
1	DC Power		<p>The LED lights green when the DC output voltage is within the limit.</p> <p>If this LED is off, it indicates that the DC output voltages are not within the limit.</p>
2	Power supply/cooling fan fault		<p>The LED lights amber when the DC output voltage is not within the limit or a fault with the fan is detected. If this LED is off, it indicates that no fault condition is present.</p>
3	AC Power		<p>The LED lights green when the AC input voltage is within the limit.</p> <p>If this LED is off, it indicates either there is no power or the AC input voltage is not within the limit.</p>

## Hard Drives

The MD3200 and MD3220 support SAS hot-pluggable HDDs (hard-disk drives) and SSD (solid-state drives). MD3200 allows for both 3.5-inch and 2.5-inch form factor drives, and the MD3220 allows for 2.5-inch form factor drives. Note that 2.5" HDD in the MD3200 requires a unique drive carrier that houses a 2.5" HDD and fits into a 3.5" HDD slot. Any combination of SAS rotational speeds and SSD drives can be mixed within an MD3200 or MD3220 enclosure.



**Table 5. Supported Drives**

Form Factor	Speed (rpm)	Capacity (GB)
2.5" SAS  HDDs up to 6Gb/s  SSDs up to 3Gb/s	7,200	500 GB
	10,000	146 GB
		300 GB 600GB (post RTS)
	15,000	73 GB
146 GB		
SSD	150 GB	
3.5" SAS  HDDs up to 6Gb/s	7,200	500 GB
		1 TB 2 TB
15,000	300 GB	
	450 GB	
	600 GB	

SATA interface drives are not supported with the MD3200 and MD3220.  
 6Gb/s SAS interface HDDs and 3Gb/s SAS interface SSDs are configured in the MD3200 and MD3220, from Dell's factory.

3Gb/s SAS interface HDDs are supported in the field with the supported MD3200 carrier.  
 The front bezel of the system contains a lock. A locked bezel secures the system hard drives.

## Hard Drive Indicators

Figure 11. Hard Drive Indicators (includes HDD and SSD)



1 hard-drive activity indicator (green) 2 hard-drive status indicator (green and amber)

Table 6. Drive Indicator Description

Drive-Status Indicator Pattern (RAID Only)	Condition
Blinks green two times per second	Identify drive/preparing for removal
Off	Drive ready for insertion or removal  NOTE: The drive status indicator remains off until all hard drives are initialized after system power is turned on. Drives are not ready for insertion or removal during this time.
Blinks green, amber, and off	Drive predicted failure
Blinks amber four times per second	Drive failed
Blinks green slowly	Drive rebuilding
Steady green	Drive online
Blinks green three seconds, amber three seconds, and off six seconds.	Rebuild aborted

## Storage Capacity Expansion

Both the MD3200 and MD3220 systems are capable of supporting up to 96 total hard drives. Adding additional drives past what the base platforms hold is a simple matter of connecting either MD1200 and/or MD1220 JBODs to the expansion ports on the MD32X0. Users can mix and match the MD1200 (3.5" HDD enclosure) and the MD1220 (2.5" HDD enclosure) in any combination that provides them the best mix of drives for their environment up to a total of 96 drive slots. The diagram below shows the proper way to cable JBODs to the MD32X0 storage arrays.

If using 100% MD1200 enclosures for storage expansion on an MD3200 a total of seven MD1200 enclosures can be added to achieve a total of 96 HDD. If using 100% MD1220 enclosures for expansion on an MD3200, a total of three MD1220 enclosures can be added. Adding three MD1220 enclosures provides a total of 84 HDD slots.

If using 100% MD1220 enclosures for storage expansion on an MD3220, a total of three MD1220 enclosures can be added to achieve a total of 96 HDD. If using 100% MD1200 enclosures for expansion on an MD3220, a total of six MD1200 enclosures can be added to achieve a total of 96 HDD.

It is important to note that the older 3Gb SAS JBODS (MD1000 and MD1120) cannot be used as expansion enclosures on the MD3200 or the MD3220.

Figure 12. Expansion and cabling

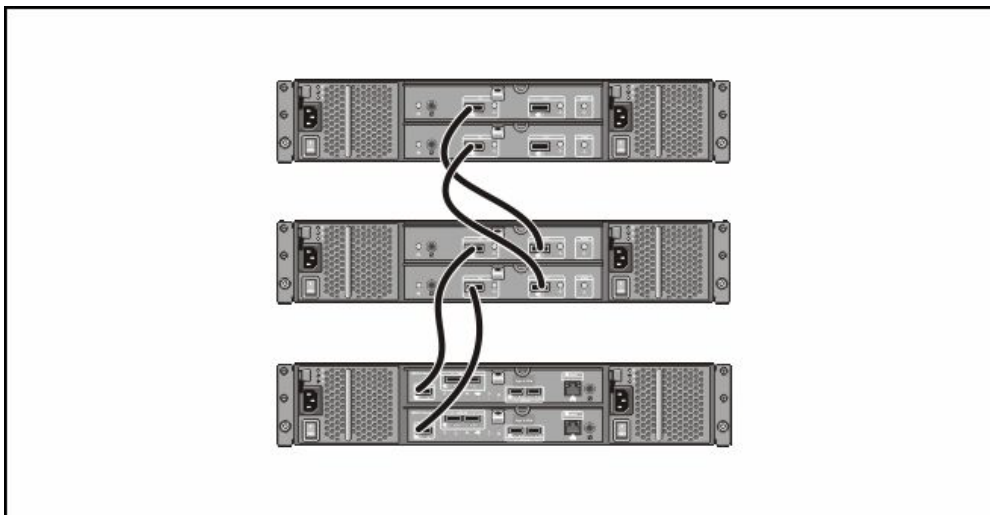

## SAS Cables

The MD3200 and MD3220 arrays and the MD1200 and MD1220 JBODs standardize on the 6Gb/s (SAS 2.0) Mini-SAS cable (SFF 8088). The Mini-SAS cable is unique from the SAS cable used with the previous MD3000 array and MD1000 JBOD.

Figure 13. Mini-SAS Cable Transition

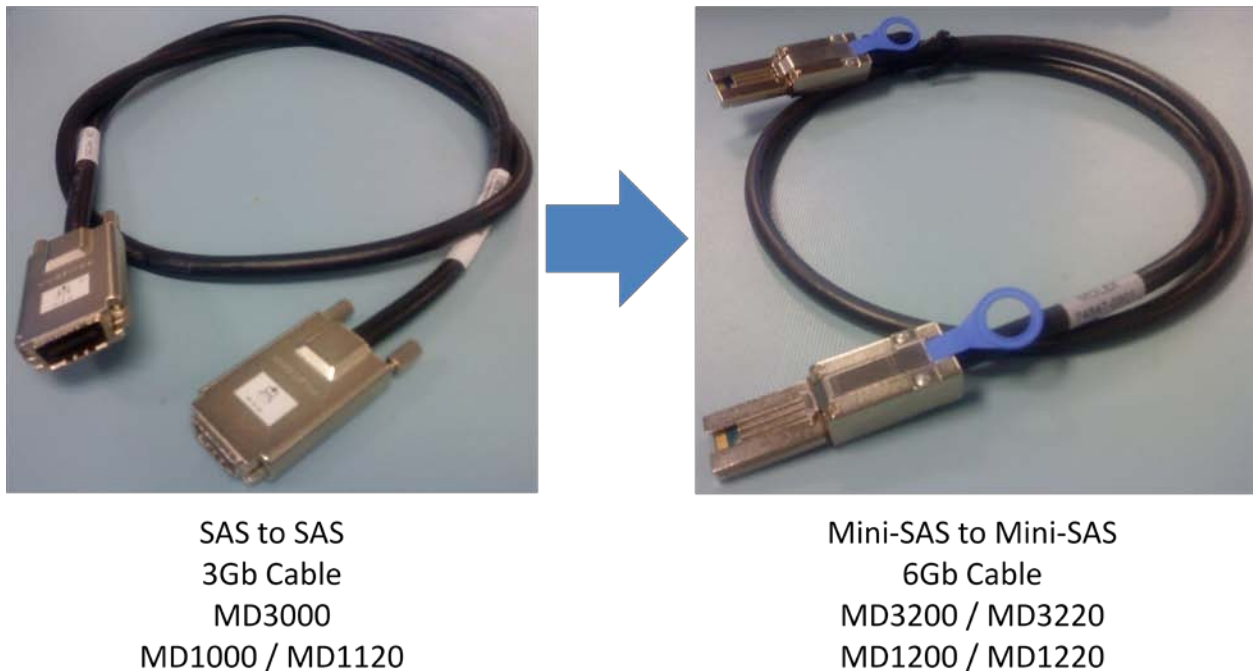

Connectors on both ends of the Mini-SAS cable are universally keyed. Either end of the cable can be connected to the host, MD3200 RAID controllers or JBODs.

To remove the Mini-SAS cable, pull the pull-tab to release the cable from the connector on the EMM and the host system.

## 6Gb SAS HBA

Connecting the MD3200 and MD3220 to servers requires the use of the 6Gb SAS HBA. The SAS 5/E HBA will not work with the MD3200 series of arrays. Key features of the 6Gb SAS HBA:

- Dual ports
- PCI Express 2.0 Host Interface
- SAS 2.0 compliant
- Fits in standard PCI Express card slots
- Standard ½ length & ½ height card design
- Coexistence with PERC H700, H800 and PERC 6 in the same server
- Coexistence with PERC H200, SAS 6 and SAS 5 in the same server
- Support for select 9G (Tape Only), 10G, 11G Platforms

## MD Storage Manager

The MD Storage Manager provides the perfect combination of robustness and ease-of-use—two attributes not commonly found together in an entry-level storage management tool. The new MD Storage Manager graphical user interface (GUI) is ideally suited for the full-time storage administrator, who wants complete control over their storage configuration, as well as the part-time system administrator, who needs an intuitive interface that helps them ensure optimal storage utilization.

- Features of the next generation MD Storage Manager:
- Automated I/O path protection with host-based, multipath, failover drivers
- Centralized management of one or more MD3200 and/or MD3220 arrays from any location
- Backwards compatibility with MD3000 and/or MD3000i arrays
- Integrated storage partitioning, snapshot and virtual disk copy functionality
- Support for up to 8 partitions
- Support for up to 8 snapshots per virtual disk and a total of 128 snapshots per system
- Support for up to 8 simultaneous virtual disk copies per array and a total of 255 copies per system.
- RAID levels 0, 1, 5, 10 and 6 supported
- Up to 30 physical disks supported per disk group (RAID levels 5 and 6)
- Up to 96 drives in RAID level 0
- Up to 96 drives in RAID level 1/10
- Local key management for SDE enabled drives
- One or more virtual disks per disk group
- Up to 256 virtual disks (LUNs) per array
- Dynamic capabilities support on-the-fly reconfigurations
- Dynamic disk group expansion
- Dynamic RAID level migration
- Dynamic virtual disks expansion
- Dynamic capacity expansion
- Dynamic segment size migration
- Dynamic defragmentation
- Non-disruptive firmware upgrades
- Support for unlimited hot spares

## MD3200 Series Storage Manager Software Packages

The MD3200 series Storage Manager software contains the following four packages:

**Client** - This package contains the graphical user interfaces (GUI) for monitoring and managing the storage arrays. It also contains an optional monitor service used to send alerts when there is a critical problem with the storage arrays.

**Utilities** - This package contains several providers to simplify integration with Microsoft tools (VSS and VDS) and integration to 3<sup>rd</sup> party management tools that take advantage of SMI-S protocols.

**Agent** - This package contains software that allows a storage management station to communicate with the controllers in the storage array over the I/O path of a host.

**Failover Driver** - This package contains the multi-path driver used to manage the I/O paths into the controllers in the storage array. If there is a problem on the path or a failure of one of the controllers, the driver automatically re-routes the request from the hosts to the other controller in the storage array.

## Enterprise Window

The Enterprise Window is the main window that opens when the MD Storage Manager is initially launched. Within the **Device** tab, it provides a view of all of the storage arrays, including partially managed storage arrays, in the overall management domain. It also allows for the automatic or manual addition and removal of storage and provides a view of all the MD arrays including prior generation MD3000 and MD3000i arrays

Figure 14. MD Storage Manager: Enterprise Window

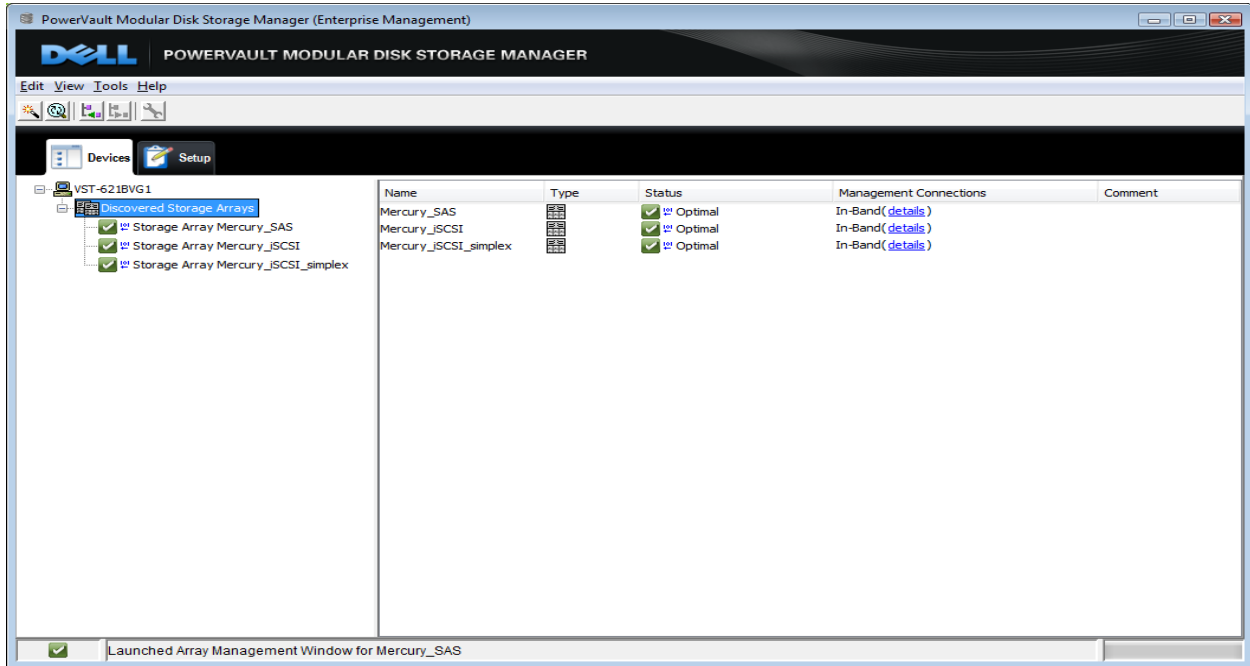

The Enterprise Window **Setup** tab is also accessible in the Enterprise Window. This **Setup** tab provides quick access to common setup tasks. For example, from the **Setup** tab window, a user can upgrade controller firmware, set alert notifications (email and SNMP), and perform other high-level configuration functions.

Figure 15. MD Storage Manager: Setup Tab

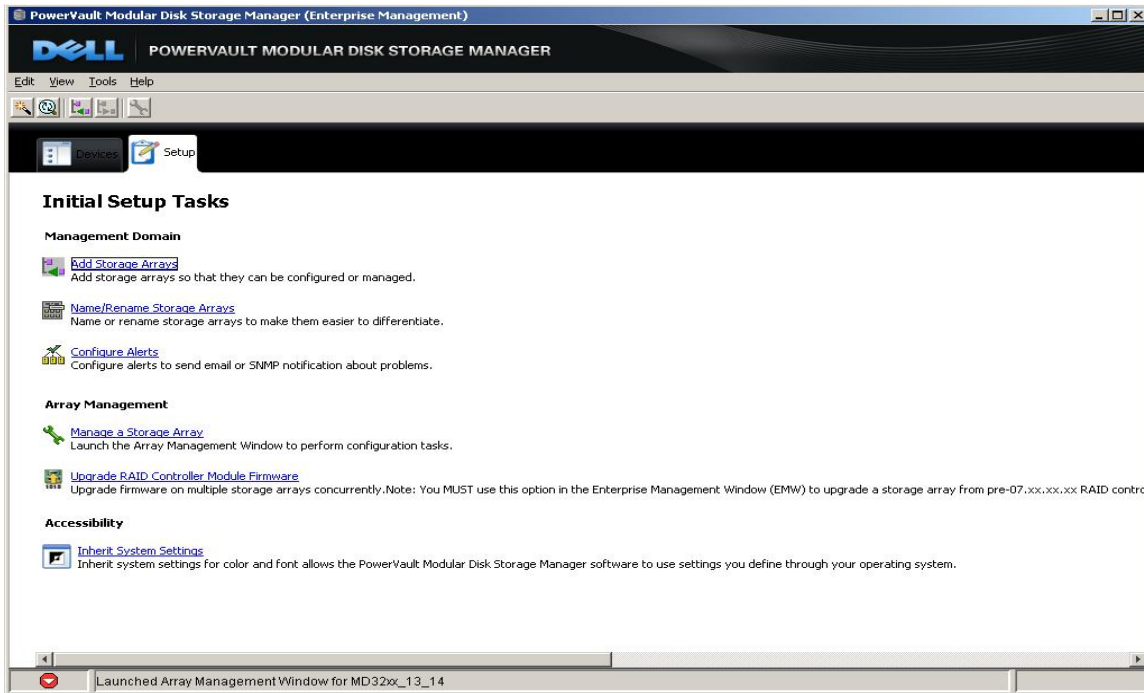

There are two ways to select an array to manage from the Enterprise Window. This includes;

Clicking the **Manage a Storage Array** in the **Setup** tab, then select the desired storage array; or,

go to the **Devices** tab and double-click on a storage array

Either of these two options will open the Array Window for the selected storage array.

## Array Window

The Array Window provides all of the functions to configure, maintain and troubleshoot any individual storage array. Multiple Array Windows can be open at the same time to manage multiple storage arrays if the need to do so every arises. The Array Window provides a task-oriented user interface and is designed to be both informative and intuitive. From any of the six primary tabs located on the Array Window - **Summary**, **Logical**, **Physical**, **Mapping**, **Setup** and **Support** - users can simply make changes on the fly to quickly adapt their array to meet their needs.

Figure 16. MD Storage Manager: Array Window

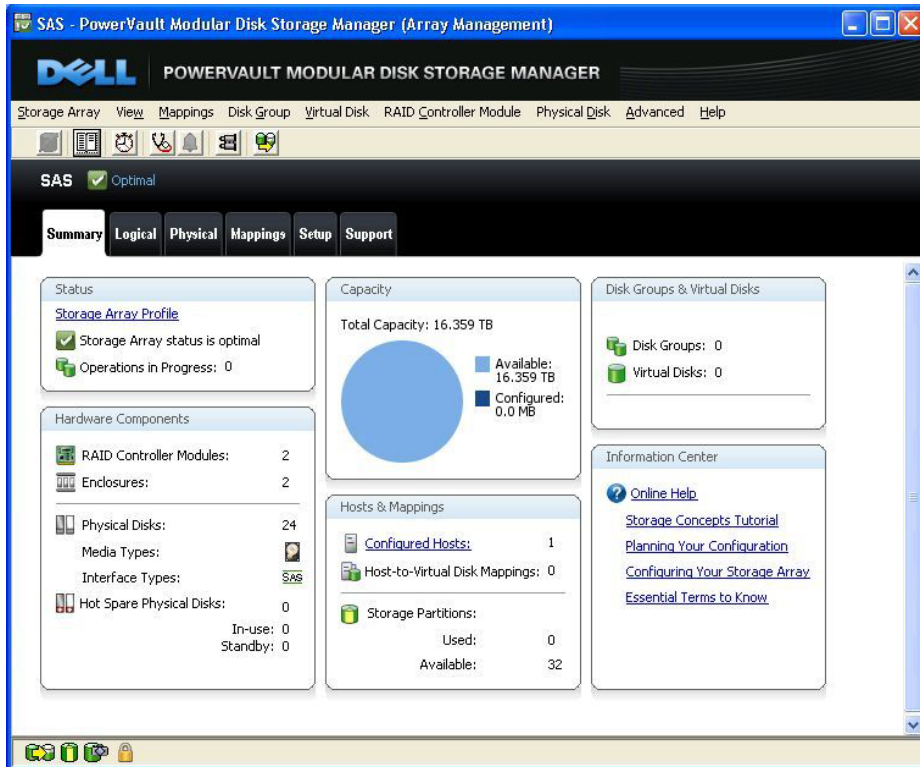

The **Summary** tab (shown above) provides administrators with a quick look at all the pertinent information regarding the selected MD3200 or MD3220 storage array as well as links to various management tasks. These include:

A **Status** area which indicates whether the storage array is in an optimal state, whether there are any long-running operations in progress with the ability to view the operations and whether alert notifications have been set. If the array is in a non-optimal state, a link is provided to launch the Recovery Guru. The Recovery Guru provides valuable troubleshooting assistance by diagnosing storage array problems and determining the appropriate procedure to use for recovery. The Recovery Guru displays a summary list of storage array problems, detailed information about a selected problem, and recovery steps to follow for the selected problem.

The **Capacity** section provides an indication of the total capacity available on the storage array and the configured and available capacity.

The **Disk Groups & Virtual Disks** area provides basic information on the number of disk groups, virtual disks, and RAID levels used on the storage array. In addition, a link is provided to allow the user to view additional disk group and virtual disk information in a non-embedded dialog.

The **Hardware Components** area provides basic hardware information about the selected storage array such as the number of physical disks, media types and if there are any configured hot spare physical disks.



The *Hosts & Mappings* area provides information about the number of hosts, virtual disk mappings, and storage partitions that have been configured. There is also a link provided to allow the user to get more detailed information about the hosts and mappings by launching a non-embedded dialog.

The *Information Center* area provides links to various help-related information and tutorials.

The *Logical* tab is the second tab accessible on the Array Window and contains two panes: the *Logical* pane and the *Properties* pane.

Figure 17. MD Storage Manager: Logical Tab

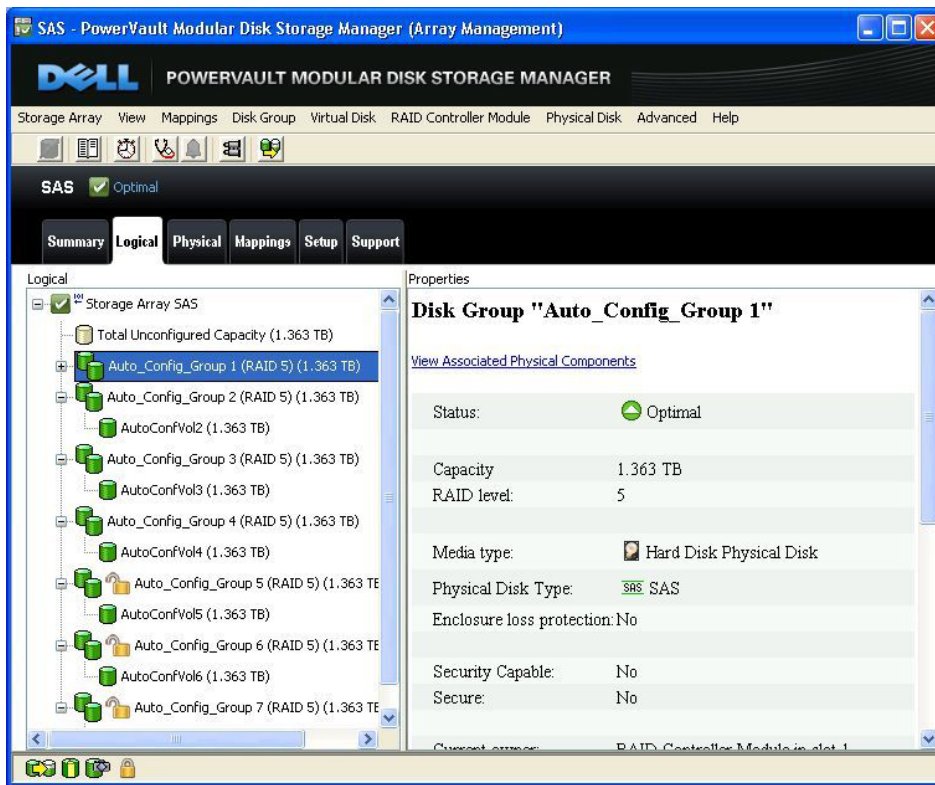

The *Logical* pane provides a tree-structured view of the array's disk configurations. Clicking the plus (+) sign or the minus (-) sign adjacent to the array will expand or collapse the view. These views under the storage array include un-configured capacity as well as configured disk groups and their associated virtual disks. Snapshots, if any, can also be viewed from the virtual disk in which they reside.

The *Properties* pane provides detailed information about the component selected in the *Logical* pane. The information varies depending on what type of component is selected. Information may include whether the component is in an optimal status, total capacity, RAID level, media and interface type as well as controller ownership.

The physical component's overview is provided in the *Properties* pane and is associated with the logical component selected in the *Logical* pane. A greater detailed view can be found by right-clicking a

component, and selecting “View Associated Physical Components”. This physical view can also be retrieved by selecting the **Physical** tab which will be covered next.

The **Physical** tab provides both a physical view of the storage array as well as detailed information regarding the physical components. Within the **Physical** tab, the *Physical* pane appears on the left and the *Properties* pane appears on the right. The *Physical* pane shows a graphical representation of the physical components in the storage subsystem, such as the RAID controller modules and the expansion enclosures while the *Properties* pane displays detailed information about the component that is selected in the *Physical* pane.

Figure 18. MD Storage Manager: Physical Tab

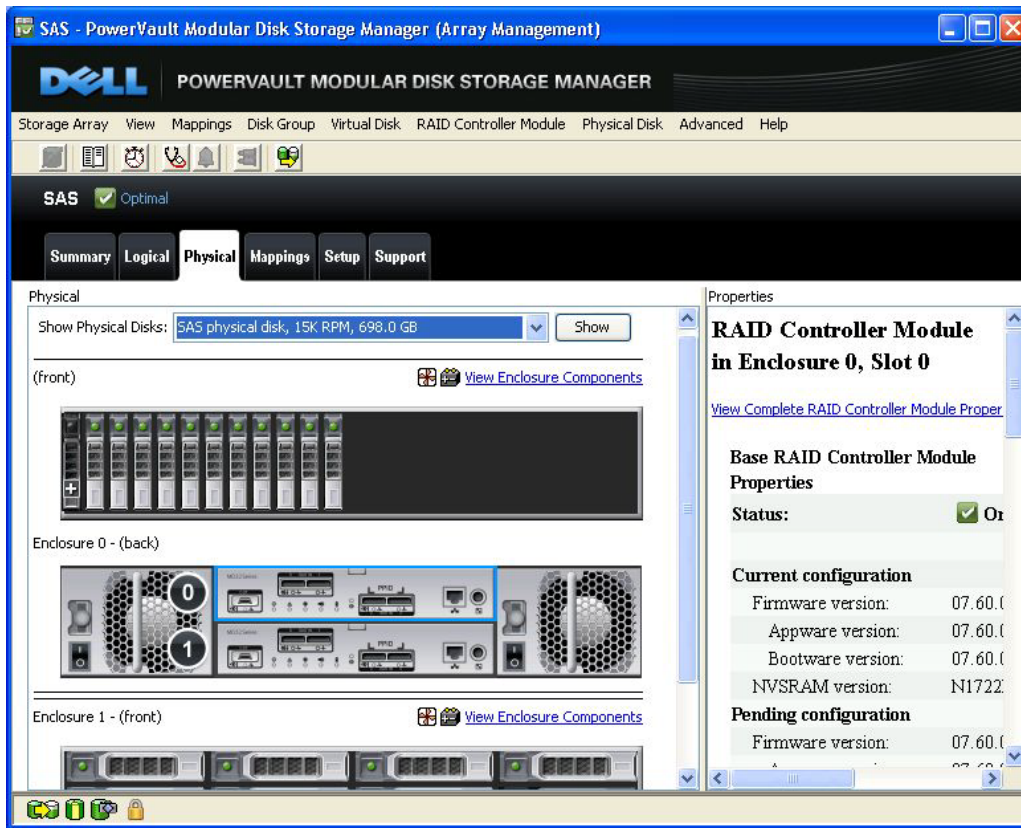

The drop down menu in the *Physical* pane allows the user select which physical components they would like displayed in the *Properties* pane.

Next, is the **Mappings** tab which provides an overall view of the host-to-virtual disk mappings configured on the storage array. The **Mappings** window includes both a *Topology* pane as well as a *Defined Mappings* pane.

Figure 19. MD Storage Manager: Mappings Tab

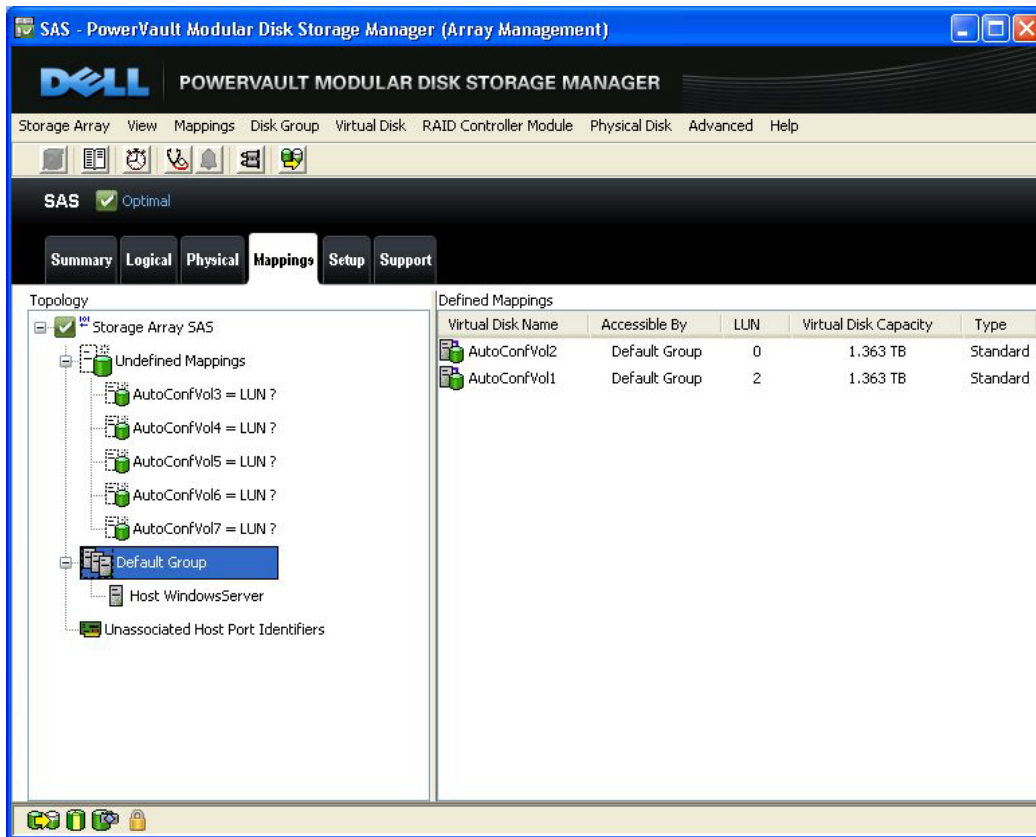

The *Topology* pane shows a tree-structured view of virtual disk that are related to the storage partitions. Click the plus (+) sign or the minus (-) sign adjacent to a node to expand or collapse the view. Users can right-click a node to open a pop-up menu that contains the applicable actions for that node. Views include undefined mappings within the storage array as well as the servers connected to the storage array.

Once a virtual disk is selected, the *Defined Mappings* pane will provide mapping information pertinent to that node. By clicking on the storage array for example, the virtual drives associated with the storage array will be listed as well which hosts they are accessible. By selecting a host, the user can also see a list of virtual disks assigned to it.

The user can also create mappings by right-clicking on a virtual disk in the *Topology* pane and selecting "Partitioning", which allows them to create mappings via a Wizard and will quickly create a new single partition. A user can also select "Define Additional Mappings" to define additional mappings. This step allows the user to map the virtual disk to additional host of host groups in an existing storage partition.

The next tab is the **Setup** tab which provides access to nearly all routine administrative tasks that a user would typically run into.

Figure 20. MD Storage Manager: Setup Tab

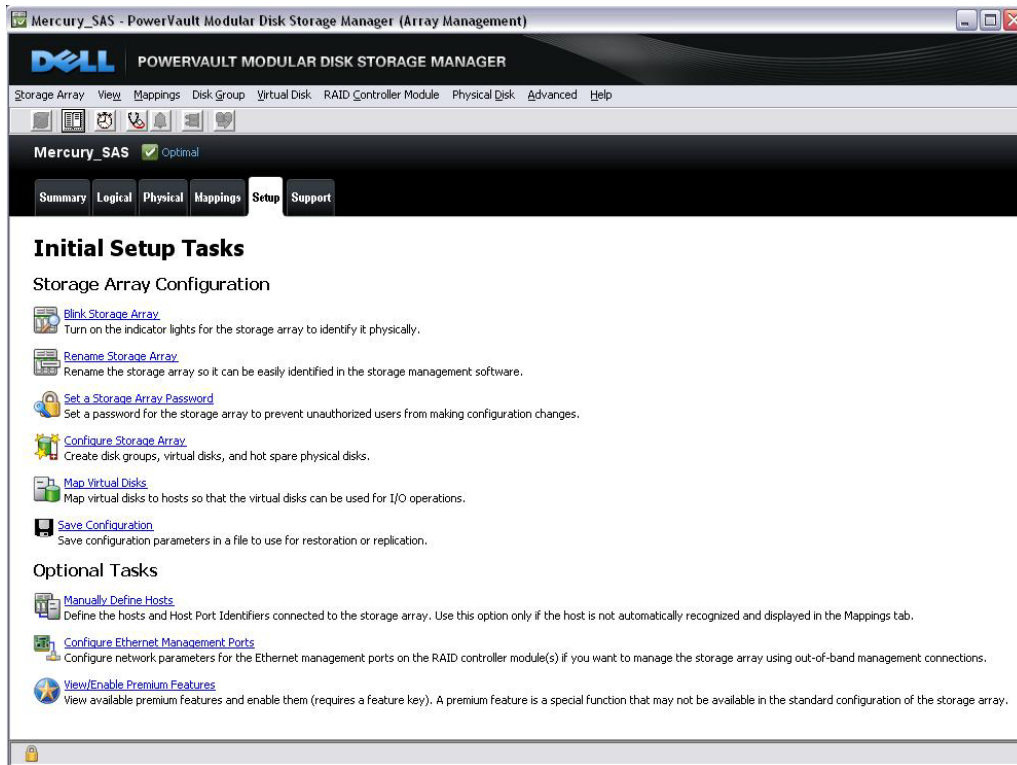

The **Setup** tab includes tasks, such as:

**Blink Storage Array** selection which allows the user to turn on the indicator lights of the storage array to identify it physically.

**Rename Storage Array** allows for the storage array to be renamed so it can be easily identified in the storage management software.

**Set a Storage Array Password** prompts the user for a new password for the storage array to prevent unauthorized users from making configuration changes.

**Configure Storage Array** is a key task which allows the user to create disk groups, virtual disks and hot spare physical disks.

**Map Virtual Disks** option provides for the user to map virtual disks to hosts to that the virtual disk can be used for I/O operations. As mentioned previously, this can also be accomplished from the **Mappings** tab.

**Save Configuration** selection, users can save their configuration parameters in a file to use for restoration or replication.

It is important to note that many tasks can also be accessed from the pull down menus across the top;

Storage Subsystem View Mappings Array Logical Drive Controller Drive Advanced Help

or, by going to the Logical, Physical or Mappings tabs in the Array Window and right-clicking on the appropriate object (i.e. storage array, virtual disk drive, controller, etc.). For example, right-clicking on an array provides the same options as clicking on the Setup tab or the top pull down menus options.

Figure 21. MD Storage Manager: Access to Tasks

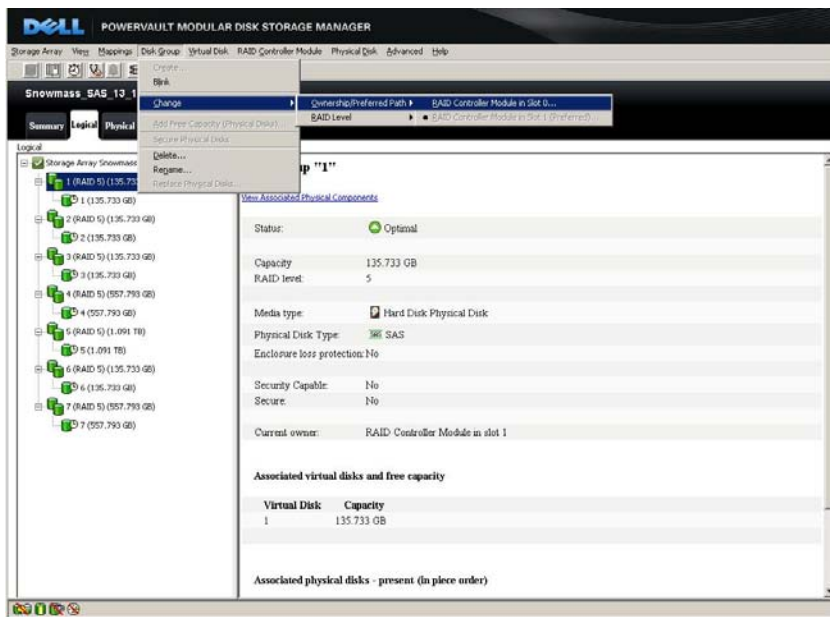
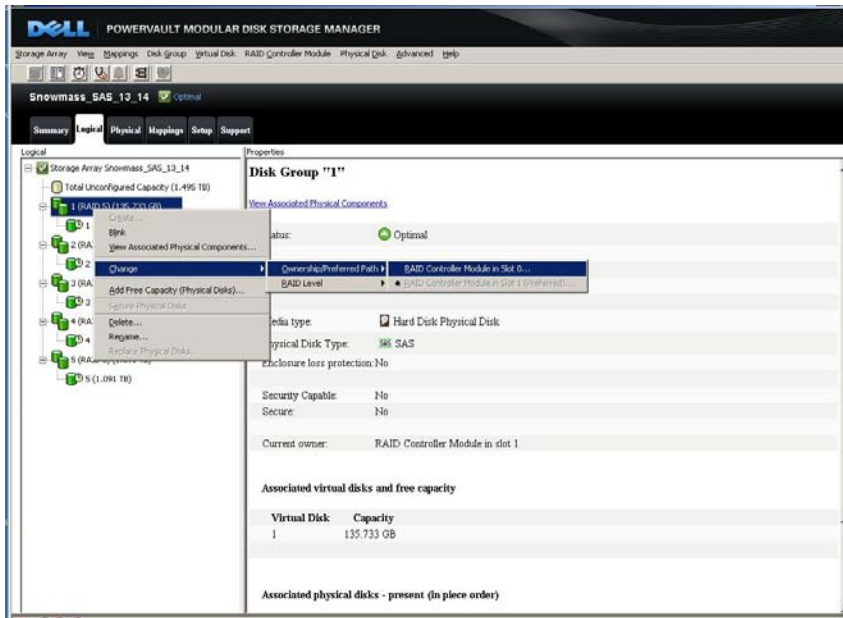



The final tab is the **Support** tab which provides a central location when storage array recovery, support information or a description of the storage array components are needed.

Figure 22. MD Storage Manager: Support Tab

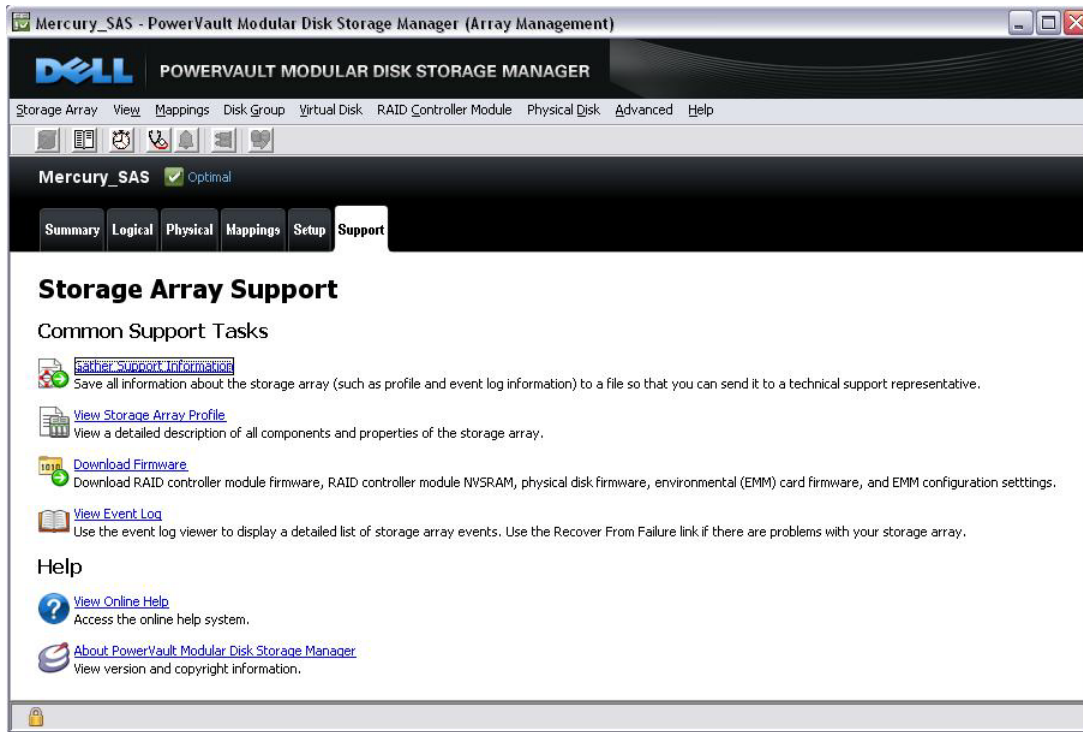

*Gather Support Information* selection allows a user to save information about the storage array (such as its profile and event log information) to a file so that it can be saved and sent it to technical support.

*Storage Array Profile* provides a detailed description of all components and properties of the storage array such as the number of physical drives used, firmware versions of the controller(s), which components are running optimally and the number of Snapshots taken.

*Download Firmware* option allows the user to download RAID controller module firmware, NVSRAM, physical disk firmware, environmental management module (EMM) firmware and EMM configuration settings.

*View Event Log* will provide a detailed list of storage array events.

*View Online Help* is available for detailed instructions on how to accomplish any of the tasks in the Array Window to optimally configure the storage array.

## Recovery Guru

If a problem should ever arise with the array, the Recovery Guru provides valuable troubleshooting assistance by diagnosing storage array problems and determining the appropriate procedure to use for recovery. The Recovery Guru displays a summary list of storage array problems, detailed information about a selected problem, and recovery steps to follow for the selected problem.

## Working with Physical and Logical Disks

### Disk Group Configuration

A disk group is a set of physical disks that the controller logically groups together to provide one or more virtual disks to a host. Each disk group is comprised of the same drive technology (i.e. SAS, near-line SAS or SSD) and has an assigned RAID level. While multiple RAID levels can be intermixed in a single MD3200 series storage array, each disk group has a single RAID level. The number of physical disks that make up a disk group can be selected manually or automatically. When using the MD Storage Manager software's automatic configuration option, disk groups will be configured balancing the load across as many physical disk channels and physical disk modules as possible. This ensures maximum protection and performance.

MD Storage Manager software also provides the ability to dynamically add additional physical disks to existing disk groups. Existing virtual disks are then re-stripped across all physical disks in the newly expanded disk group. This takes place while the disk group and all its virtual disks remain online and accessible for I/O.

The selection of the RAID configurations is equally critical for each application to meet the desired data availability, performance or capacity requirements. And like physical disk types and configuration settings, the MD3200 series of arrays support the intermixing of RAID configurations to provide maximum flexibility and utilization. RAID 5 is generally considered the best balance of cost, performance and reliability. The table below outlines the tradeoffs of the various supported RAID configurations.

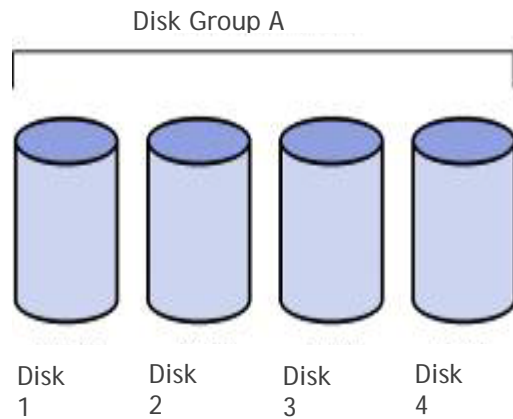
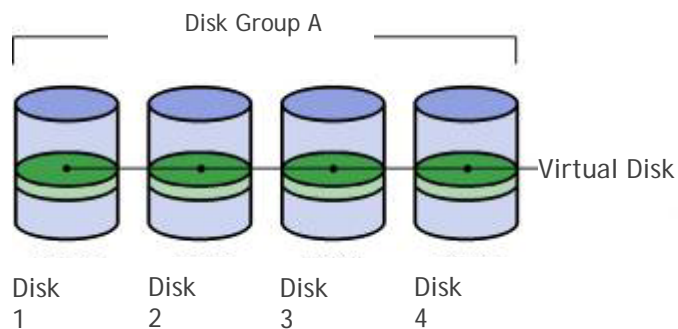

**Table 7. RAID Configuration Support**

	RAID-0	RAID-1 and 1+0	RAID-5	RAID-6
Description	Data is striped across multiple physical disks.	Data is "mirrored" to another physical disk.	Physical disks operated independently with data and parity blocks distributed across all physical disks in the group.	Physical disks operated independently with data and dual parity blocks are distributed across all physical disks in the group.
Min # of physical disks in a disk group	1	2	3	4
Max # of physical disks in a disk group	96	96	30	30
Usable capacity as % of raw capacity	100%	50%	66.67% to 96.67%	50% to 93.33%
Application	IOPS   MB/s	IOPS	IOPS   MB/s	IOPS   MB/s
Advantages	Performance due to parallel operation of the access	Performance as multiple requests can be fulfilled simultaneously	Good for reads, small IOPS, many concurrent IOPS and random I/Os. Parity utilizes small portion of raw capacity.	Same advantages as RAID-5 but with better data protection. Two hard drives can fail without losing access to data.
Disadvantages	No redundancy. One physical disk fails, data is lost	Storage costs are doubled	Writes are particularly demanding	Overhead on writes will be slightly more demanding than RAID-5

### Virtual Disk Configuration

A virtual disk is a logical structure on a storage array for data storage. A virtual disk is created by slicing a disk group into a stripe set with a defined capacity. Each disk group supports up to one or more virtual disks and a maximum of 256 virtual disks per MD3200 series of storage system. During the virtual disk creation process, the user specifies the capacity of the virtual disk and the virtual disk name. Additional settings include preferred controller ownership and a virtual disk-to-LUN mapping parameter (See Storage Partitioning section).





## Configuration Metadata

MD3200 series of controllers store configuration metadata in a private 512 MB region on every configured physical disk. This metadata area contains physical disk state and status information, virtual disk state and status information and controller and subsystem information. The metadata on each physical disk stores that physical disk's state and status, the worldwide name of its disk group, the virtual disks it contains and the definitions for those virtual disks. Additionally, one physical disk in each disk group (with a minimum of three in each storage system) stores the controller- and subsystem-level information.

Storing metadata in this nonvolatile region provides the highest availability and enables easier reconfigurations and migrations. As system configuration data resides on every configured physical disk, controllers and/or multiple physical disks can be removed or swapped without losing the system configuration. Physical disks can be relocated within the storage system to improve channel utilization/protection or even migrated as a complete disk group into another storage system. In instances, all configuration metadata and user data remains intact on the physical disks.

## Global Hot Spares

If a physical disk fails in the MD3200 or MD3220 storage array, the controller uses redundancy data to reconstruct the data onto a hot spare physical disk. The hot spare is automatically substituted for the failed physical disk without requiring user intervention. Once the failed drive is replaced, the data is then automatically copied back to the new drive. The user then has a choice of allowing the hot spare to return to its role as a hot spare drive or become a permanent member of a disk group, therefore, eliminating the copy back process. The replacement drive, in this case, would then be in an unassigned state. This feature may be appealing as it reduces the degraded mode time by avoiding the copy back process. The MD3200 and MD3220 storage arrays both support an unlimited number of global hot spare physical disks, and each can be a spare for any like-technology disk in the array (i.e. SAS for SAS, near-line SAS for near-line SAS and SSD for SSD). Generally speaking, the physical disks that are assigned as a hot spares should have a capacity that is equal to or greater than the capacity of the largest physical disk in the storage array.

## Storage Partitioning

The MD3200 series of arrays Storage Partitioning feature enables a single storage array to be logically partitioned and function as up to 8 virtual arrays. A storage partition is a logical entity consisting of one or more virtual disks that are accessed by a single host or shared among a collection of hosts that are part of a host group. A storage partition is created when one or more virtual disks are mapped to an individual host or host group. This virtual disk-to-LUN mapping allows you to define what host or host group will have access to a particular virtual disk in your storage system. Hosts and host groups can only access data through assigned virtual disk-to-LUN mappings. Partition access is maintained at the controller level, ensuring complete data integrity in multi-host, multi-OS environments.

The virtual disk-to-LUN mapping implementation creates valuable flexibility for the storage administrator as any available virtual disk can be mapped to any attached server. So, while the individual servers see a virtual array that consists of only their LUNs/virtual disks, the virtual disks can be intermixed throughout the storage system within one or more disk groups.

The system's logical partitioning combined with its configuration capabilities enables administrators to choose from a range of virtual disks with different characteristics to meet a server's exact needs for a given

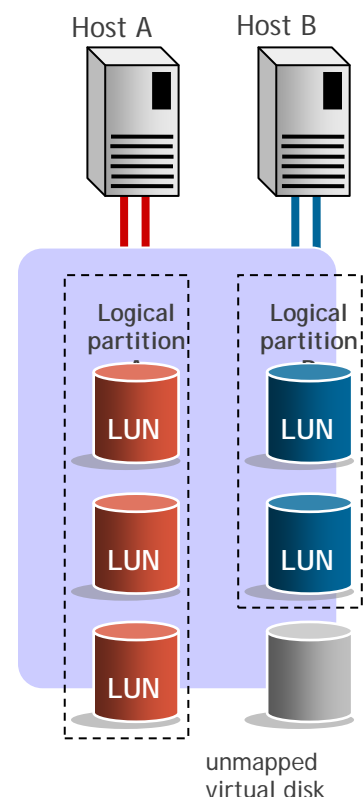

application. A given host can concurrently have virtual disks with different capacities, different RAID levels, and different physical disk types. This flexibility enables hosts with different capacity, performance or data protection demands to effectively share a single storage array.

## Snapshot

The MD3200 series of arrays Snapshot functionality provides an additional level of data protection and the means to improve production data utilization.

Snapshot enables non-production servers to access an up-to-date copy of production data for a variety of applications - including backup, application testing, or data mining - while the production data remains online and user-accessible.

A snapshot is a point-in-time image of a source virtual disk. It is the logical equivalent of a complete physical copy, but is created much more quickly and requires less disk space. Snapshots appear and function as standard virtual disks; they are host-addressable and can be read, written to or copied.

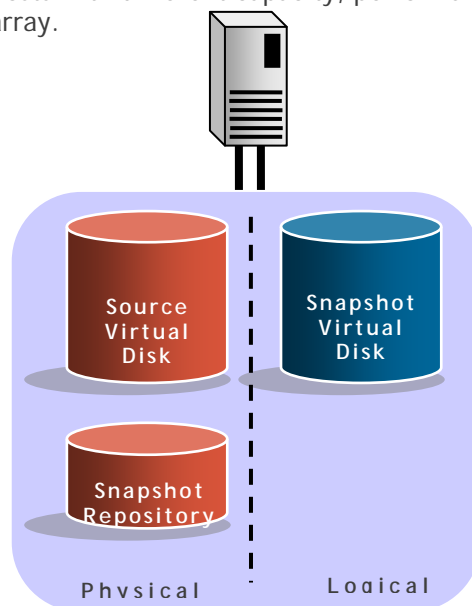

Snapshot uses an innovative copy-on-write technology to maintain the logical snapshot virtual disk while minimizing disk utilization. When the snapshot is “taken,” the controller suspends I/O to the source virtual disk for a few seconds while it creates a new physical virtual disk - called the repository virtual disk - to store snapshot metadata and copy-on-write data. When a data block on the source virtual disk is modified, a copy-on-write occurs, copying the contents of blocks that are to be modified into the repository virtual disk for safekeeping. This repository virtual disk combined with the original source virtual disk creates the logical snapshot virtual disk.

Since the only data blocks that are physically stored in the repository virtual disk are those that have changed since the time of the snapshot, the snapshot technology uses less disk space than a full physical copy. The repository virtual disk is typically 20 percent of the base virtual disk, but will vary depending on the amount of changes to the data. The longer a snapshot is active, the larger the repository is needed. Virtual disk snapshot provides notification when the repository virtual disk nears a user-specified threshold (a percentage of its full capacity). And at any time, the volume expansion feature can be used to dynamically expand the repository virtual disk.

## Virtual Disk Copy

The MD3200 series of arrays Virtual Disk Copy functionality provides administrators with another tool to effectively manage information growth and maximize the utilization of the storage array. Virtual disk copy creates a complete physical copy, or a clone, of a virtual disk within a storage array. The clone virtual disk is a unique entity that can be assigned to any host and used by applications requiring a point-in-time (PiT) copy of production data - such as backup, application testing or development, information analysis or data mining - without affecting the performance of the production virtual disk.

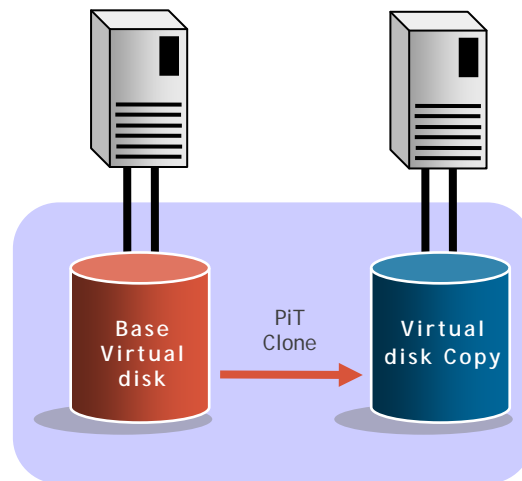

Virtual disk copy is configured and accessed via easy-to-use wizards. It supports up to eight concurrent copies taking place within a single array. Virtual disk copy is a

background operation with five user-defined priority settings, enabling administrators to minimize either copy time or the overall I/O impact to the storage system. As virtual disk copy is controller based, it requires no host interaction or CPU cycles - minimizing the impact to applications and the storage infrastructure.

Virtual disk copy can be used in conjunction with virtual disk snapshot - which creates a PiT image of a virtual disk while maintaining read / write access - enabling a complete PiT clone to be created without interrupting the I/O activity of the production virtual disk. Additionally, virtual disk copy can be used to redistribute data - moving virtual disks from older, slower disk physical disks to newer, faster, or higher capacity physical disks - to optimize application performance and/or capacity utilization.

## Online Administration

The MD3200 series of storage arrays allows primary storage management tasks to be performed while the storage remains online with complete read/write data access. This allows storage administrators to make configuration changes, conduct maintenance, or expand the storage capacity without disrupting I/O to its attached hosts. Online capabilities include:

### Add Free Capacity

Capacity Expansion enables the capacity and number of physical disks to be increased for a given disk group. Up to two physical disks at a time can be added to existing disk groups, with the existing virtual disks then being striped across the full set of physical disks now comprising the disk group.

### Dynamic Expansion

This feature enables new drive modules to be added, virtual disk groups to be configured, and virtual disks to be created without disrupting access to existing data. Once a newly created virtual disk is defined, the array provides immediate virtual disk availability and is enable it to be instantly mapped and accessed by a host(s).

### Dynamic Virtual Disk Expansion

This feature allows for the capacity expansion of an existing virtual disk by using the free capacity on an existing virtual disk group. And since dynamic virtual disk expansion concatenates (combines) the new capacity with the original capacity, maximum performance and utilization is assured.

### Dynamic RAID Level Migration

This level of migration changes the RAID level of a virtual group on the existing drives, without requiring the relocation of data. With this dynamic feature, customers can easily adjust RAID levels when their application, availability, or performance needs change.

### Dynamic Segment Size Migration

With this feature, the segment size of a given virtual disk can be dynamically changed.

### Dynamic Defragmentation

Dynamic defragmentation allows the user to rearrange virtual disks and consolidates free capacity within a virtual disk group resulting in optimized access patterns for existing and newly created volumes.

### Non-disruptive firmware upgrades

Enables controller firmware upgrades to occur with no interruption to data access. The new firmware is

transferred to the first controller, its flash memory is updated, and the controller is rebooted. The firmware is then passed from the first controller to the second, and the process is repeated. With a multi-path driver installed, access to all storage arrays' virtual disks is maintained throughout the process.

## Host Operating System Support

The MD3200 series of storage arrays support the following operating systems:

Microsoft Windows 2008

Microsoft Windows 2003

Microsoft Hyper-V

RedHat Enterprise Linux

SuSE Enterprise Linux

VMware

Xen Server (RTS+)

Please consult with the MD3200/MD3220 Support Matrix for a complete list of supported configurations.

**Table 8. Supported Servers**

R910	R410
R905	R210
R900	PE2970
R815	PE2950 III
R810	PE1950 III
R805	T710
R715	T610
R710	T410
R610	T310
R510	PE2900 III

Please consult with the MD3200/MD3220 Support Matrix for the most up to date list of supported servers.

## Environmental

### Power Supply Specs

The PowerVault™ MD3200 and MD3220 power supply is rated at 600 W. It operates on input voltages ranging from 100 - 240 V, auto-switching to the sensed line level.

EMC classification is Light Industry

FCC classification is Class A

**Table 9. Power Supply Specifications**

AC Characteristics									
INPUT PARAMETER	Requirement								
Input Voltage Range	90 - 264 VAC								
Input Frequency	47 - 63 Hz								
Peak Inrush Current	55 A for 10ms or less, 25 A for 10-150ms								
Power Factor over full AC input range	0.9 @ output load > 90%								
Minimum Efficiency measured 20%, 50% and 80% output load over full range of AC input and environmental conditions	Must Meet Climate Savers requirements: <table border="1" data-bbox="885 976 1380 1228"> <thead> <tr> <th>Load Condition</th> <th>Efficiency</th> </tr> </thead> <tbody> <tr> <td>20%</td> <td>87%</td> </tr> <tr> <td>50%</td> <td>90%</td> </tr> <tr> <td>100%</td> <td>87%</td> </tr> </tbody> </table>	Load Condition	Efficiency	20%	87%	50%	90%	100%	87%
Load Condition	Efficiency								
20%	87%								
50%	90%								
100%	87%								
Peak Output Power	600 Watts								

### Thermal management

The cooling system for the enclosure is designed to allow all components (power supplies, RAID controllers, HDDs, SSDs etc.) to meet their full operating specifications. There may be up to four fans in each power supply/fan module. This configuration provides N+1 fan redundancy, meaning that the enclosure can be sufficiently cooled for normal operation even if one fan fails.

Firmware shall continuously monitor the temperature sensors within the enclosure and take proper actions to throttle the fans in order to maintain optimal operating temperature.

### Over-Temperature Shutdown

In order to prevent potential damage to the drives and subsequent loss of data, the power supply has the capability to shut itself down or be shut down by the RAID controllers in the event of an over-temperature condition. When the power supply incorporates its internal thermal shutdown feature, it will automatically restart when the over temperature condition no longer exists. Hysteresis of at least 5 degrees is employed to prevent a frequent toggling on and off of the outputs.

**Table 10. Environmental Specifications**

<b>Temperature</b>	
Operating	10° to 35°C (50° to 95°F) with a maximum temperature gradation of 10°C per hour Note: For altitudes above 2950 feet, the maximum operating temperature is de-rated 1°F/550 ft.
Storage	-40° to 65°C (-40° to 149°F) with a maximum temperature gradation of 20°C per hour
<b>Relative Humidity</b>	
Operating	20% to 80% (non-condensing) with a maximum humidity gradation of 10% per hour
Storage	5% to 95% (non-condensing) with a maximum humidity gradation of 10% per hour
<b>Maximum Vibration</b>	
Operating	0.25 G at 3 – 200 Hz for 15 min
Storage	0.5 at 3 – 200 Hz for 15 min
<b>Maximum Shock</b>	
Operating	One shock pulse in the positive z axis (one pulse on each side of the system) of 31 G for 2.6 ms in the operational orientation
Storage	Six consecutively executed shock pulses in the positive and negative x, y, and z axes (one pulse on each side of the system) of 71 G for up to 2 ms
<b>Altitude</b>	
Operating	-16 to 3048 m (-50 to 10,000 ft) Note: For altitudes above 2950 feet, the maximum operating temperature is de-rated 1°F/550 ft.
Storage	-16 to 10,600 m (-50 to 35,000 ft)
<b>Airborne Contaminant Level</b>	
Class	G2 or lower as defined by ISA-S71.04-1985

## Configuration Guidelines

### General Configuration Rules

The MD3200 and MD3220's extensive configuration flexibility enables customized performance tuning, maximum capacity utilization and the highest data protection to support application servers with vastly different requirements. A single storage array can concurrently support multiple RAID levels (0, 1, 5, 10 and 6), multiple drive technologies (SSD, SAS and near-line SAS), multiple and various disk group sizes, and one or more virtual disks per disk group.

Below are general configuration rules for MD3200 series of arrays.

Up to 8 direct attached servers with single I/O paths to a dual controller storage array

Up to 4 direct attached servers with redundant I/O paths to a dual controller storage array

Up to 96 total drives consisting of SSD, SAS and/or near-line SAS drives per storage system

SSD drives are limited to a single shelf (12 drives for a MD3200 or 24 drives for a MD3220)

MD1200 and/or MD1220 storage enclosures can be add to a MD3200 or MD3220 storage array for expansion up to 96 total hard drives

Up to 30 hard disk drives per disk group in a RAID 5 and RAID 6

Up to 96 hard disk drives per disk group in a RAID1/10

Each disk group can be configured as RAID level 0, 1, 5, 10 or 6.

Disk groups with different RAID levels can coexist in a single storage system.

Disk groups are comprised of either SSD or SAS drives. A given disk group cannot have both SSD and SAS drives.

Up to 256 virtual disks (LUNs) per storage array

Each virtual disk can support 8 snapshots, with a maximum of 128 snapshots per storage array.