

# PCS CDMA LNA / Downconverter 1.80 - 2.0 GHz

MD59-0049

## Features

- High Integrated LNA and Downconverter
- Operates over 2.7 V to 5V Supply Voltage
- Low Noise Figure, 2.3 dB Typical
- High Input Intercept Point
- Continuous Current Control Downconverter
- Continuous Gain Control Downconverter
- Low LO Drive Level -10 dBm
- Miniature MLF - 4 mm Plastic Package

## Description

M/A-COM's MD59-0049 integrated downconverter combines a low noise amplifier, RF amplifier, mixer, IF amplifier, and LO buffer in a miniature 4 millimeter plastic MLF package that has an exposed backside for improved high frequency grounding.

M/A-COM designed the MD59-0049 for applications requiring high linearity wide dynamic range and low power consumption. By application of a suitable control voltage to pin 13, the linearity of the device can be controlled in real time to keep the current as low as possible.

M/A-COM fabricates the MD59-0049 using a 0.5 micron low noise E/D GaAs MESFET process. The process features full passivation for increased performance and reliability.

## Recommended PCB Configuration

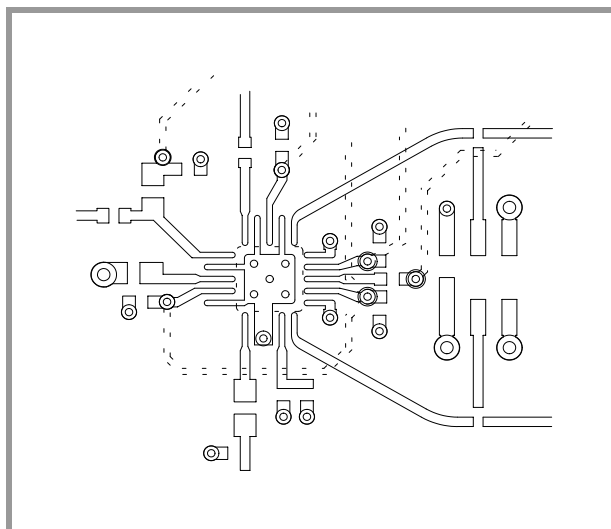

## Functional Schematic

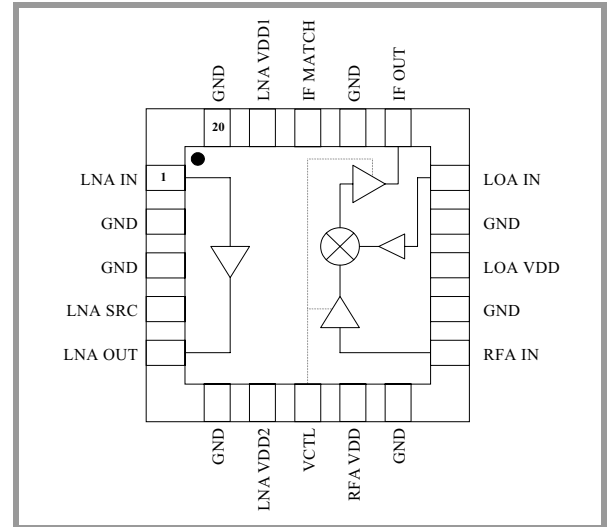

## Pin Configuration

PIN No.	PIN Name	Description
1	LNA IN	RF input to LNA. External matching required.
2	GND	DC and RF ground
3	GND	DC and RF ground
4	LNA SRC	Source of LNA output stage FET. RF bypassing required. Off-chip resistor may be used to increase IP <sub>3</sub> .
5	LNA OUT	50Ω output of LNA. DC-blocked
6	GND	DC and RF ground
7	LNA V <sub>DD2</sub>	LNA stage 2 supply voltage. RF bypassing required.
8	V <sub>CTRL</sub>	Downconverter bias control. 0 - 3V control voltage allowed.
9	RFA V <sub>DD</sub>	RFA supply voltage. RF bypassing required.
10	GND	DC and RF ground.
11	RFA IN	50Ω input and RFA. DC-blocked.
12	GND	DC and RF ground
13	LOA V <sub>DD</sub>	LO amplifier supply voltage. RF bypassing required.
14	GND	DC and RF ground
15	LOA IN	Local oscillator input (-10 to -5 dBm)
16	IF OUT	IF output of downconverter - must be externally matched to input impedance of IF filter.
17	GND	DC and RF ground
18	IF MATCH	Matching between IFA and Mixer—requires an inductor to ground.
19	LNA V <sub>DD1</sub>	LNA stage 1 supply voltage. RF bypassing required.
20	GND	DC and RF ground.

**Electrical Specifications**  $T_A = +25^\circ\text{C}$ ,  $V_{DD} = 3.0\text{V}$ ,  $R_F = 1.96\text{ GHz}$ ,  
 $I_F = 210\text{ MHz}$ ,  $LO = -10\text{ dBm}$

Parameter	Test Conditions	Units	Min.	Typ.	Max.
<b>Low Noise Amplifier</b>					
Gain		dB		15	
Noise Figure		dB		1.5	
$V_{\text{SWR}}$ In/Out				2:1	
Input $IP_3$		dBm		+6	
IDD		mA		13	
<b>Complete DownConverter<sup>1</sup></b>					
Conversion Gain	$V_{\text{cont}} = 1.0 \sim 3.0\text{V}$	dB		7~13	
Noise Figure	$V_{\text{cont}} = 1.0 \sim 3.0\text{V}$	dB		7~5.5	
Input $IP_3$	RF Input = -30 dBm, $V_{\text{cont}} = 1.0 \sim 3.0\text{V}$	dBm		3~8	
LO-to-RF Isolation	$V_{\text{cont}} = 3.0\text{V}$	dB		12	
LO-to-IF Isolation	$V_{\text{cont}} = 3.0\text{V}$	dB		20	
RF-to-IF Isolation	$V_{\text{cont}} = 3.0\text{V}$	dB		20	
$I_{DD}$	$V_{\text{cont}} = 1.0 \sim 3.0\text{V}$	mA		7~13	
<b>Cascade</b>					
Conversion Gain	$V_{\text{cont}} = 1.0 \sim 3.0\text{V}$	dB		19~25	
Noise Figure	$V_{\text{cont}} = 3.0\text{V}$	dB		2.3	
Input $IP_3$	RF Input = -30 dBm, $V_{\text{cont}} = 3.0\text{V}$	dBm		-8	
LO-to-RF Isolation	$V_{\text{cont}} = 3.0\text{V}$	dB		38	
LO-to-IF Isolation	$V_{\text{cont}} = 3.0\text{V}$	dB		20	
LNA-to-IF Isolation	$V_{\text{cont}} = 3.0\text{V}$	dB		10	
$I_{DD}$	$V_{\text{cont}} = 1.0 \sim 3.0\text{V}$	mA		20~26	

<sup>1</sup> Complete downconverter measurements taken with 3 dB pad between LNA output and RFA input.

Specifications subject to change without notice.

- North America: Tel. (800) 366-2266, Fax (800) 618-8883
- Asia/Pacific: Tel. +81-44-844-8296, Fax +81-44-844-8298
- Europe: Tel. +44 (1344) 869 595, Fax +44 (1344) 300 020

Visit [www.macom.com](http://www.macom.com) for additional data sheets and product information.

**tyco** / Electronics

**MACOM**

## Operating Instructions

The MD59-0049 is a highly integrated MMIC downconverter for the 1.8 - 2 GHz PCS band. The downconverter provides exceptional RF performance while drawing low DC current and is packaged in a low-cost plastic package. It is ideal for lightweight battery operated portable radio systems.

The MD59-0049 downconverter incorporates an LNA, RFA, single-ended mixer, and single-ended IF output buffer as shown in the block diagram. Surface mount resistors, inductors and capacitors are used in conjunction with the IC to optimize the trade-offs among performance, tunability and ease of use. The schematic on the previous page shows the IC and required off-chip components.

The input of the LNA is matched externally with a series inductor (L1) and a shunt capacitor (C1) to provide a low loss match to the optimum noise impedance in the band of interest. Use a high Q inductor such as Coilcraft's 0402CS series must to achieve the specified noise figures. The series capacitor C2 blocks DC and provides input matching. The LNA is nominally biased with 13 mA to give an input IP3 of + 6 dBm. You can use an external resistor, R1, to increase the LNA bias current and thus increase the IP3. An external image reject filter is required between the LNA output and RFA input to prevent downconversion of noise at the image frequency to the IF. This filter should have a 50  $\Omega$  input and output impedance.

The mixer is a single-ended floating FET mixer that provides exceptional linearity and isolation with low loss and no DC current. An off-chip inductor, L3, is required to match the output of the mixer to the input of the IF buffer amplifier. We recommend using an 0603 type inductor for L3 in most situations, but use an 0805 type if you require more gain. The IF output port is the open drain of the IF buffer amplifier. This allows maximum flexibility of intermediate frequency and also IF filter. You can use a matching network such as that shown on page 2 to match 50  $\Omega$  from the output impedance of the buffer to the input impedance of the filter at 210 - 220 MHz frequencies. The inductor also acts as a choke for the DC supply line.

The LO input port is matched on-chip to 50 $\Omega$ . An LO buffer amplifies the -10 dBm input signal to the level required to drive the mixer. For optimum performance, use a drive level of -5 dBm.

You must properly bypass all DC supply lines at RF frequencies to obtain optimum performance, and at lower frequency to maintain unconditional stability. Capacitors C4, C5, C6, C9, and C10 are RF bypass capacitors for the LNA, RFA and LOA. The values and placement of these capacitors is critical in determining the frequency response of these amplifiers. Capacitor C3 is a source bypass capacitor for the second stage of the low noise amplifier. The placement of this capacitor will affect the gain of the LNA. For best performance, place all the RF bypass capacitors as shown in the PCB drawing.

*Specifications subject to change without notice.*

- **North America:** Tel. (800) 366-2266, Fax (800) 618-8883
- **Asia/Pacific:** Tel.+81-44-844-8296, Fax +81-44-844-8298
- **Europe:** Tel. +44 (1344) 869 595, Fax+44 (1344) 300 020

Visit [www.macom.com](http://www.macom.com) for additional data sheets and product information.

**tyco** / Electronics

**MACOM**

Sample Board Schematic

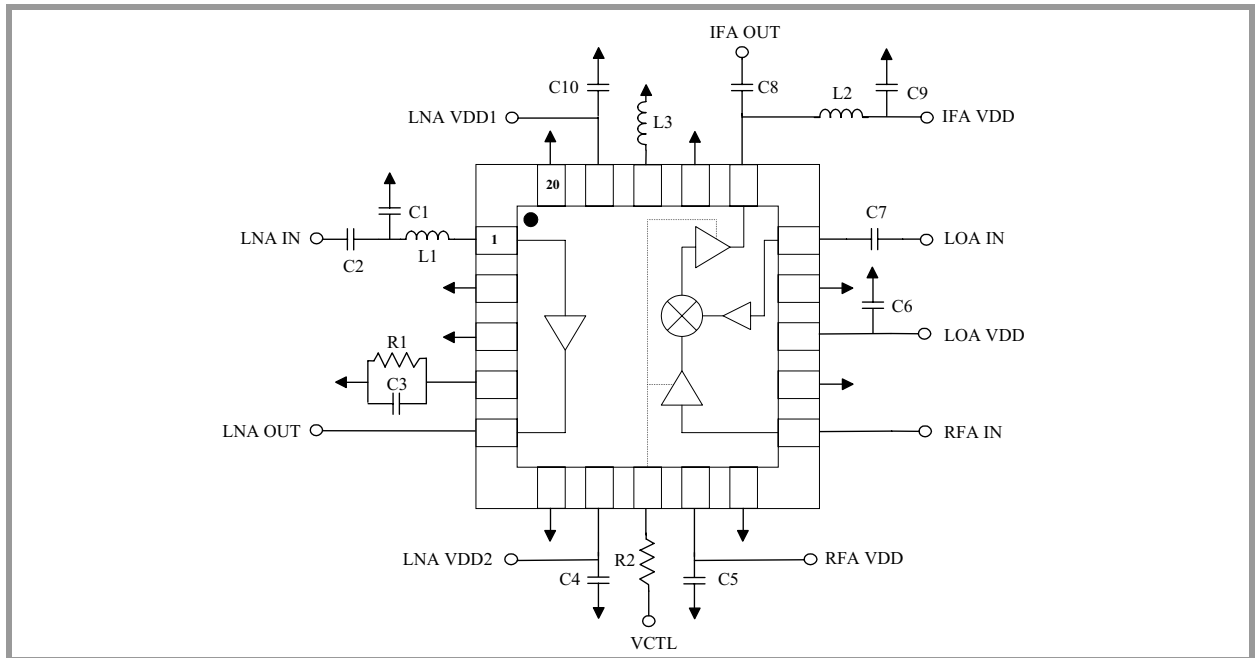

External Circuitry Parts List

Ref. Designation	Value	Purpose
L1	7.5nH	LNA Input matching
C2	4pF	LNA Input DC block
C3	100000pF	LNA Source bypass
C4, C5, C6, C9, C10	100000pF	RF Bypass
C1	0.5pF	LNA Bypass
R1		Optional resistor to increase LNA IP3
R2	3000Ω	Voltage control resistor
L2	47nH	IF matching
C8	10pF	IF matching
L3	120nH	IF matching

Specifications subject to change without notice.

- North America: Tel. (800) 366-2266, Fax (800) 618-8883
- Asia/Pacific: Tel.+81-44-844-8296, Fax +81-44-844-8298
- Europe: Tel. +44 (1344) 869 595, Fax+44 (1344) 300 020

Visit [www.macom.com](http://www.macom.com) for additional data sheets and product information.



## Typical Performance Curves

### LNA Standalone

**LNA Input Return Loss vs. Temperature**  
@ 25°C, 85°C, -30°C,  $V_{DD} = 3.0V$

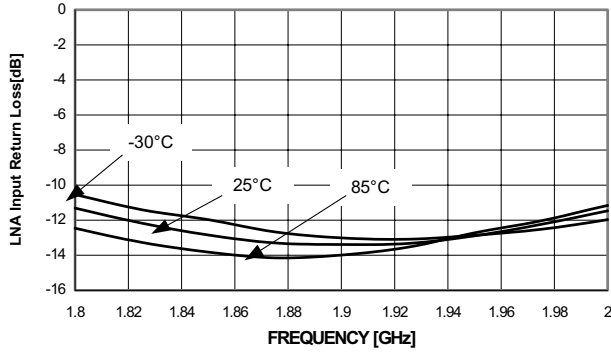

**LNA Input Return Loss vs.  $V_{DD}$**   
@ 25°C,  $V_{DD} = 2.7V, 3.0V, 3.3V$

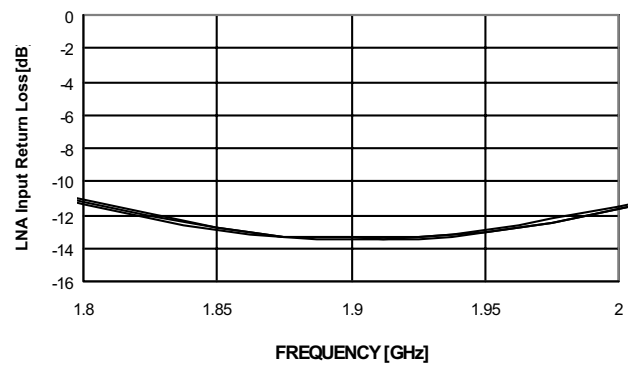

**LNA Gain vs. Temperature**  
@ 25°C, 85°C, -30°C,  $V_{DD} = 3.0V$

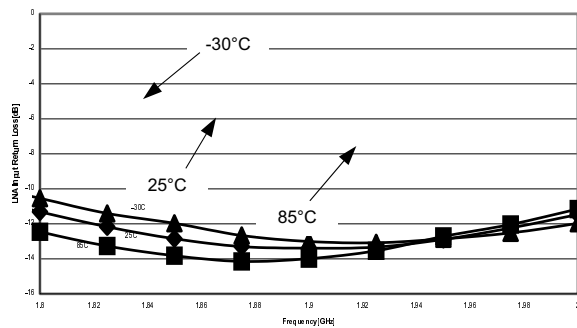

**LNA Gain vs.  $V_{DD}$**   
@ 25°C,  $V_{DD} = 2.7V, 3.0V, 3.3V$

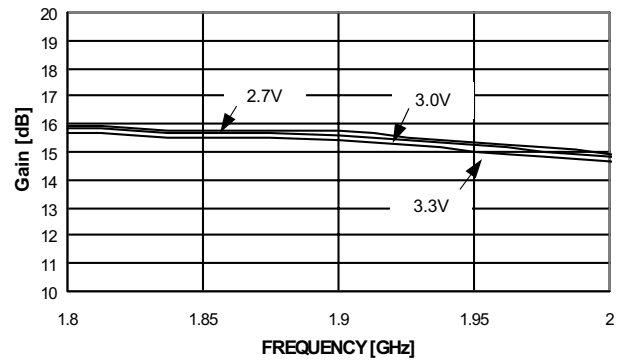

**LNA Output Return Loss vs. Temperature**  
@ 25°C, 85°C, -30°C,  $V_{DD} = 3.0V$

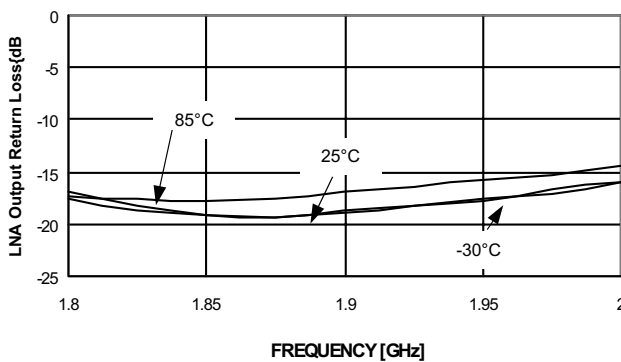

**LNA Output Return Loss vs.  $V_{DD}$**   
@ 25°C,  $V_{DD} = 2.7V, 3.0V, 3.3V$

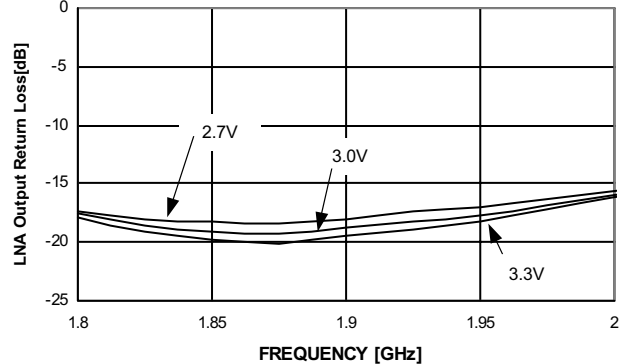

Specifications subject to change without notice.

- North America: Tel. (800) 366-2266, Fax (800) 618-8883
- Asia/Pacific: Tel.+81-44-844-8296, Fax +81-44-844-8298
- Europe: Tel. +44 (1344) 869 595, Fax+44 (1344) 300 020

Visit [www.macom.com](http://www.macom.com) for additional data sheets and product information.

Typical Performance Curves (Cont'd)

LNA Standalone (Cont'd)

LNA Noise Figure vs. Temperature  
@ 25°C, 85°C, -30°C,  $V_{DD} = 3.0V$

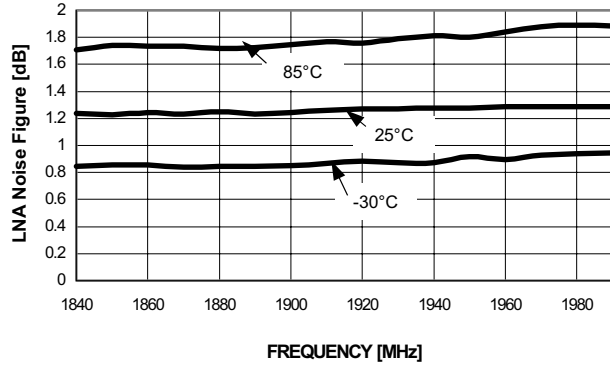

LNA Noise Figure vs.  $V_{DD}$   
@ 25°C,  $V_{DD} = 2.7V, 3.0V, 3.3V$

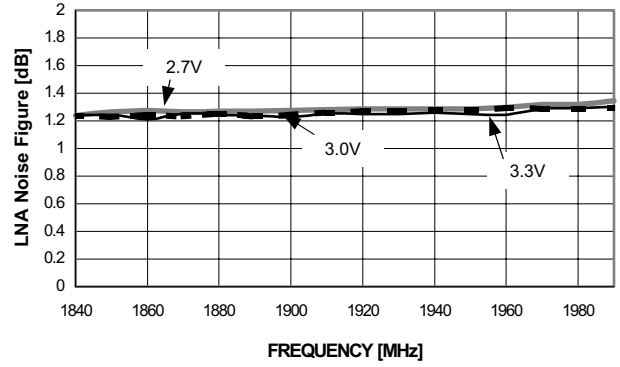

LNA Input  $IP_3$  vs.  $V_{DD}$  (Korean Band)  
 $V_{DD} = 2.7V, 3.0V, 3.3V, RF\ Input = -30\ dBm$

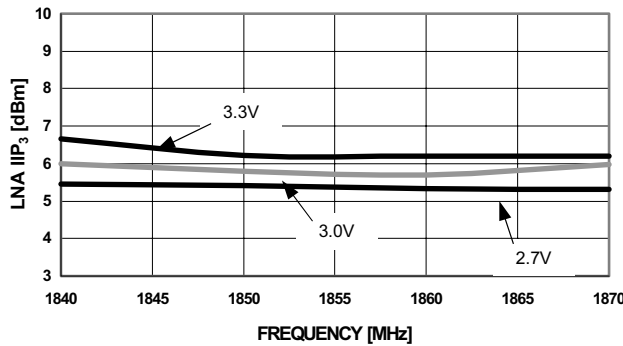

LNA Input  $IP_3$  vs.  $V_{DD}$  (US Band)  
 $V_{DD} = 2.7V, 3.0V, 3.3V, RF\ Input = -30\ dBm$

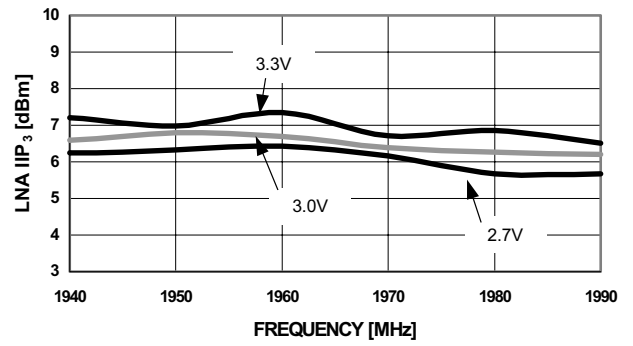

LNA Input  $IP_3$  vs. Temperature @ 25°C,  
85°C, -30°C,  $V_{DD} = 3.0V, RF\ Input = -30\ dBm$

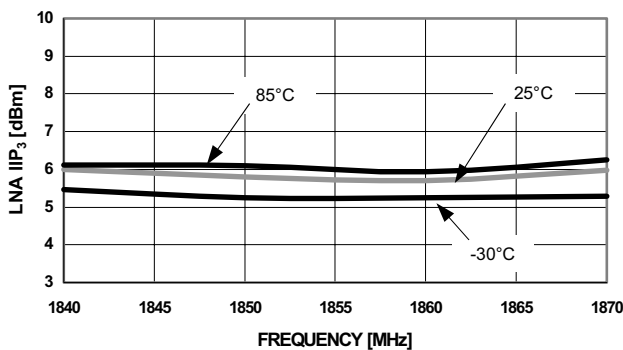

LNA Input  $IP_3$  vs. Temperature @ 25°C,  
85°C, -30°C,  $V_{DD} = 3.0V, RF\ Input = -30\ dBm$

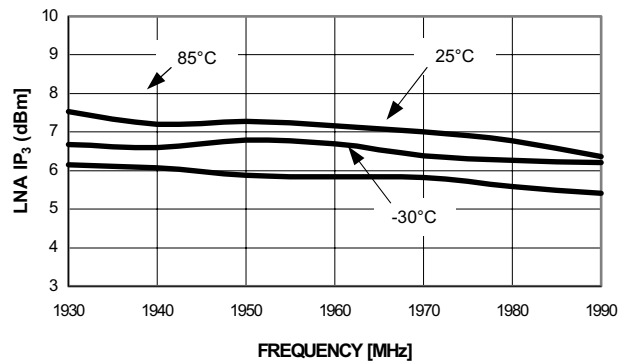

Specifications subject to change without notice.

- North America: Tel. (800) 366-2266, Fax (800) 618-8883
- Asia/Pacific: Tel.+81-44-844-8296, Fax +81-44-844-8298
- Europe: Tel. +44 (1344) 869 595, Fax+44 (1344) 300 020

Visit [www.macom.com](http://www.macom.com) for additional data sheets and product information.



Typical Performance Curves (Cont'd)

LNA Standalone (Cont'd)

LNA Input IP<sub>3</sub> vs. V<sub>DD</sub>, RF Input = -30 dBm  
@ 25°C, V<sub>DD</sub> = 2.7V, 3.0V, 3.3V

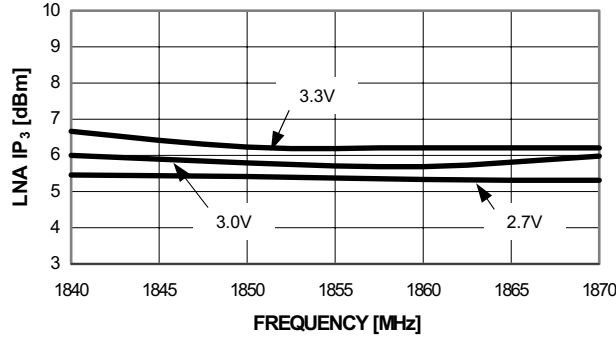

LNA Input IP<sub>3</sub> vs. V<sub>DD</sub>, RF Input = -30 dBm  
@ 25°C, V<sub>DD</sub> = 2.7V, 3.0V, 3.3V

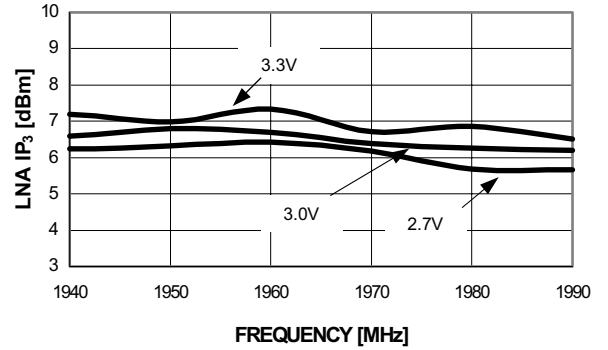

Downconverter Standalone

Downconverter RF Input Return Loss vs. Temperature @ 25°C, 85°C, -30°C,  
V<sub>DD</sub> = 3.0V, V<sub>CTRL</sub> = 3.0V

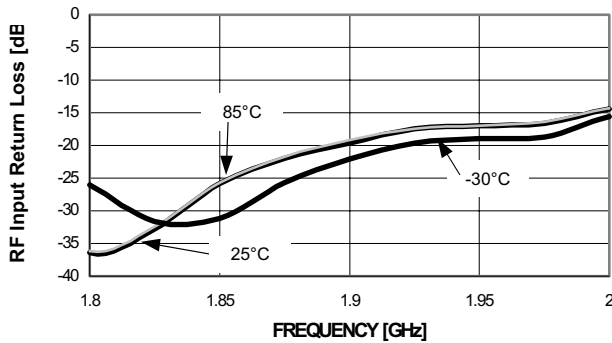

Downconverter RF Input Return Loss vs. V<sub>DD</sub>  
@ 25°C, V<sub>DD</sub> = 3.0V, 3.3V  
V<sub>CTRL</sub> = 3.0V

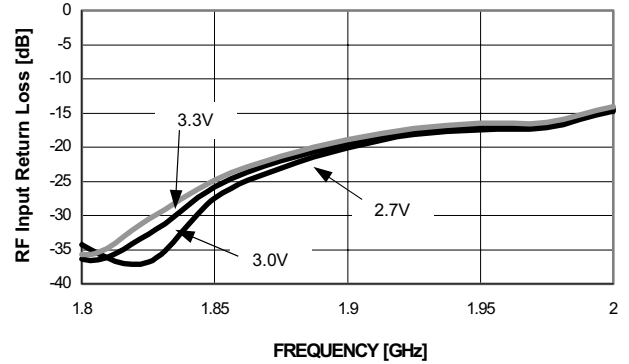

Downconverter LO Input Return Loss vs. Temperature @ 25°C, 85°C, -30°C, V<sub>DD</sub> = 3.0V

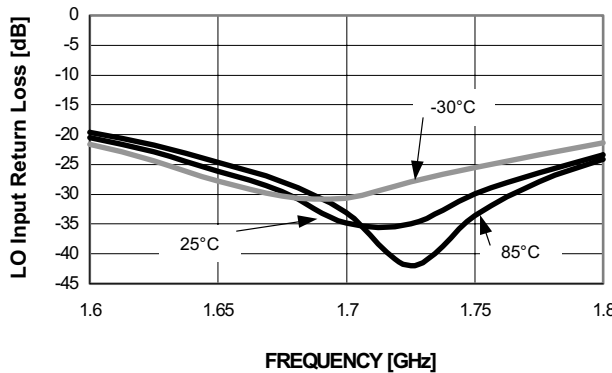

Downconverter LO Input Return Loss vs. V<sub>DD</sub>  
Temperature @ 25°C, V<sub>DD</sub> = 2.7V, 3.0V, 3.3V

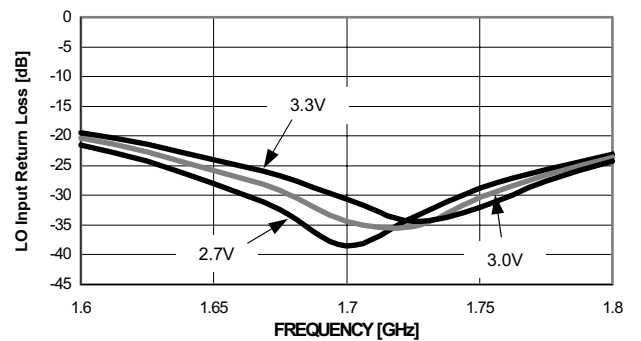

Specifications subject to change without notice.

- North America: Tel. (800) 366-2266, Fax (800) 618-8883
- Asia/Pacific: Tel.+81-44-844-8296, Fax +81-44-844-8298
- Europe: Tel. +44 (1344) 869 595, Fax+44 (1344) 300 020

Visit [www.macom.com](http://www.macom.com) for additional data sheets and product information.



Typical Performance Curves (Cont'd)

Downconverter Standalone (Cont'd)

Downconverter IF Output Return Loss  
Temperature @ 25°C, 85°C, -30°C,  
 $V_{DD} = 3.0V, V_{CTRL} = 3.0V$

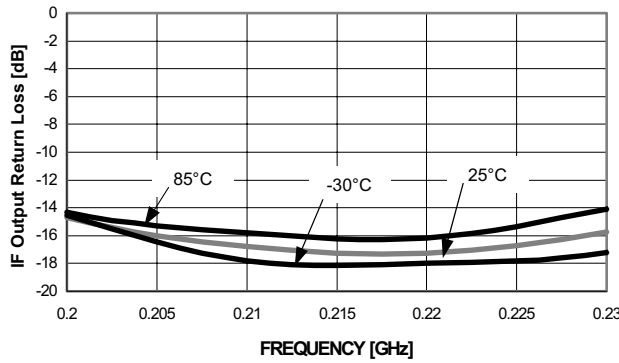

Downconverter IF Output Return Loss vs.  $V_{DD}$   
Temperature @ 25°C,  $V_{DD} = 2.7V, 3.0V, 3.3V,$   
 $V_{CTRL} = 3.0V$

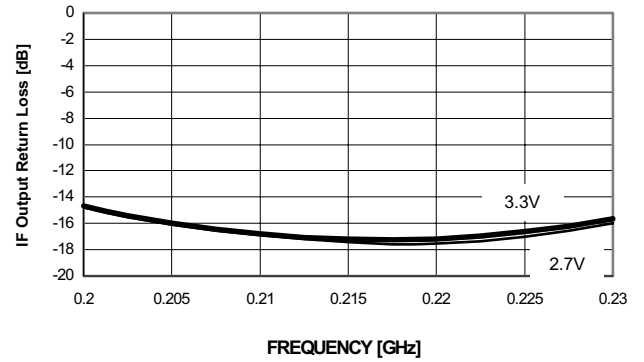

Downconverter Noise Figure vs.  $V_{DD}$   
Temperature @ 25°C,  $V_{DD} = 2.7V, 3.0V, 3.3V,$   
 $V_{CTRL} = 3.0V, LO = -10 dBm$

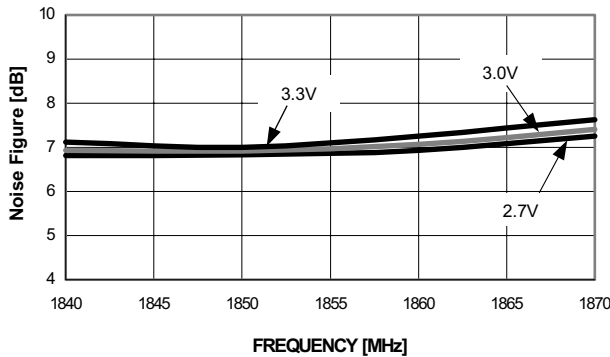

Downconverter Noise Figure vs.  $V_{DD}$   
Temperature @ 25°C,  $V_{DD} = 2.7V, 3.0V, 3.3V,$   
 $V_{CTRL} = 3.0V, LO = -10dBm$

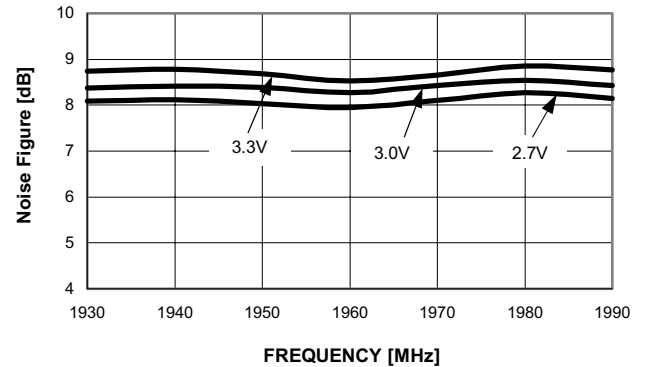

Downconverter Input  $IP_3$  vs. Temperature  
@ 25°C, 85°C, -30°C,  $V_{DD} = 3.0V, V_{CTRL} = 3.0V,$   
RF Input = -30 dBm, LO = -10 dBm

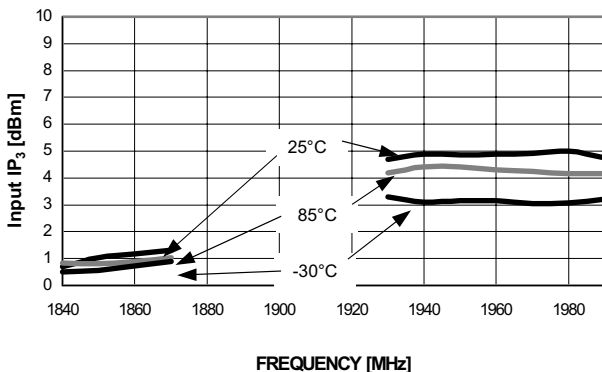

Downconverter Input  $IP_3$  vs.  $V_{DD}$   
Temperature @ 25°C,  $V_{DD} = 2.7V, 3.0V, 3.3V,$   
 $V_{CTRL} = 3.0V, RF Input = -30dBm, LO = -10dBm$

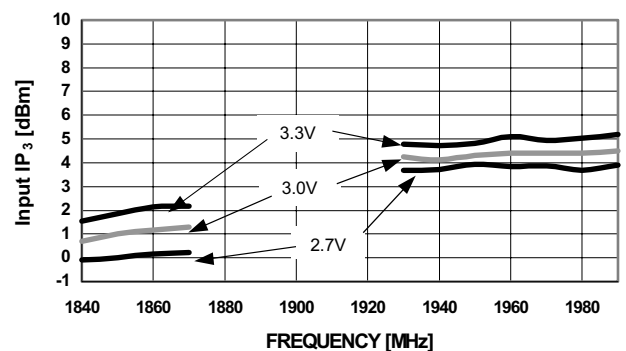

Specifications subject to change without notice.

- North America: Tel. (800) 366-2266, Fax (800) 618-8883
- Asia/Pacific: Tel.+81-44-844-8296, Fax +81-44-844-8298
- Europe: Tel. +44 (1344) 869 595, Fax+44 (1344) 300 020

Visit [www.macom.com](http://www.macom.com) for additional data sheets and product information.



Typical Performance Curves (Cont'd)

Downconverter Standalone (Cont'd)

Downconverter Input  $IP_3$  vs.  $V_{DD}$   
 Temperature @ 25°C,  $V_{DD} = 2.7V, 3.0V, 3.3V$ ,  $V_{CTRL} = 3.0V$ , RF Input = -30 dBm,  
 LO = -10dBm, -5 dBm

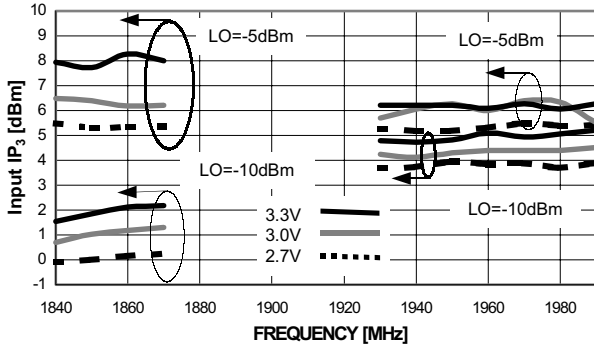

Full Chain Noise Figure with 3 dB PAD  
 $V_{DD} = 2.7V, 3.0V, 3.3V$ ,  $V_{CTRL} = 3.0V$ ,  
 LO = -10 dBm

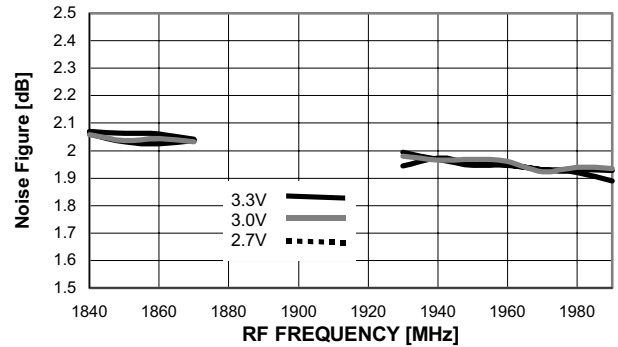

Full Chain Input  $IP_3$  with 3 dB PAD  
 Temperature @ 25°C,  $V_{DD} = 2.7V, 3.0V, 3.3V$ ,  
 LO = -10 dBm, RF Input = -30 dBm

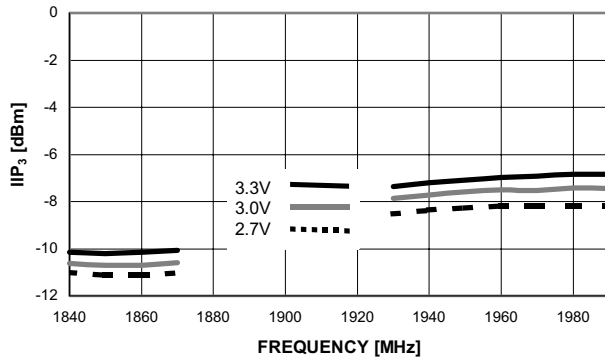

Full Chain  $IP_3$  with 3 dB PAD  
 Temperature @ 25°C,  $V_{DD} = 2.7V, 3.0V, 3.3V$ ,  
 LO = -5 dBm, RF Input = -30 dBm

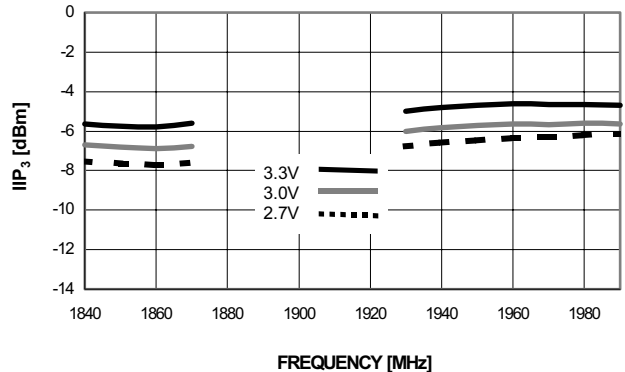

Specifications subject to change without notice.

- North America: Tel. (800) 366-2266, Fax (800) 618-8883
- Asia/Pacific: Tel.+81-44-844-8296, Fax +81-44-844-8298
- Europe: Tel. +44 (1344) 869 595, Fax+44 (1344) 300 020

Visit [www.macom.com](http://www.macom.com) for additional data sheets and product information.



4 mm MLF - 20

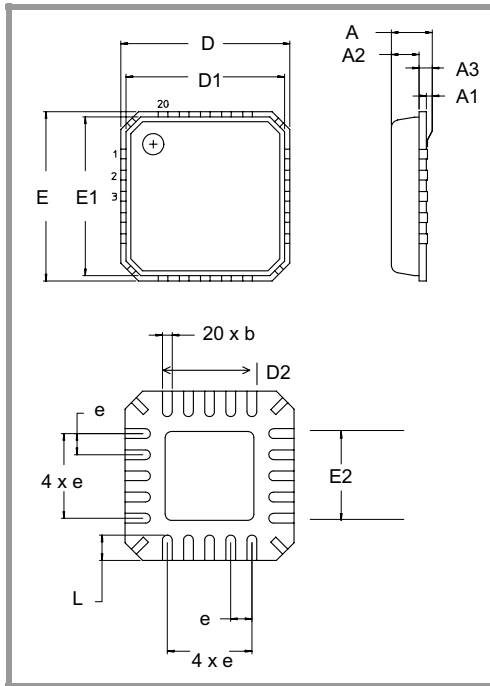

4 mm MLF - 20

Dim.	Measurement (mm)		
	Min.	Nom.	Max.
A	0.80	0.90	1.00
A1	0	0.02	0.05
A2	0	0.65	1.00
A3		0.25 ref.	
b	0.18	0.23	0.30
D		4.00 basic	
D1		3.75 basic	
D2	0.75	1.70	2.25
e		0.50 basic	
E		4.00 basic	
E1		3.75 basic	
E2	0.75	1.70	2.25
L	0.35	0.55	0.75

Ordering Information

Part Number	Package
MD59-0049	MLF-4.0 mm Plastic Package
MD59-0049TR	Forward Tape and Reel <sup>1</sup>
MD59-0049RTR	Reverse Tape and Reel <sup>1</sup>

<sup>1</sup> If specific reel size is required, consult factory for part number assignment.

Specifications subject to change without notice.

- North America: Tel. (800) 366-2266, Fax (800) 618-8883
- Asia/Pacific: Tel. +81-44-844-8296, Fax +81-44-844-8298
- Europe: Tel. +44 (1344) 869 595, Fax +44 (1344) 300 020

Visit [www.macom.com](http://www.macom.com) for additional data sheets and product information.

