

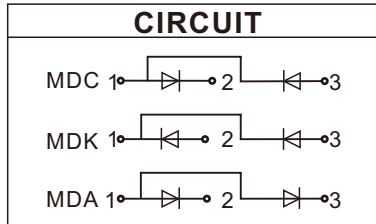

FEATURES

- Industrial Standard Package
- High Surge Current Capability
- Low Leakage Current
- Electrically Isolated by DBC Ceramic



APPLICATIONS

- Field Supply For DC Motors
- Various Rectifiers
- DC supply for PWM inverter

Module Type

Type			V _{RRM}	V _{RSM}	Unit
MDC600-08D4	MDK600-08D4	MDA600-08D4	800	900	V
MDC600-12D4	MDK600-12D4	MDA600-12D4	1200	1300	
MDC600-16D4	MDK600-16D4	MDA600-16D4	1600	1700	
MDC600-18D4	MDK600-18D4	MDA600-18D4	1800	1900	

ABSOLUTE MAXIMUM RATINGS

T_C=25°C unless otherwise specified

Symbol	Parameter	Test Conditions	Values	Unit
I _{F(AV)}	Average Forward Current	Single phase, half wave, 180°C conduction, T _C = 100°C	600	A
I _{F(RMS)}	R.M.S. Forward Current		942	
I _{FSM}	Non-Repetitive Surge Forward Current	1/2 cycle, 50HZ, peak value T _J =150°C	19.0	KA
		1/2 cycle, 60HZ, peak value T _J =150°C	20.3	
I ² t	I ² t(For Fusing)	1/2 cycle, 50HZ, peak value T _J =150°C	1805	KA ² S
		1/2 cycle, 60HZ, peak value T _J =150°C	1702	KA ² S
T _J	Junction Temperature		-40 to +150	°C
T _{STG}	Storage Temperature Range		-40 to +125	°C
V _{ISO}	Isolation Breakdown Voltage	AC, 50Hz(R.M.S), t=1minute	2500	V
Torque	Module-to-Sink	Recommended(M6)	6.0	N.m
Torque	Module Electrodes	Recommended(M10)	12.0	N.m
R _{th(J-C)}	Junction-to-Case Thermal Resistance		0.065	K /W
R _{th(C-H)}	Case-to-Heatsink Thermal Resistance		0.02	K /W
Weight			1500	g

ELECTRICAL AND THERMAL CHARACTERISTICS

T_C=25°C unless otherwise specified

Symbol	Parameter	Test Conditions	Min.	Typ.	Max.	Unit
I _{RRM}	Max.Reverse Leakage Current	V _R = V _{RRM} , T _J =150°C			40	mA
V _{FM}	Forward Voltage	I _F =2000A			1.45	V
V _{FO}	For power-loss calculations only				0.75	V
r _F	T _J =150°C				0.35	mΩ

CHARACTERISTIC CURVES

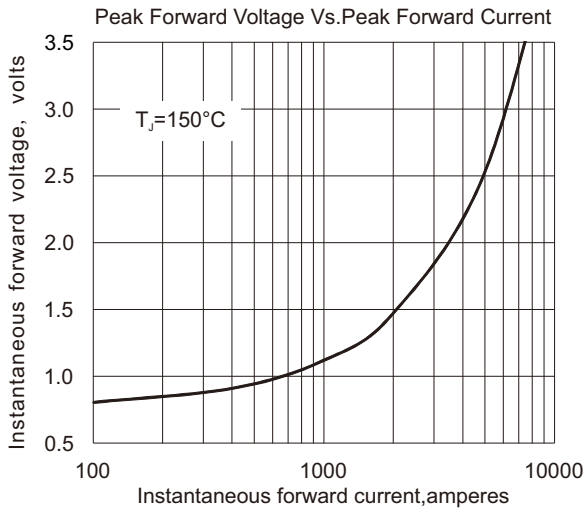

Fig.1

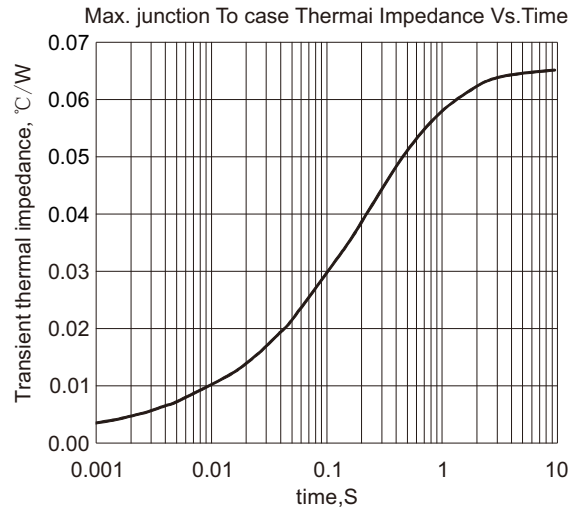

Fig.2

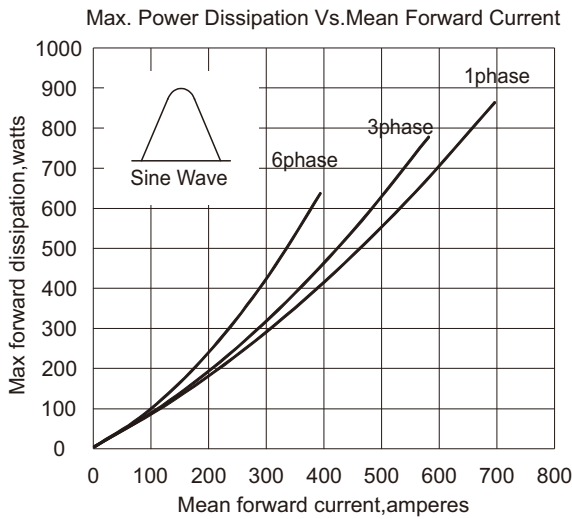

Fig.3

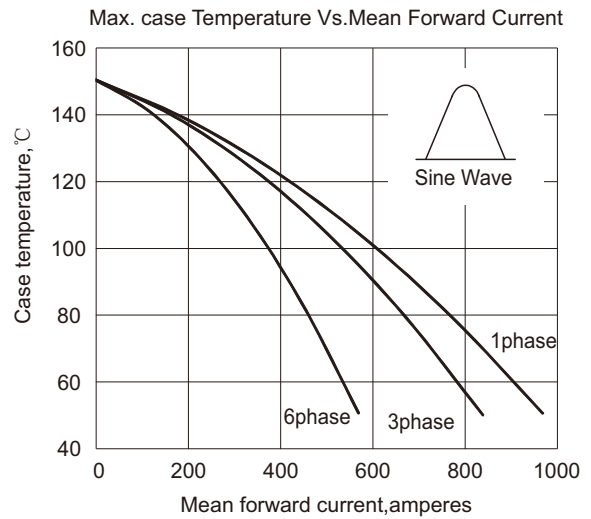

Fig.4

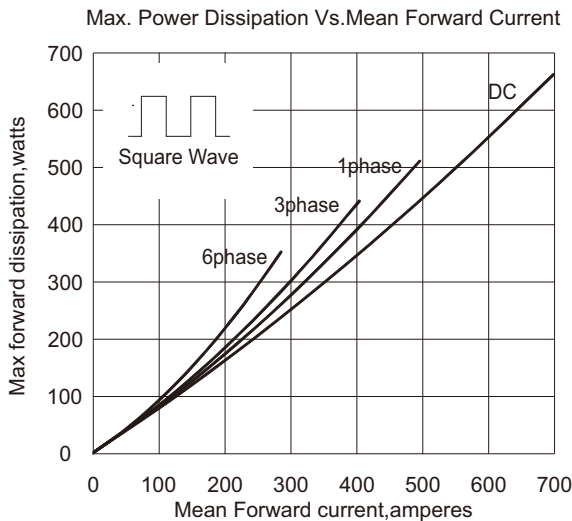

Fig.5

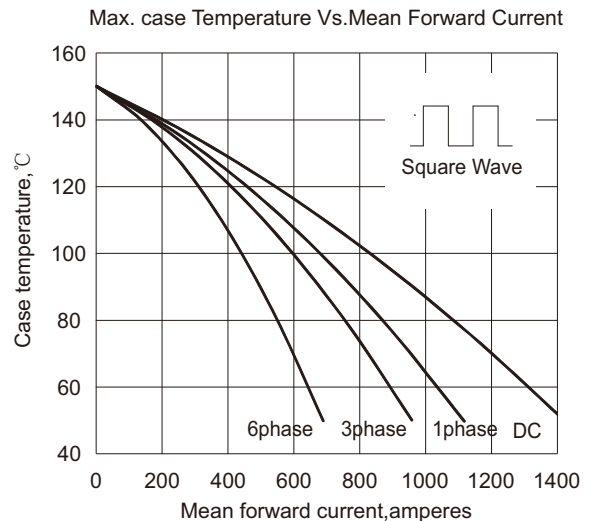

Fig.6

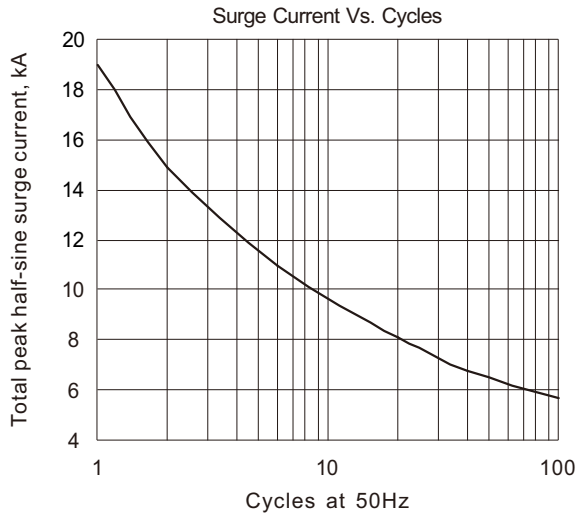

Fig.7

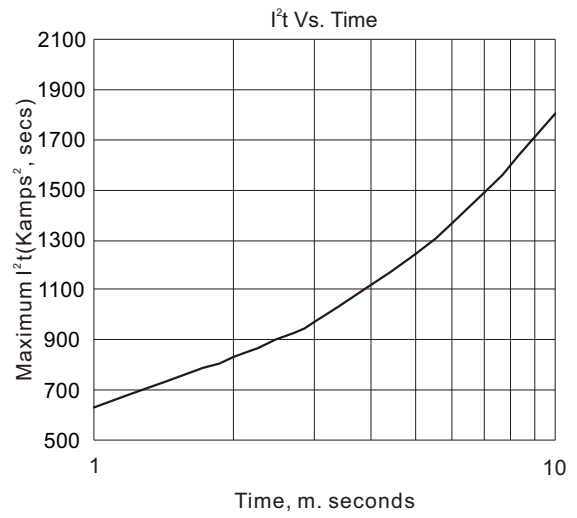
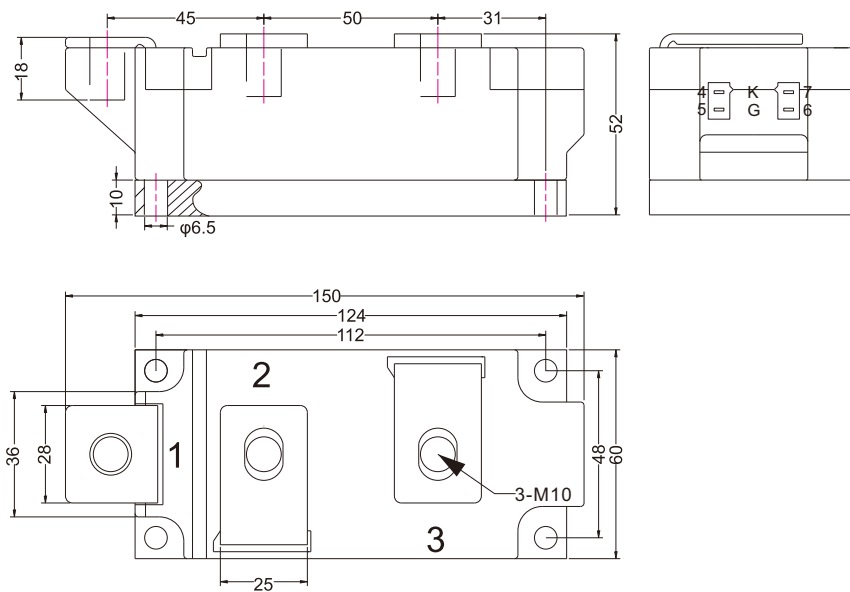

Fig.8

PACKAGE OUTLINE (DIMENSIONS IN MM)



weight: 1.5kg

ANSHAN HERUN ELECTRONICS CO., LTD

ADD: 8# Building, Tongzun Technology Park, No.296 Sifangtai Road,

Tiexi District, Anshan City, Liaoning Province, P. R. of China

Tel: +86-412-8727181 Fax: +86-412-8727180

E-mail: herune@163.com

Website: www.herunsemi.com