

Features :

- High performance thermal insulation materials
- Good thermal fatigue performance
- International standard package

Typical Applications

- Various rectifiers
- DC supply for PWM inverter

V_{RSM}	V_{RRM}	Type & Outline
900V	800V	MDx100-08
1100V	1000V	MDx100-10
1300V	1200V	MDx100-12
1500V	1400V	MDx100-14
1700V	1600V	MDx100-16
1900V	1800V	MDx100-18

SYMBOL	CHARACTERISTIC	TEST CONDITIONS	$T_j(^{\circ}C)$	VALUE			UNIT
				Min	Type	Max	
$I_{F(AV)}$	Mean forward current	180° half sine wave 50Hz Single side cooled, $T_C=100^{\circ}C$	150			100	A
$I_{F(RMS)}$	RMS forward current		150			157	A
I_{RRM}	Repetitive peak current	at V_{RRM}	150			10	mA
I_{FSM}	Surge forward current	10ms half sine wave	150			2.60	KA
I^2t	I^2T for fusing coordination	$V_R=0.6V_{RRM}$				34	A^2s*10^3
V_{FO}	Threshold voltage		150			0.80	V
r_F	Forward slop resistance					1.74	mΩ
V_{FM}	Peak forward voltage	$I_{FM}=300A$	25			1.45	V
$R_{th(j-c)}$	Thermal resistance Junction to case	At 180° sine: Single side cooled per chip				0.350	$^{\circ}C/W$
$R_{th(c-h)}$	Thermal resistance case to heatsink	At 180° sine: Single side cooled per chip				0.2	$^{\circ}C/W$
V_{iso}	Isolation voltage	50Hz, R.M.S, t=1min, $I_{iso}:1mA(max)$		2500			V
F_m	Terminal connection torque(M5)				4		N·m
	Mounting torque(M6)				6		N·m
T_{stg}	Stored temperature			-40		125	$^{\circ}C$
W_t	Weight				105		g
Outline	M01H						

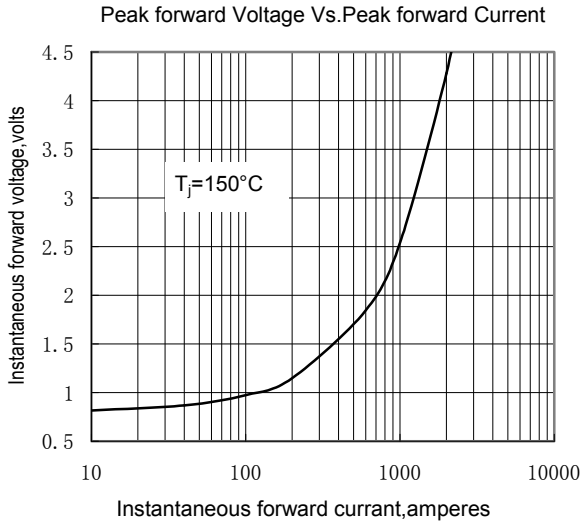
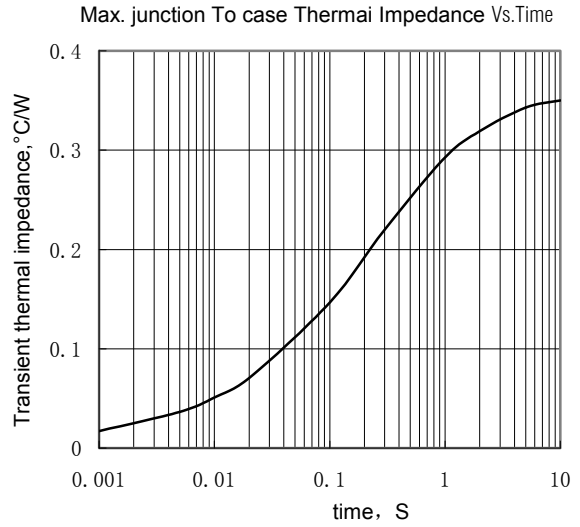
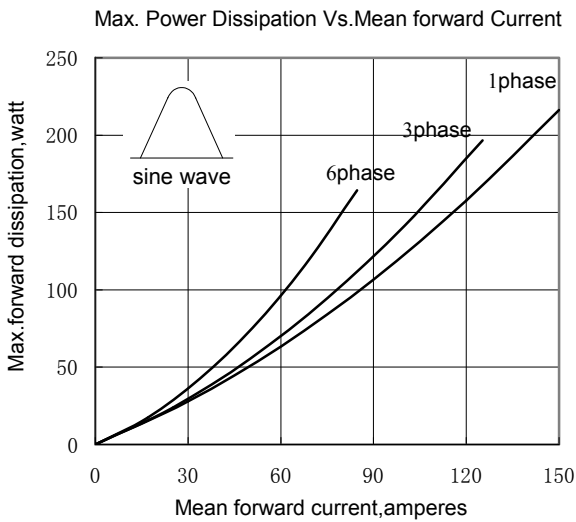
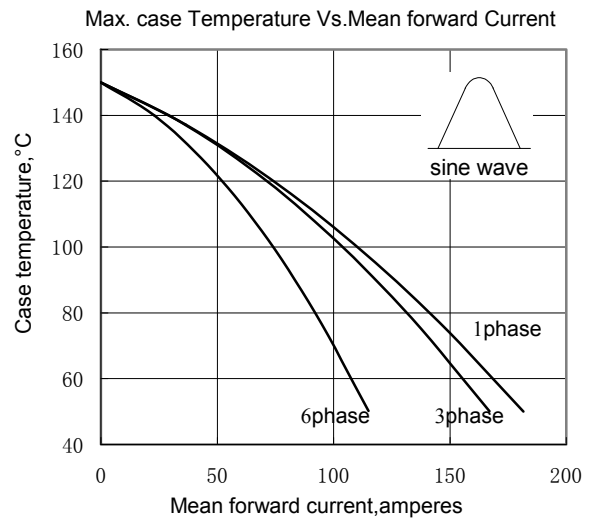
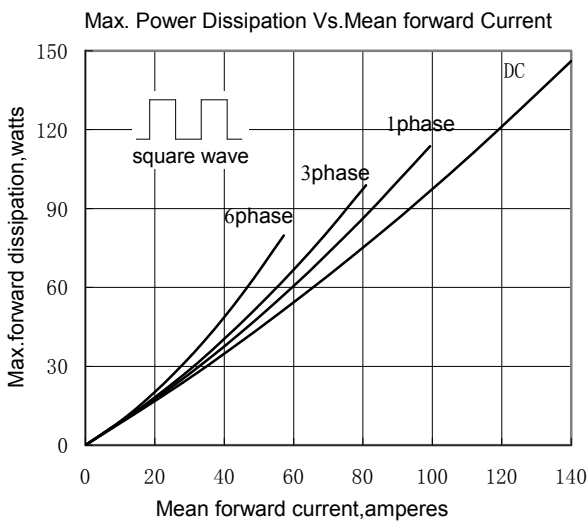
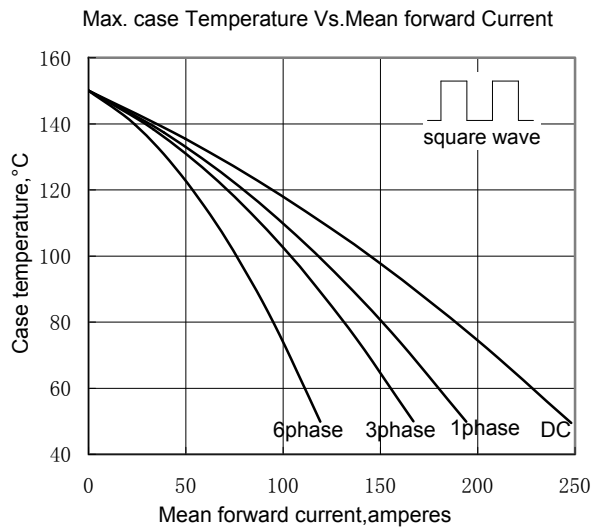
Fig.1

Fig.2

Fig.3

Fig.4

Fig.5

Fig.6

Surge Current Vs.Cycles

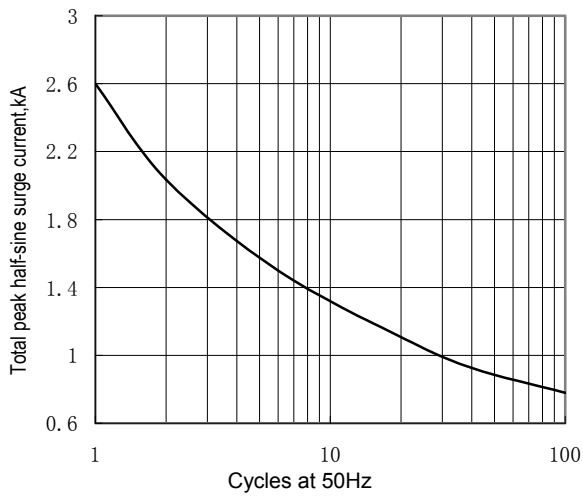

Fig.7

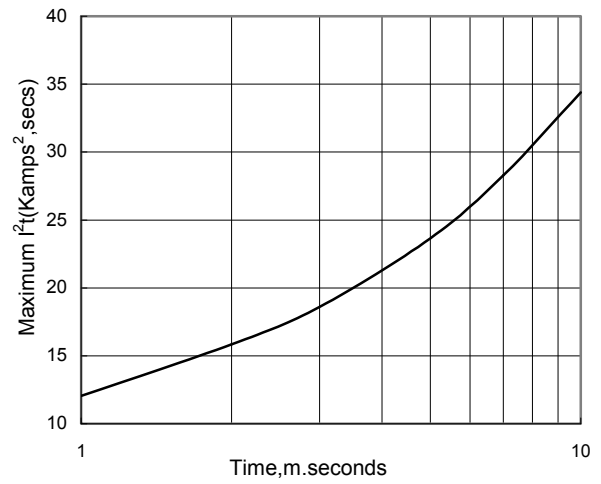
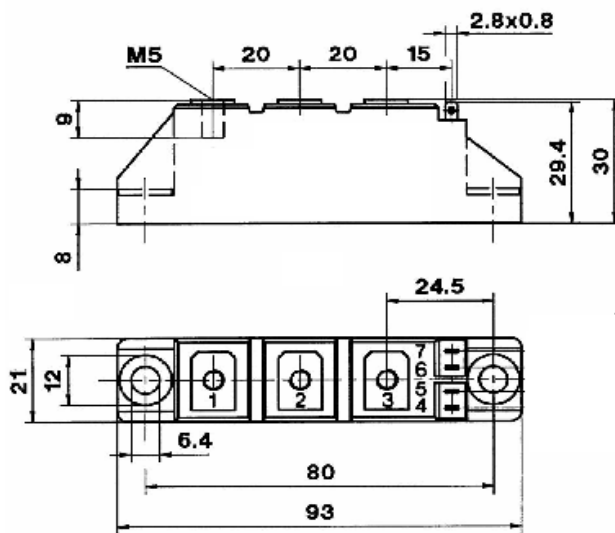
 I^2t Vs.Time

Fig.8

Outline:

M01H
