

General Description

The MDP10N027 uses advanced MagnaChip's MOSFET Technology, which provides high performance in on-state resistance, fast switching performance, and excellent quality.

These devices can also be utilized in industrial applications such as Low Power Drives of E-bike (E-Vehicles), DC/DC converter, and general purpose applications.

Features

- $V_{DS} = 100V$
- $I_D = 120A @ V_{GS} = 10V$
- Very low on-resistance $R_{DS(ON)} < 2.8 m\Omega @ V_{GS} = 10V$
- 100% UIL Tested
- 100% Rg Tested

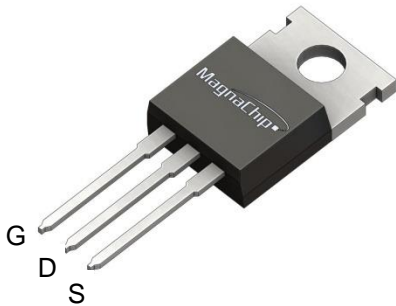

TO-220

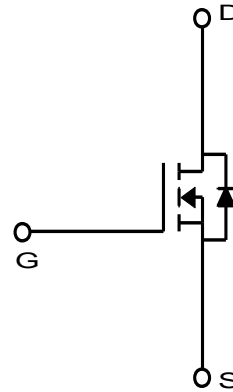

Absolute Maximum Ratings ($T_J = 25^\circ C$)

Characteristics		Symbol	Rating	Unit
Drain-Source Voltage		V_{DSS}	100	V
Gate-Source Voltage		V_{GSS}	± 20	V
Continuous Drain Current ⁽¹⁾	$T_C = 25^\circ C$ (Silicon Limited)	I_D	272	A
	$T_C = 25^\circ C$ (Package Limited)		120	
	$T_C = 100^\circ C$ (Silicon Limited)		192	
Pulsed Drain Current ⁽²⁾		I_{DM}	480	
Power Dissipation	$T_C = 25^\circ C$	P_D	416	W
	$T_C = 100^\circ C$		208	
Single Pulse Avalanche Energy ⁽³⁾		E_{AS}	512	mJ
Junction and Storage Temperature Range		T_J, T_{stg}	-55~175	$^\circ C$

Thermal Characteristics

Characteristics	Symbol	Rating	Unit
Thermal Resistance, Junction-to-Ambient	$R_{\theta JA}$	62.5	$^\circ C/W$
Thermal Resistance, Junction-to-Case	$R_{\theta JC}$	0.36	

Ordering Information

Part Number	Temp. Range	Package	Packing	RoHS Status
MDP10N027TH	-55~175°C	TO-220	Tube	Halogen Free

Electrical Characteristics (T_J = 25°C)

Characteristics	Symbol	Test Condition	Min	Typ	Max	Unit
Static Characteristics						
Drain-Source Breakdown Voltage	BV _{DSS}	I _D = 250μA, V _{GS} = 0V	100	-	-	V
Gate Threshold Voltage	V _{GS(th)}	V _{DS} = V _{GS} , I _D = 250μA	2.0	-	4.0	
Drain Cut-Off Current	I _{DSS}	V _{DS} = 100V, V _{GS} = 0V	-	-	1.0	μA
Gate Leakage Current	I _{GSS}	V _{GS} = ±20V, V _{DS} = 0V	-	-	±0.1	
Drain-Source ON Resistance	R _{DS(on)}	V _{GS} = 10V, I _D = 50A	-	2.5	2.8	mΩ
Forward Transconductance	g _{fs}	V _{DS} = 10V, I _D = 50A	-	110	-	S
Dynamic Characteristics						
Total Gate Charge	Q _g	V _{DS} = 50V, I _D = 50A, V _{GS} = 10V	-	147	-	nC
Gate-Source Charge	Q _{gs}		-	42	-	
Gate-Drain Charge	Q _{gd}		-	28	-	
Input Capacitance	C _{iss}	V _{DS} = 40V, V _{GS} = 0V, f = 1.0MHz	-	10,420	-	pF
Reverse Transfer Capacitance	C _{rss}		-	36	-	
Output Capacitance	C _{oss}		-	2,050	-	
Turn-On Delay Time	t _{d(on)}	V _{GS} = 10V, V _{DS} = 50V, I _D = 50A, R _G = 3.0Ω	-	33	-	ns
Rise Time	t _r		-	20	-	
Turn-Off Delay Time	t _{d(off)}		-	123	-	
Fall Time	t _f		-	45	-	
Gate Resistance	R _g	f=1 MHz	-	3.0	-	Ω
Drain-Source Body Diode Characteristics						
Source-Drain Diode Forward Voltage	V _{SD}	I _S = 50A, V _{GS} = 0V	-	0.9	1.2	V
Body Diode Reverse Recovery Time	t _{rr}	I _F = 50A, di/dt = 100A/μs	-	98	-	ns
Body Diode Reverse Recovery Charge	Q _{rr}		-	275	-	nC

Note :

1. Surface mounted FR-4 board by JEDEC (jesd51-7). Continuous current at T_C=25°C is silicon limited
2. Pulse width limited by T_{Jmax}
3. E_{AS} is tested at starting T_J = 25°C, L = 1.0mH, I_{AS} = 32A, V_{GS} = 10V.

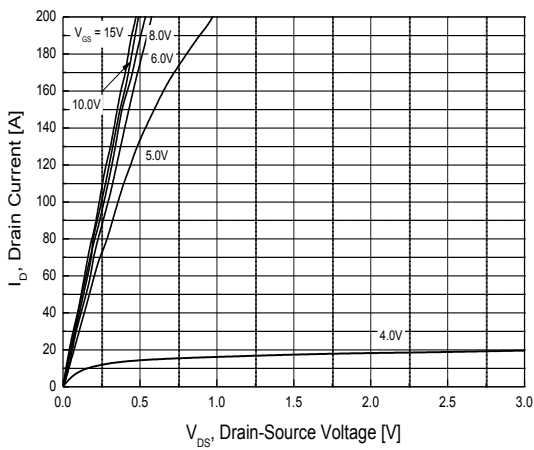

Fig.1 On-Region Characteristics

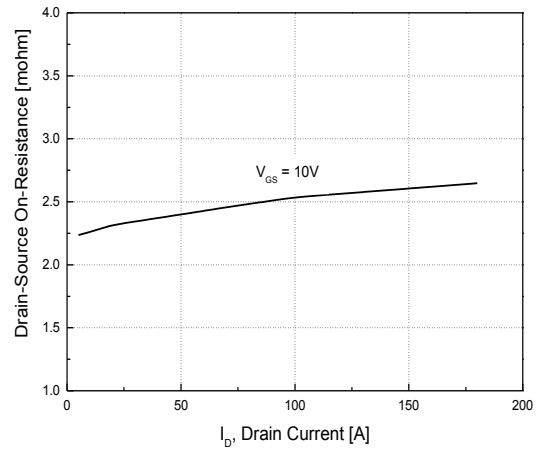

Fig.2 On-Resistance Variation with Drain Current and Gate Voltage

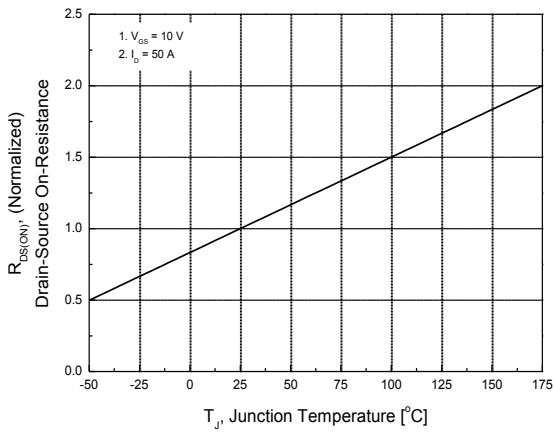

Fig.3 On-Resistance Variation with Temperature

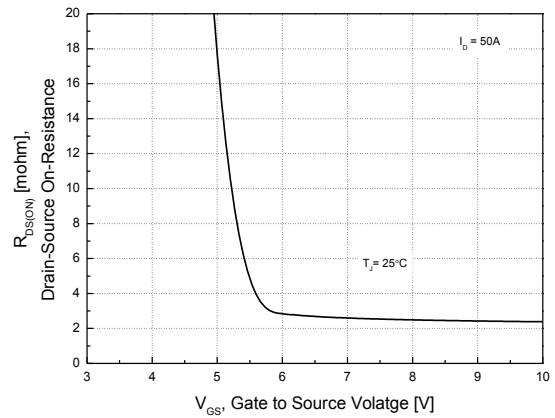

Fig.4 On-Resistance Variation with Gate to Source Voltage

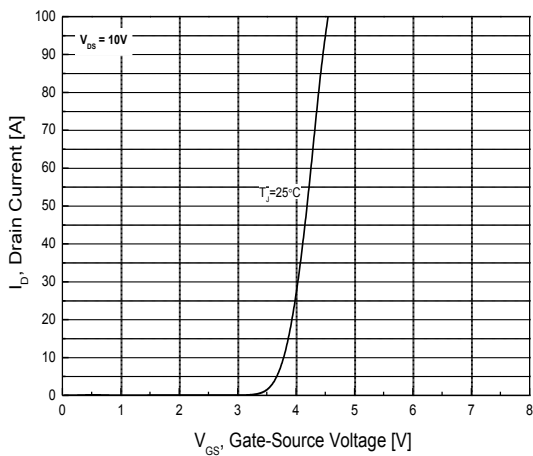

Fig.5 Transfer Characteristics

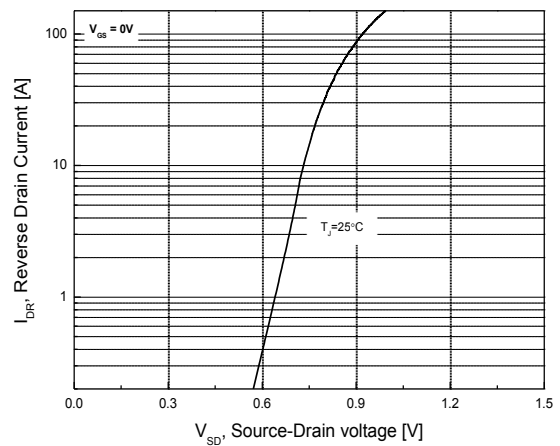

Fig.6 Body Diode Forward Voltage Variation with Source Current and Temperature

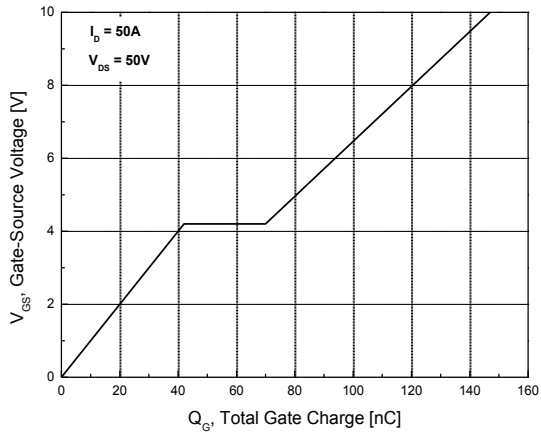

Fig.7 Gate Charge Characteristics

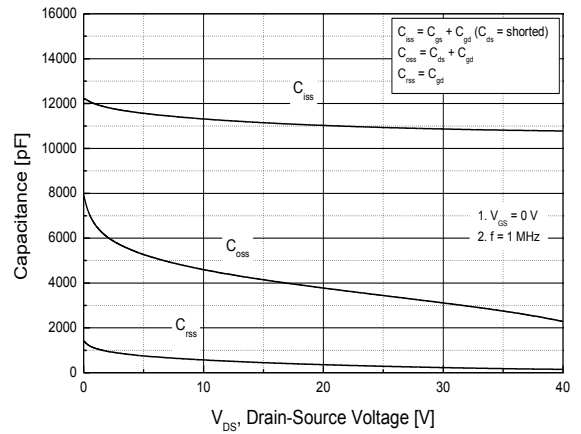

Fig.8 Capacitance Characteristics

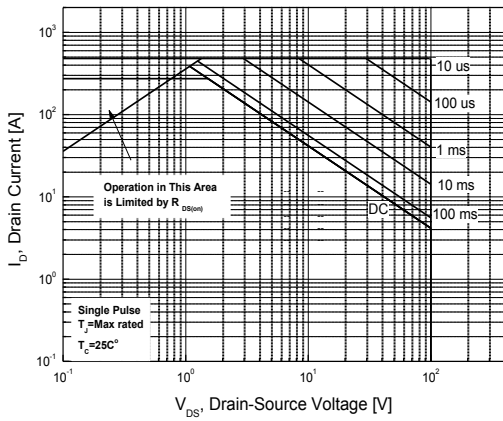

Fig.9 Maximum Safe Operating Area

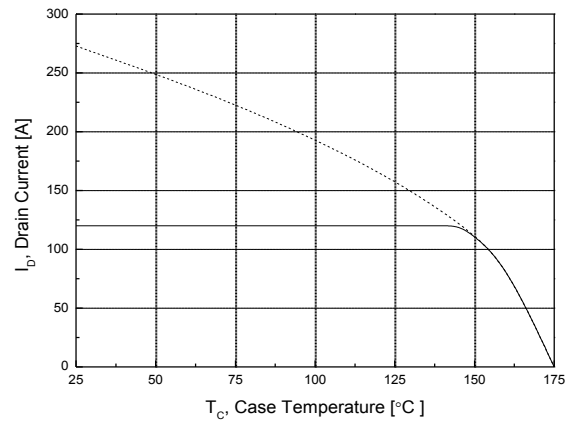

Fig.10 Maximum Drain Current vs. Case Temperature

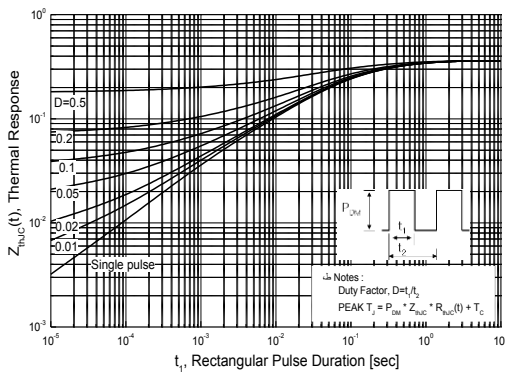
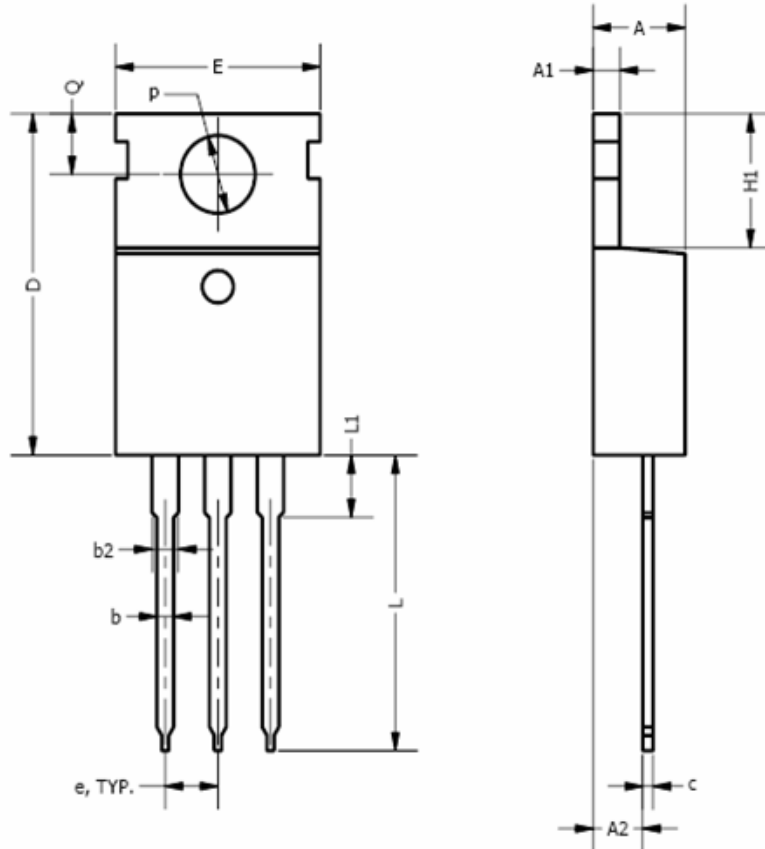

Fig.11 Transient Thermal Response Curve

Package Dimension

3 Leads, TO-220

Dimensions are in millimeters unless otherwise specified



Symbol	Min	Nom	Max
A	3.56		4.83
A1	0.50		1.40
A2	2.03		2.92
b	0.38	0.69	1.02
b2	1.14	1.45	1.78
c	0.36		0.61
D	14.22		16.51
e	2.54 TYP		
E	9.65		10.67
H1	5.84		6.86
L	12.70		14.73
L1			6.35
ϕP	3.53		4.09
Q	2.54		3.43

DISCLAIMER:

The Products are not designed for use in hostile environments, including, without limitation, aircraft, nuclear power generation, medical appliances, and devices or systems in which malfunction of any Product can reasonably be expected to result in a personal injury. Seller's customers using or selling Seller's products for use in such applications do so at their own risk and agree to fully defend and indemnify Seller.

MagnaChip reserves the right to change the specifications and circuitry without notice at any time. MagnaChip does not consider responsibility for use of any circuitry other than circuitry entirely included in a MagnaChip product. [MagnaChip](#) is a registered trademark of MagnaChip Semiconductor Ltd.