

### General Description

The MDQ10N026TH uses advanced Magnachip’s MOSFET Technology, which provides high performance in on-state resistance, fast switching performance, and excellent quality.

These devices can also be utilized in industrial applications such as Low Power Drives of E-Vehicles(E-bike), DC/DC converter, and general purpose applications.

### Features

- $V_{DS} = 100V$
- $I_D = 160A @V_{GS} = 10V$
- Very low on-resistance  $R_{DS(ON)} < 2.6 m\Omega @V_{GS} = 10V$
- 100% UIL Tested
- 100% Rg Tested

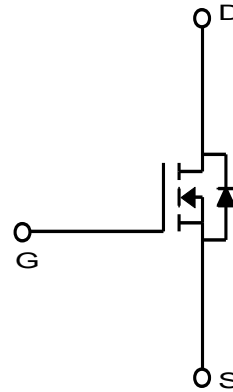
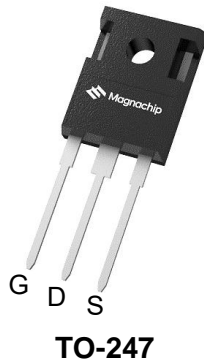

### Absolute Maximum Ratings ( $T_J = 25^\circ C$ )

Characteristics		Symbol	Rating	Unit
Drain-Source Voltage		$V_{DSS}$	100	V
Gate-Source Voltage		$V_{GSS}$	$\pm 20$	V
Continuous Drain Current <sup>(1)</sup>	$T_C=25^\circ C$ (Silicon Limited)	$I_D$	300	A
	$T_C=25^\circ C$ (Package Limited)		160	
	$T_C=100^\circ C$ (Silicon Limited)		212	
Pulsed Drain Current <sup>(2)</sup>		$I_{DM}$	640	
Power Dissipation	$T_C=25^\circ C$	$P_D$	468	W
	$T_C=100^\circ C$		234	
Single Pulse Avalanche Energy <sup>(3)</sup>		$E_{AS}$	544	mJ
Junction and Storage Temperature Range		$T_J, T_{stg}$	-55~175	$^\circ C$

### Thermal Characteristics

Characteristics	Symbol	Rating	Unit
Thermal Resistance, Junction-to-Ambient	$R_{\theta JA}$	40	$^\circ C/W$
Thermal Resistance, Junction-to-Case	$R_{\theta JC}$	0.32	

## Ordering Information

Part Number	Temp. Range	Package	Packing	RoHS Status
MDQ10N026TH	-55~175°C	TO-247	Tube	Halogen Free

## Electrical Characteristics (T<sub>J</sub> =25°C)

Characteristics	Symbol	Test Condition	Min	Typ	Max	Unit
<b>Static Characteristics</b>						
Drain-Source Breakdown Voltage	BV <sub>DSS</sub>	I <sub>D</sub> = 250μA, V <sub>GS</sub> = 0V	100	-	-	V
Gate Threshold Voltage	V <sub>GS(th)</sub>	V <sub>DS</sub> = V <sub>GS</sub> , I <sub>D</sub> = 250μA	2.0	-	4.0	
Drain Cut-Off Current	I <sub>DSS</sub>	V <sub>DS</sub> = 100V, V <sub>GS</sub> = 0V	-	-	1.0	μA
Gate Leakage Current	I <sub>GSS</sub>	V <sub>GS</sub> = ±20V, V <sub>DS</sub> = 0V	-	-	±0.1	
Drain-Source ON Resistance	R <sub>DS(on)</sub>	V <sub>GS</sub> = 10V, I <sub>D</sub> = 100A	-	2.3	2.6	mΩ
Forward Transconductance	g <sub>fs</sub>	V <sub>DS</sub> = 10V, I <sub>D</sub> = 100A	-	130	-	S
<b>Dynamic Characteristics</b>						
Total Gate Charge	Q <sub>g</sub>	V <sub>DS</sub> = 50V, I <sub>D</sub> = 50A, V <sub>GS</sub> = 10V	-	147	-	nC
Gate-Source Charge	Q <sub>gs</sub>		-	42	-	
Gate-Drain Charge	Q <sub>gd</sub>		-	28	-	
Input Capacitance	C <sub>iss</sub>	V <sub>DS</sub> = 40V, V <sub>GS</sub> = 0V, f = 1.0MHz	-	10,420	-	pF
Reverse Transfer Capacitance	C <sub>rss</sub>		-	75	-	
Output Capacitance	C <sub>oss</sub>		-	2,050	-	
Turn-On Delay Time	t <sub>d(on)</sub>	V <sub>GS</sub> = 10V, V <sub>DS</sub> = 50V, I <sub>D</sub> = 100A, R <sub>G</sub> = 3.0Ω	-	32	-	ns
Rise Time	t <sub>r</sub>		-	27	-	
Turn-Off Delay Time	t <sub>d(off)</sub>		-	98	-	
Fall Time	t <sub>f</sub>		-	26	-	
Gate Resistance	R <sub>g</sub>	f=1 MHz	-	3.0	-	Ω
<b>Drain-Source Body Diode Characteristics</b>						
Source-Drain Diode Forward Voltage	V <sub>SD</sub>	I <sub>S</sub> = 100A, V <sub>GS</sub> = 0V	-	0.9	1.2	V
Body Diode Reverse Recovery Time	t <sub>rr</sub>	I <sub>F</sub> = 100A, dI/dt = 100A/μs	-	127	-	ns
Body Diode Reverse Recovery Charge	Q <sub>rr</sub>		-	416	-	nC

Note :

1. Surface mounted FR-4 board by JEDEC (jesd51-7). Continuous current at T<sub>c</sub>=25°C is silicon limited
2. Pulse width limited by T<sub>Jmax</sub>
3. E<sub>AS</sub> is tested at starting T<sub>j</sub> = 25°C, L = 1.0mH, I<sub>AS</sub> = 33A, V<sub>GS</sub> = 10V.

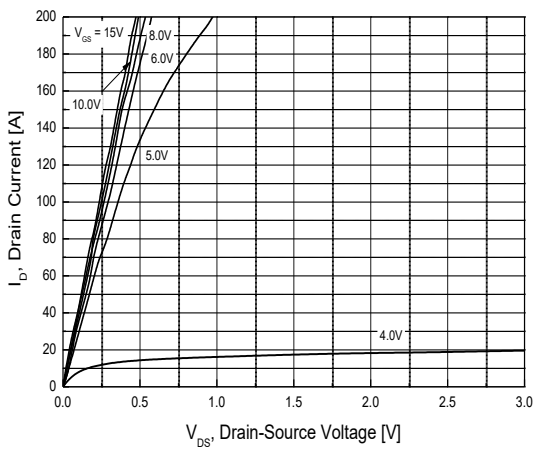

**Fig.1 On-Region Characteristics**

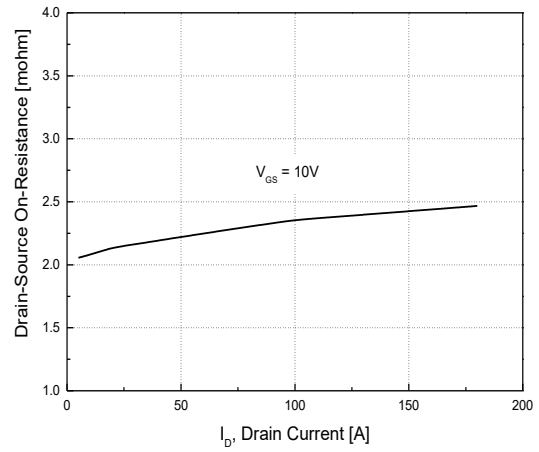

**Fig.2 On-Resistance Variation with Drain Current and Gate Voltage**

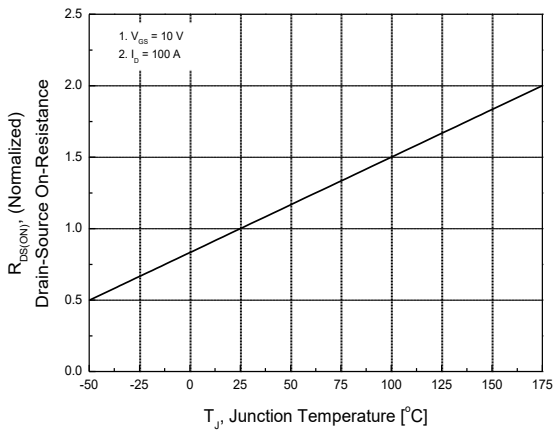

**Fig.3 On-Resistance Variation with Temperature**

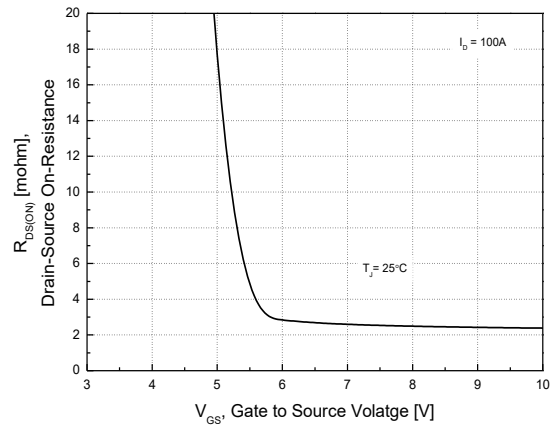

**Fig.4 On-Resistance Variation with Gate to Source Voltage**

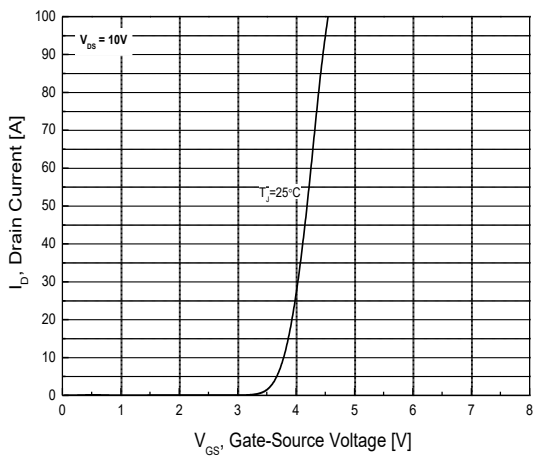

**Fig.5 Transfer Characteristics**

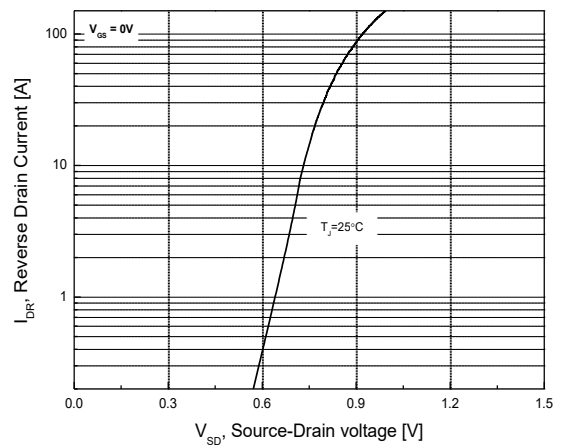

**Fig.6 Body Diode Forward Voltage Variation with Source Current and Temperature**

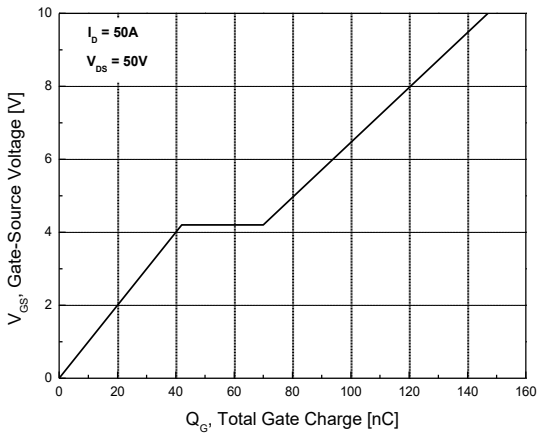

**Fig.7 Gate Charge Characteristics**

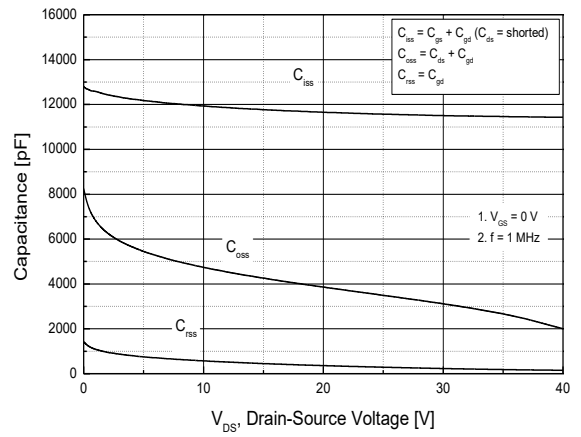

**Fig.8 Capacitance Characteristics**

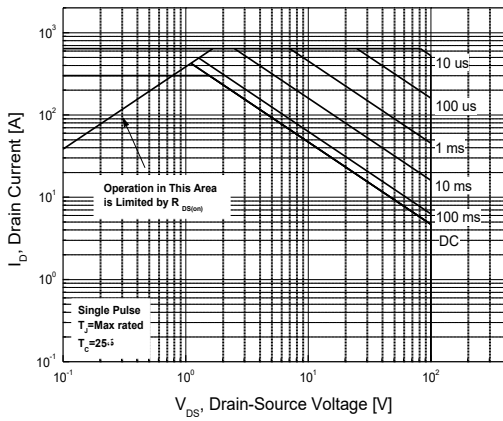

**Fig.9 Maximum Safe Operating Area**

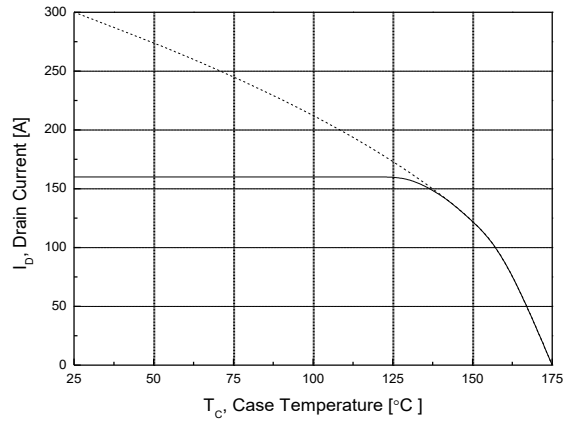

**Fig.10 Maximum Drain Current vs. Case Temperature**

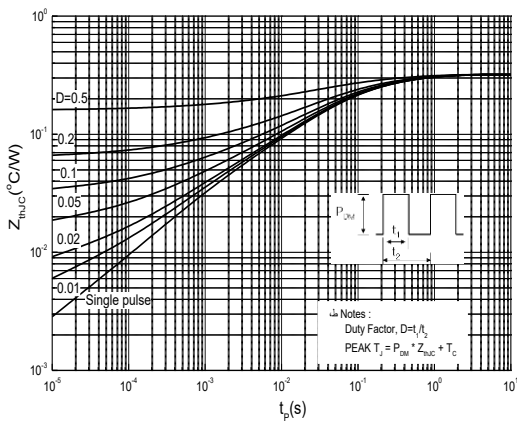
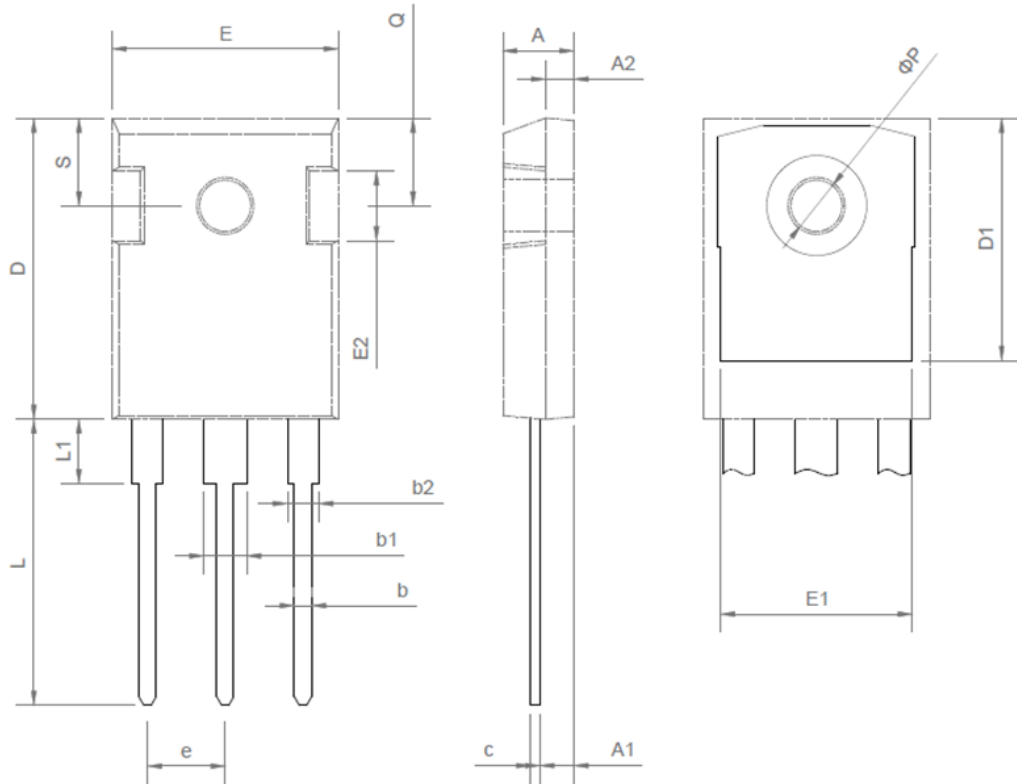

**Fig.11 Transient Thermal Response Curve**

## Package Dimension

### TO-247

Dimensions are in millimeters unless otherwise specified



Symbol	Dimension [mm]		
	Min	Nom	Max
A	4.70	-	5.31
A1	2.20	-	2.60
A2	1.50	-	2.49
b	0.99	-	1.40
b1	2.59	-	3.43
b2	1.65	-	2.39
c	0.38	-	0.89
D	20.30	-	21.46
D1	13.08	-	-
E	15.45	-	16.26
E1	13.06	-	14.15
E2	4.32	-	5.49
e	5.45 BSC		
L	19.81	-	20.57
L1	-	-	4.50
ΦP	3.50	-	3.70
Q	5.38	-	6.20
S	6.15 BSC		

Note : Package body size, length and width do not include mold flash, protrusions and gate burrs.

**DISCLAIMER:**

The Products are not designed for use in hostile environments, including, without limitation, aircraft, nuclear power generation, medical appliances, and devices or systems in which malfunction of any Product can reasonably be expected to result in a personal injury. Seller's customers using or selling Seller's products for use in such applications do so at their own risk and agree to fully defend and indemnify Seller.

Magnachip reserves the right to change the specifications and circuitry without notice at any time. Magnachip does not consider responsibility for use of any circuitry other than circuitry entirely included in a Magnachip product.  Magnachip is a registered trademark of Magnachip Semiconductor Ltd.