

### General Description

The MDS5652 uses advanced MagnaChip's MOSFET Technology, which provides low on-state resistance, high switching performance and excellent reliability.

### Features

- $V_{DS} = 30V$
- $I_D = 7.5A$  @  $V_{GS} = 10V$
- $R_{DS(ON)} < 22m\Omega$  @  $V_{GS} = 10V$   
 $< 35m\Omega$  @  $V_{GS} = 4.5V$

### Applications

- Portable Equipment Applications
- DC-DC Converter applications
- General purpose applications

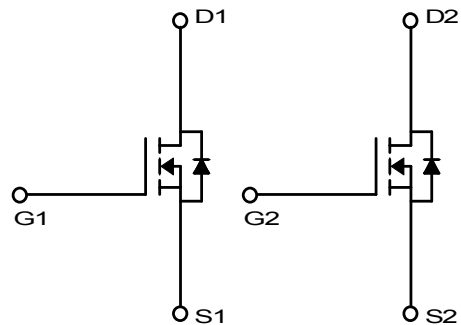
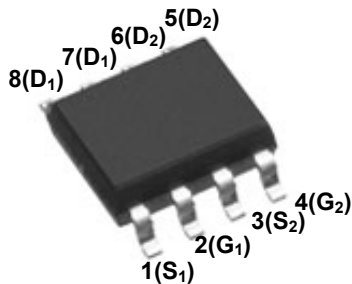

### Absolute Maximum Ratings ( $T_a = 25^\circ C$ unless otherwise noted)

Characteristics	Symbol	Rating	Unit
Drain-Source Voltage	$V_{DSS}$	30	V
Gate-Source Voltage	$V_{GSS}$	$\pm 20$	V
Continuous Drain Current	$I_D$	$T_a = 25^\circ C$	7.5
		$T_a = 100^\circ C$	4.8
Pulsed Drain Current	$I_{DM}$	30	A
Power Dissipation <sup>(1)</sup>	$P_D$	$T_a = 25^\circ C$	2.0
		$T_a = 100^\circ C$	0.8
Single Pulse Avalanche Energy <sup>(2)</sup>	$E_{AS}$	12	mJ
Junction and Storage Temperature Range	$T_J, T_{stg}$	-55~+150	$^\circ C$

### Thermal Characteristics

Characteristics	Symbol	Rating	Unit
Thermal Resistance, Junction-to-Ambient(Steady-State) <sup>(1)</sup>	$R_{\theta JA}$	62.5	$^\circ C/W$
Thermal Resistance, Junction-to-Case	$R_{\theta JC}$	50	

## Ordering Information

Part Number	Temp. Range	Package	Packing	RoHS Status
MDS5652URH	-55~150°C	SOIC-8	Tape & Reel	Halogen Free

## Electrical Characteristics (T<sub>J</sub> = 25°C unless otherwise noted)

Characteristics	Symbol	Test Condition	Min	Typ	Max	Unit
<b>Static Characteristics</b>						
Drain-Source Breakdown Voltage	BV <sub>DSS</sub>	I <sub>D</sub> = 250μA, V <sub>GS</sub> = 0V	30	-	-	V
Zero Gate Voltage Drain Current	I <sub>DSS</sub>	V <sub>DS</sub> = 24V, V <sub>GS</sub> = 0V			1	μA
Gate to Source Leakage Current	I <sub>GSS</sub>	V <sub>GS</sub> = ±20V, V <sub>DS</sub> = 0V	-	-	100	nA
Gate to Source Threshold Voltage	V <sub>GS(th)</sub>	V <sub>DS</sub> = V <sub>GS</sub> , I <sub>D</sub> = 250μA	1	1.9	3	V
Static Drain to Source On Resistance	R <sub>DS(ON)</sub>	V <sub>GS</sub> = 10V, I <sub>D</sub> = 7.5A	-	16	22	mΩ
		V <sub>GS</sub> = 4.5V, I <sub>D</sub> = 5.0A		23	35	
Forward Transconductance	g <sub>FS</sub>	V <sub>DS</sub> = 5V, I <sub>D</sub> = 7.5A		25	-	S
<b>Dynamic Characteristics</b>						
Total Gate Charge	Q <sub>g(10V)</sub>	V <sub>DD</sub> = 30V, I <sub>D</sub> = 7.5A, V <sub>GS</sub> = 10V	-	11.7	-	nC
Total Gate Charge	Q <sub>g(4.5V)</sub>			6.1		
Gate to Source Charge	Q <sub>gs</sub>			2.1	-	
Gate to Drain Charge	Q <sub>gd</sub>			3.2	-	
Input Capacitance	C <sub>iss</sub>	V <sub>DS</sub> = 30V, V <sub>GS</sub> = 0V, f = 1.0MHz	-	460	-	pF
Reverse Transfer Capacitance	C <sub>rss</sub>			58	-	
Output Capacitance	C <sub>oss</sub>			154	-	
Turn-On Delay Time	t <sub>d(on)</sub>	V <sub>GS</sub> = 10V, V <sub>DD</sub> = 15V, R <sub>L</sub> = 2.1Ω, R <sub>GEN</sub> = 3Ω	-	3.8	-	ns
Turn-On Rise Time	t <sub>r</sub>			24.6	-	
Turn-Off Delay Time	t <sub>d(off)</sub>			17.4	-	
Turn-Off Fall Time	t <sub>f</sub>			10.6	-	
<b>Drain-Source Body Diode Characteristics</b>						
Source-Drain Diode Forward Voltage	V <sub>SD</sub>	I <sub>S</sub> = 1A, V <sub>GS</sub> = 0V	-	0.75		V
Body Diode Reverse Recovery Time	t <sub>rr</sub>	I <sub>F</sub> = 7.5A, di/dt = 100A/μs	-	16	-	ns
Body Diode Reverse Recovery Charge	Q <sub>rr</sub>			-	7.5	-

Note :

- Surface mounted FR-4 board with 2oz. Copper.
- Starting T<sub>J</sub> = 25°C, L = 1mH, I<sub>AS</sub> = 5A, V<sub>DD</sub> = 15V, V<sub>GS</sub> = 10V

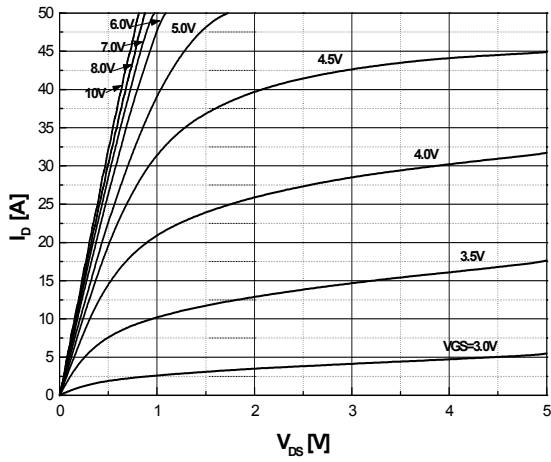

**Fig.1 On-Region Characteristics**

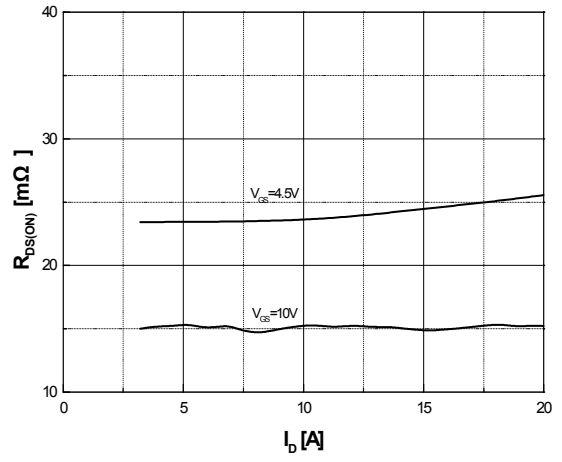

**Fig.2 On-Resistance Variation with Drain Current and Gate Voltage**

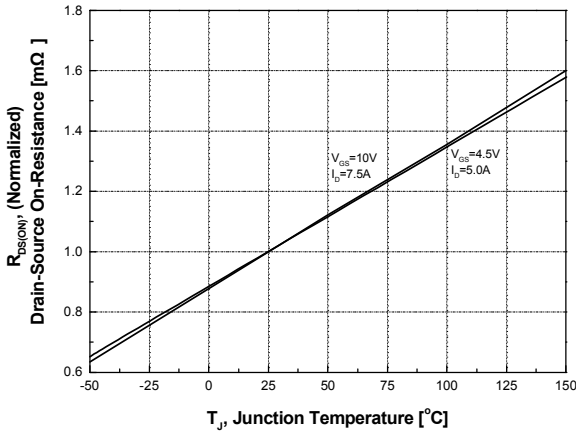

**Fig.3 On-Resistance Variation with Temperature**

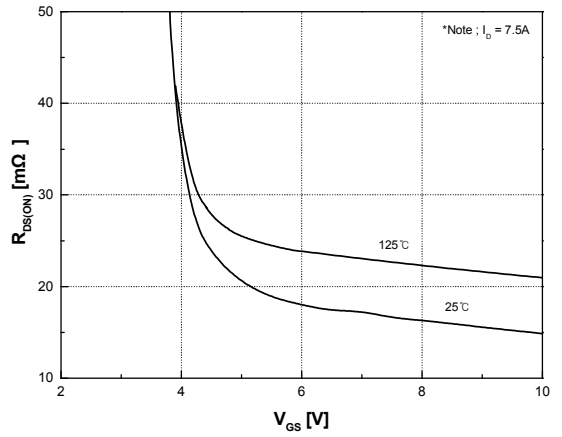

**Fig.4 On-Resistance Variation with Gate to Source Voltage**

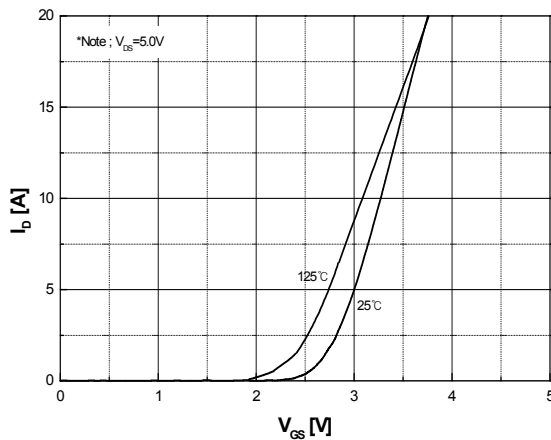

**Fig.5 Transfer Characteristics**

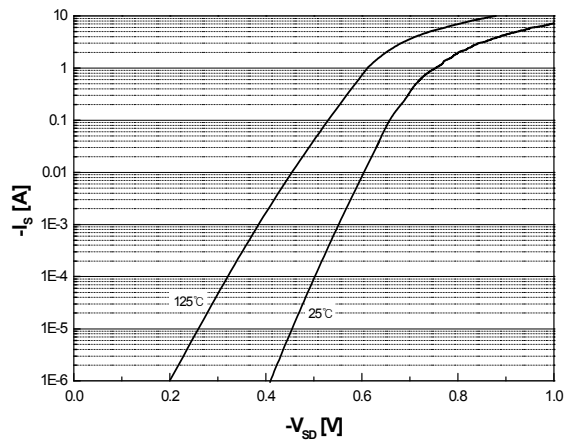

**Fig.6 Body Diode Forward Voltage Variation with Source Current and Temperature**

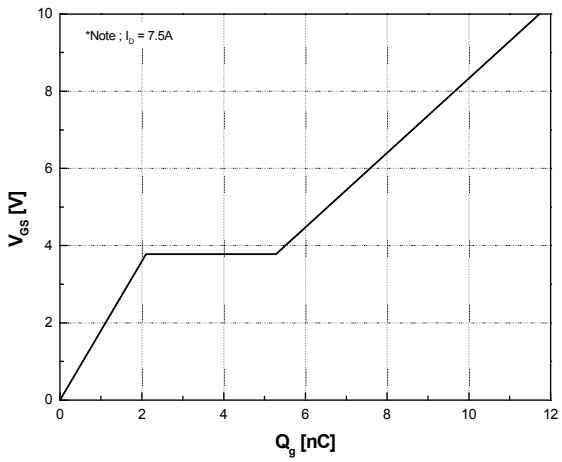

**Fig.7 Gate Charge Characteristics**

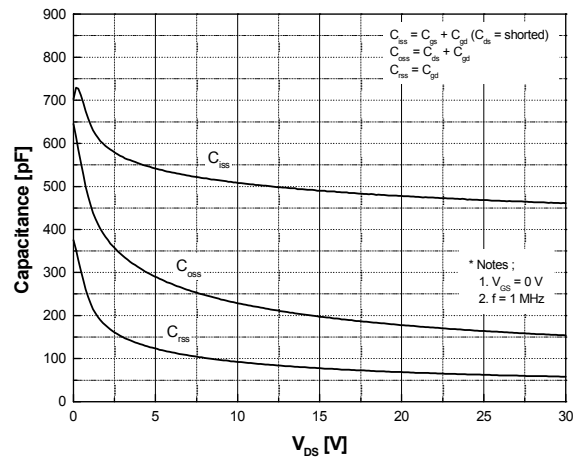

**Fig.8 Capacitance Characteristics**

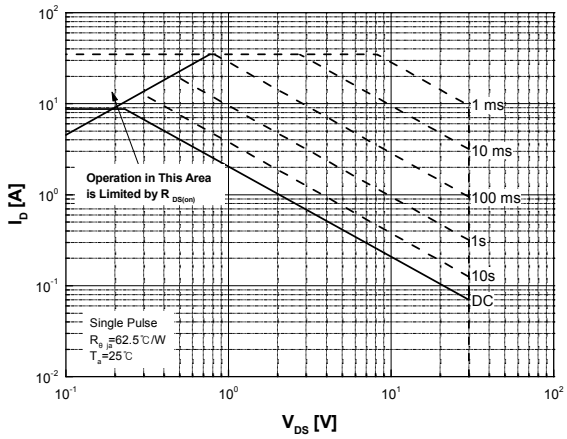

**Fig.9 Maximum Safe Operating Area**

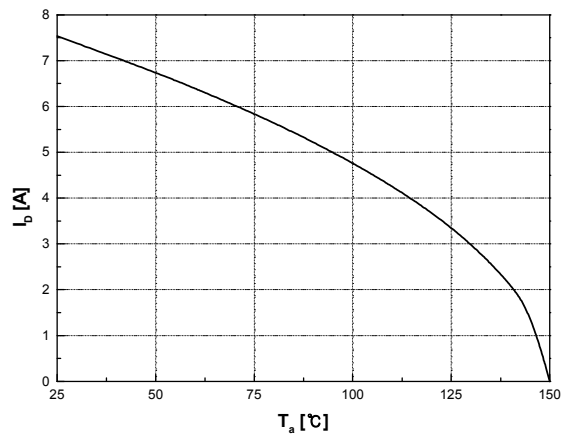

**Fig.10 Maximum Drain Current Vs. Ambient Temperature**

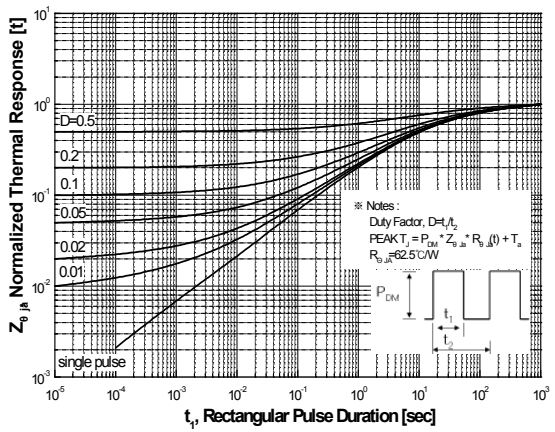
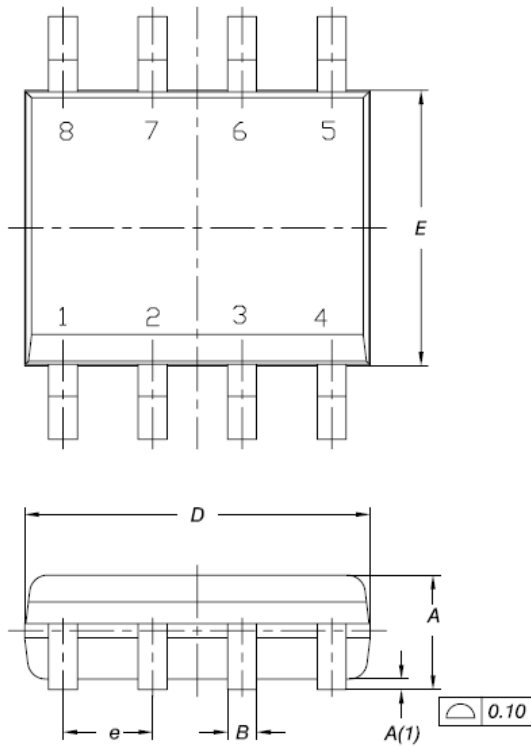

**Fig.11 Transient Thermal Response Curve**

## Physical Dimensions

### 8 Leads, SOIC

Dimensions are in millimeters unless otherwise specified



DIM.	MILLIMETERS		
	MIN.	NOM.	MAX.
A	1.35	1.55	1.75
A(1)	0.10	0.175	0.25
B	0.38	0.445	0.51
C	0.19	0.22	0.25
D	4.80	4.90	5.00
E	3.80	3.90	4.00
e	1.27 BSC		
H	5.80	6.00	6.20
L	0.50	0.715	0.93
$\alpha$	0°	4°	8°
h	0.25	0.375	0.50

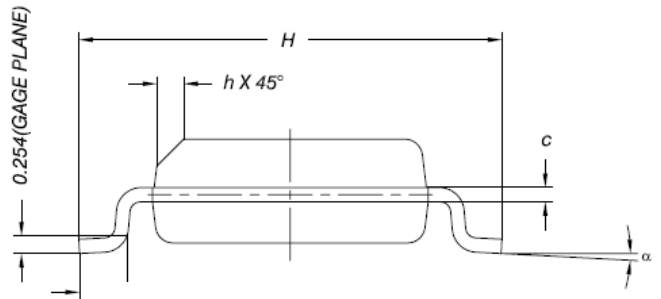

## Worldwide Sales Support Locations

### U.S.A

#### Sunnyvale Office

787 N. Mary Ave. Sunnyvale  
CA 94085 U.S.A  
Tel : 1-408-636-5200  
Fax : 1-408-213-2450  
E-Mail : americasales@magnachip.com

#### Chicago Office

2300 Barrington Road, Suite 330  
Hoffman Estates, IL 60195 U.S.A  
Tel : 1-847-882-0951  
Fax : 1-847-882-0998

### U.K

Knyvett House The Causeway,  
Staines Middx, TW18 3BA, U.K.  
Tel : +44 (0) 1784-898-8000  
Fax : +44 (0) 1784-895-115  
E-Mail : europesales@magnachip.com

### Japan

#### Tokyo Office

Shinbashi 2-chome MT bldg  
4F 2-5-5 Shinbashi, Minato-ku  
Tokyo, 105-0004 Japan  
Tel : 81-3-3595-0632  
Fax : 81-3-3595-0671  
E-Mail : japansales@magnachip.com

#### Osaka Office

3F, Shin-Osaka MT-2 Bldg  
3-5-36 Miyahara Yodogawa-Ku  
Osaka, 532-0003 Japan  
Tel : 81-6-6394-8224  
Fax : 81-6-6394-8282  
E-Mail : osakasales@magnachip.com

### Taiwan R.O.C

2F, No.61, Chowize Street, Nei Hu  
Taipei, 114 Taiwan R.O.C  
Tel : 886-2-2657-7898  
Fax : 886-2-2657-8751  
E-Mail : taiwansales@magnachip.com

### China

#### Hong Kong Office

Office 03, 42/F, Office Tower Convention Plaza  
1 Harbour Road, Wanchai, Hong Kong  
Tel : 852-2828-9700  
Fax : 852-2802-8183  
E-Mail : chinasales@magnachip.com

#### Shenzhen Office

Room 1803, 18/F  
International Chamber of Commerce Tower  
Fuhua 3Road, Futian District  
ShenZhen, China  
Tel : 86-755-8831-5561  
Fax : 86-755-8831-5565

#### Shanghai Office

Ste 1902, 1 Huaihai Rd. (C) 20021  
Shanghai, China  
Tel : 86-21-6373-5181  
Fax : 86-21-6373-6640

### Korea

891, Daechi-Dong, Kangnam-Gu  
Seoul, 135-738 Korea  
Tel : 82-2-6903-3451  
Fax : 82-2-6903-3668 ~9  
Email : koreasales@magnachip.com

### DISCLAIMER:

The Products are not designed for use in hostile environments, including, without limitation, aircraft, nuclear power generation, medical appliances, and devices or systems in which malfunction of any Product can reasonably be expected to result in a personal injury. Seller's customers using or selling Seller's products for use in such applications do so at their own risk and agree to fully defend and indemnify Seller.

MagnaChip reserves the right to change the specifications and circuitry without notice at any time. MagnaChip does not consider responsibility for use of any circuitry other than circuitry entirely included in a MagnaChip product. **MagnaChip** is a registered trademark of MagnaChip Semiconductor Ltd.