

General Description

The MDU1515 uses advanced Magnachip’s MOSFET Technology, which provides high performance in on-state resistance, fast switching performance and excellent quality. MDU1515 is suitable device for DC/DC Converter and general purpose applications.

Features

- $V_{DS} = 30V$
- $I_D = 57.4A @ V_{GS} = 10V$
- $R_{DS(ON)} < 7.2 m\Omega @ V_{GS} = 10V$
 $< 11.0 m\Omega @ V_{GS} = 4.5V$
- 100% UIL Tested
- 100% Rg Tested

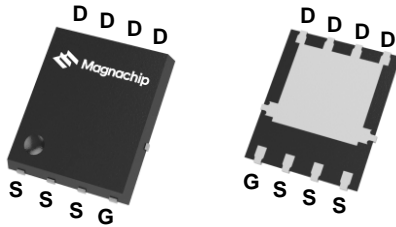

PowerDFN56

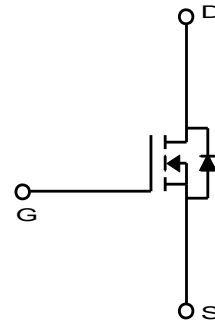

Absolute Maximum Ratings (Ta = 25°C)

Characteristics		Symbol	Rating	Unit
Drain-Source Voltage		V_{DSS}	30	V
Gate-Source Voltage		V_{GSS}	±20	V
Continuous Drain Current ⁽¹⁾	$T_C=25^\circ C$	I_D	57.4	A
	$T_C=70^\circ C$		45.9	
	$T_A=25^\circ C$		20.8 ⁽³⁾	
	$T_A=70^\circ C$		16.6 ⁽³⁾	
Pulsed Drain Current		I_{DM}	230	A
Power Dissipation	$T_C=25^\circ C$	P_D	41.6	W
	$T_C=70^\circ C$		26.6	
	$T_A=25^\circ C$		5.5 ⁽³⁾	
	$T_A=70^\circ C$		3.5 ⁽³⁾	
Single Pulse Avalanche Energy ⁽²⁾		E_{AS}	65.0	mJ
Junction and Storage Temperature Range		T_J, T_{stg}	-55~150	°C

Thermal Characteristics

Characteristics	Symbol	Rating	Unit
Thermal Resistance, Junction-to-Ambient ⁽¹⁾	$R_{\theta JA}$	22.7	°C/W
Thermal Resistance, Junction-to-Case	$R_{\theta JC}$	3.0	

Ordering Information

Part Number	Temp. Range	Package	Packing	Quantity	RoHS Status
MDU1515URH	-55~150°C	PowerDFN56	Tape & Reel	3000 units	Halogen Free

Electrical Characteristics (T_J =25°C)

Characteristics	Symbol	Test Condition	Min	Typ	Max	Unit
Static Characteristics						
Drain-Source Breakdown Voltage	BV _{DSS}	I _D = 250μA, V _{GS} = 0V	30	-	-	V
Gate Threshold Voltage	V _{GS(th)}	V _{DS} = V _{GS} , I _D = 250μA	1.3	1.9	2.7	
Drain Cut-Off Current	I _{DSS}	V _{DS} = 30V, V _{GS} = 0V	-	-	1	μA
Gate Leakage Current	I _{GSS}	V _{GS} = ±20V, V _{DS} = 0V	-	-	±0.1	
Drain-Source ON Resistance	R _{DS(ON)}	V _{GS} = 10V, I _D = 16A	-	6.3	7.2	mΩ
		T _J =125°C	-	9.1	10.5	
Forward Transconductance	g _{fs}	V _{DS} = 5V, I _D = 10A	-	35	-	S
Dynamic Characteristics						
Total Gate Charge	Q _{g(10V)}	V _{DS} = 15.0V, I _D = 16A, V _{GS} = 10V	13.1	17.5	21.9	nC
Total Gate Charge	Q _{g(4.5V)}		6.3	8.4	10.5	
Gate-Source Charge	Q _{gs}		-	3.6	-	
Gate-Drain Charge	Q _{gd}		-	2.8	-	
Input Capacitance	C _{iss}	V _{DS} = 15.0V, V _{GS} = 0V, f = 1.0MHz	816	1088	1360	pF
Reverse Transfer Capacitance	C _{rss}		79	105	131	
Output Capacitance	C _{oss}		164	218	273	
Turn-On Delay Time	t _{d(on)}	V _{GS} = 10V, V _{DS} = 15.0V, I _D = 16A, R _G = 3.0Ω	-	3.0	-	ns
Rise Time	t _r		-	8.6	-	
Turn-Off Delay Time	t _{d(off)}		-	24.3	-	
Fall Time	t _f		-	8.2	-	
Gate Resistance	R _g	f=1 MHz	1.0	3.0	4.5	Ω
Drain-Source Body Diode Characteristics						
Source-Drain Diode Forward Voltage	V _{SD}	I _S = 16A, V _{GS} = 0V	-	0.8	1.1	V
Body Diode Reverse Recovery Time	t _{rr}	I _F = 16A, di/dt = 100A/μs	-	24.9	37.4	ns
Body Diode Reverse Recovery Charge	Q _{rr}		-	16.5	24.8	nC

Note :

- Surface mounted FR-4 board by JEDEC (jesd51-7)
- E_{AS} is tested at starting T_j = 25°C, L = 0.1mH, I_{AS} = 18A, V_{DD} = 27V, V_{GS} = 10V
- T < 10sec.

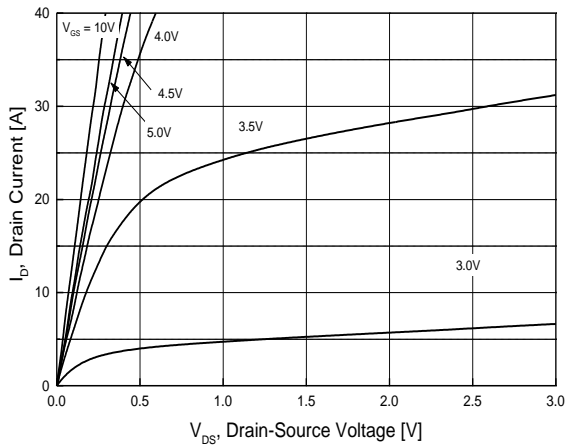

Fig.1 On-Region Characteristics

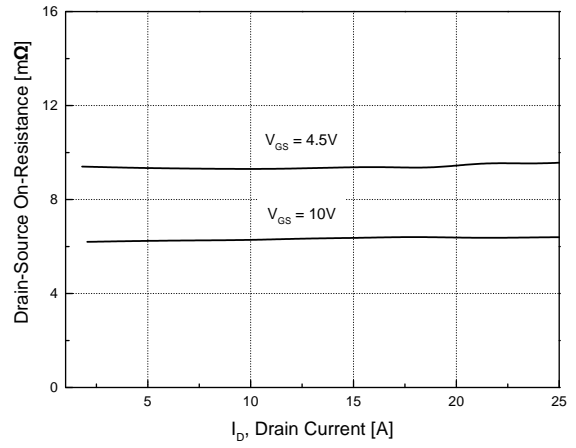

Fig.2 On-Resistance Variation with Drain Current and Gate Voltage

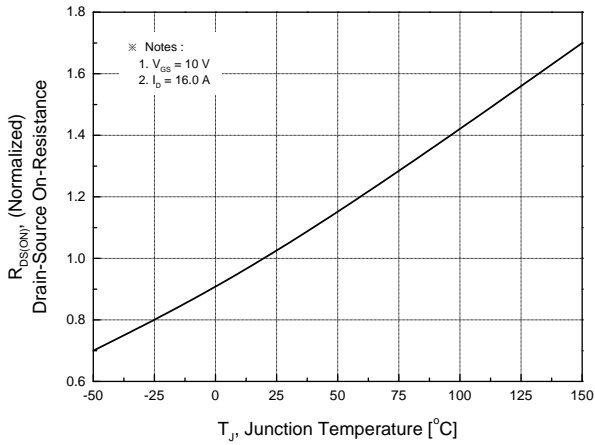

Fig.3 On-Resistance Variation with Temperature

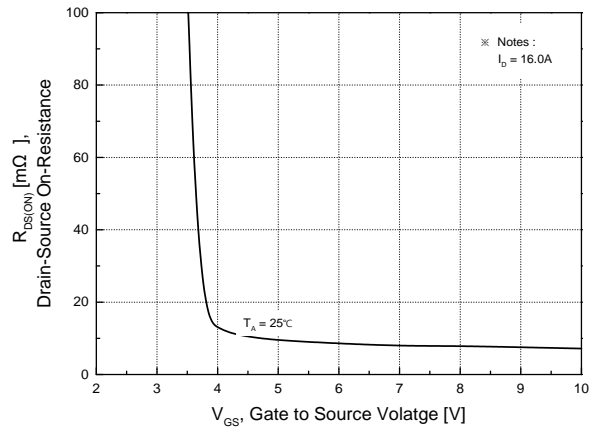

Fig.4 On-Resistance Variation with Gate to Source Voltage

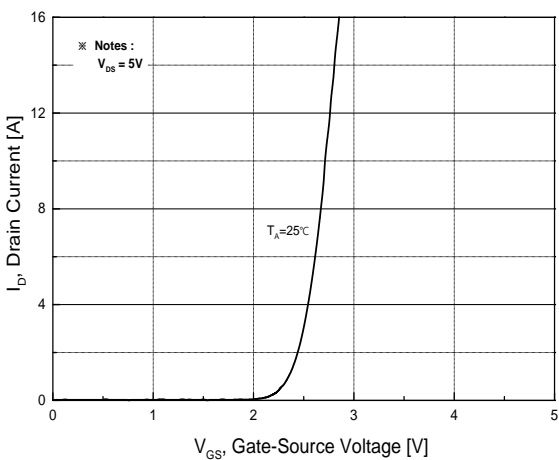

Fig.5 Transfer Characteristics

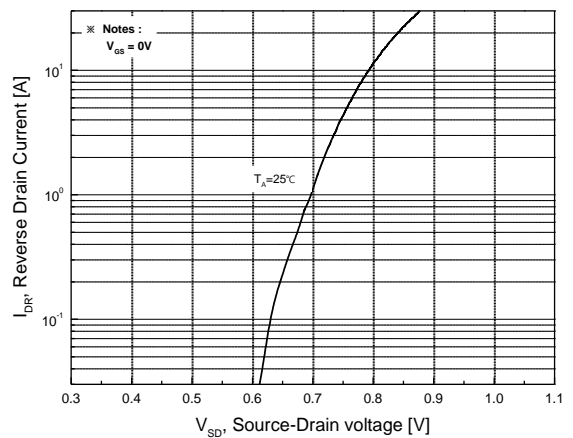

Fig.6 Body Diode Forward Voltage Variation with Source Current and Temperature

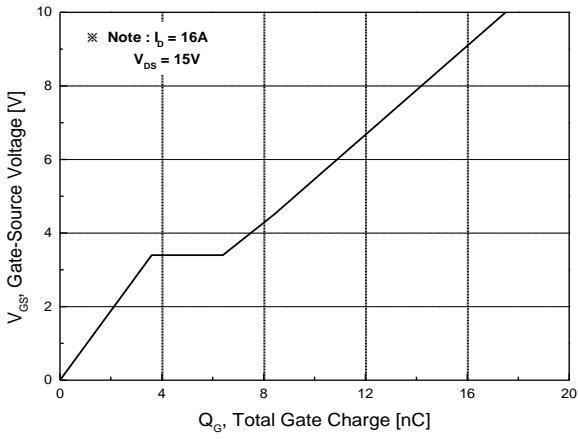

Fig.7 Gate Charge Characteristics

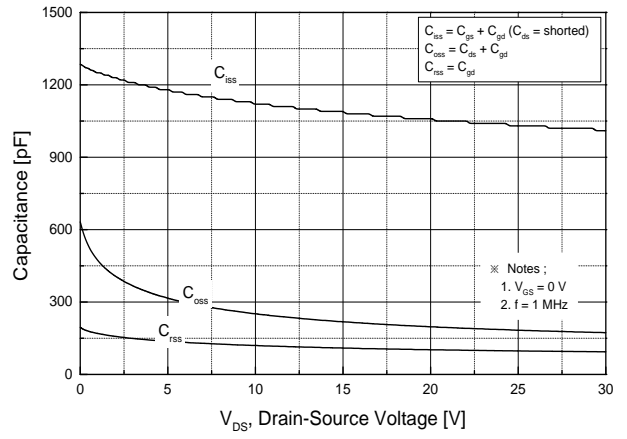

Fig.8 Capacitance Characteristics

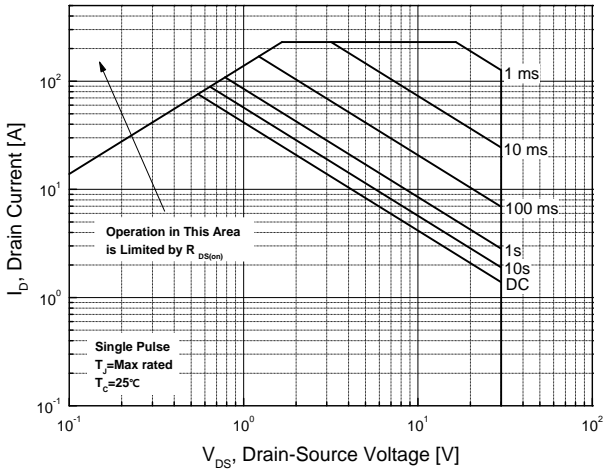

Fig.9 Maximum Safe Operating Area

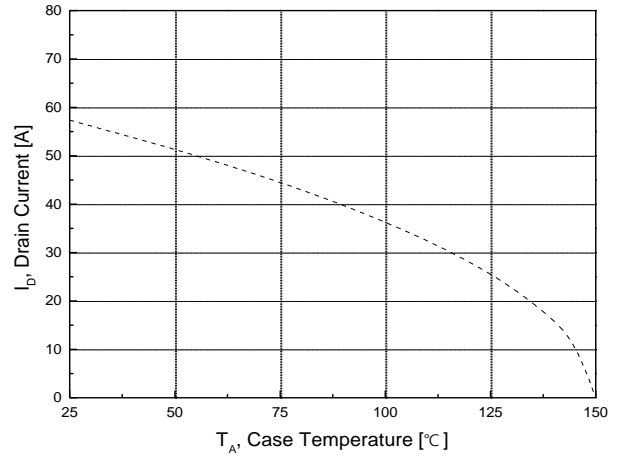

Fig.10 Maximum Drain Current vs. Case Temperature

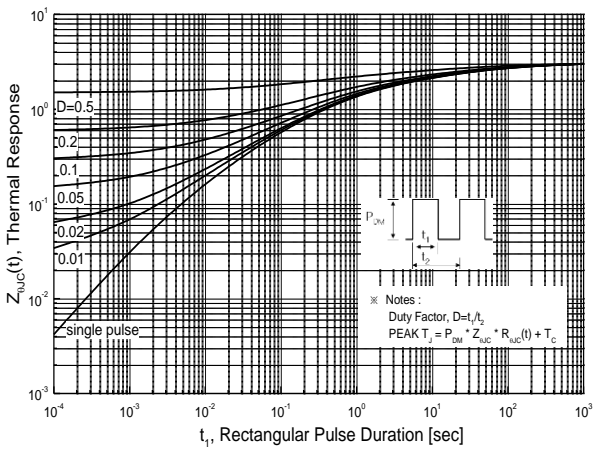

Fig.11 Transient Thermal Response Curve (Junction-to-Case)

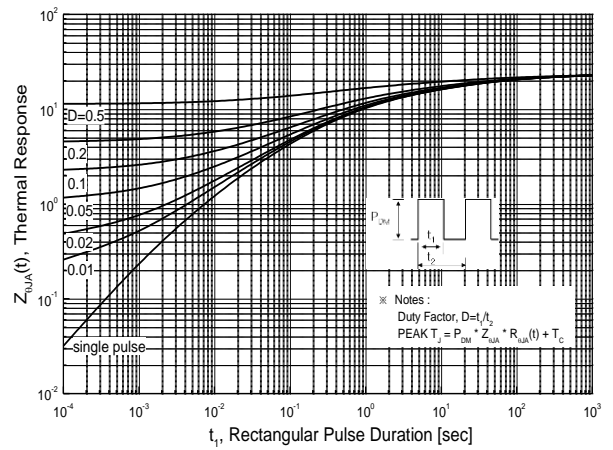
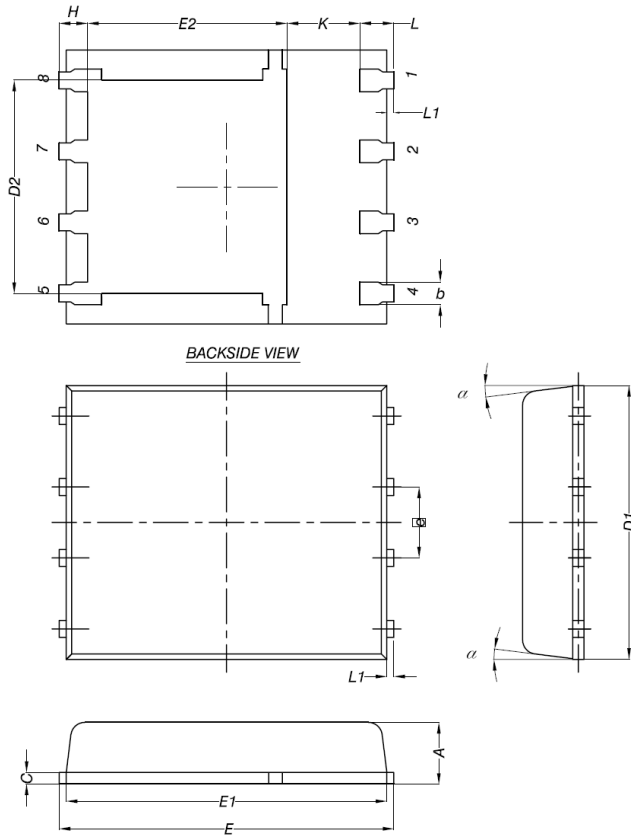

Fig.12 Transient Thermal Response Curve (Junction-to-Ambient)

Package Dimension

PowerDFN56 (5x6mm)

Dimensions are in millimeters, unless otherwise specified



Dimension	MILLIMETERS	
	Min	Max
A	0.90	1.10
b	0.33	0.51
C	0.20	0.34
D1	4.50	5.10
D2	-	4.22
E	5.90	6.30
E1	5.50	6.10
E2	-	4.30
e	1.27BSC	
H	0.41	0.71
K	0.20	-
L	0.51	0.71
α	0°	12°

Land Pattern

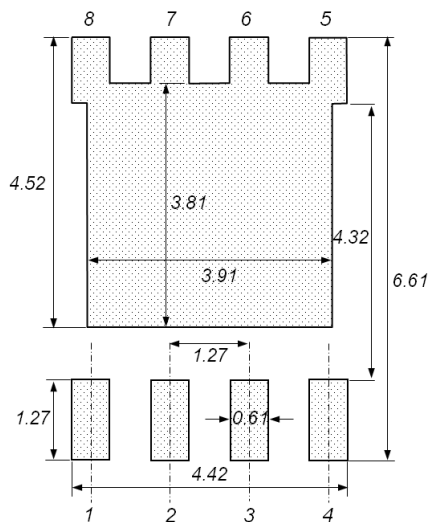

Note : Package body size, length and width do not include mold flash, protrusions and gate burrs.

DISCLAIMER:

The Products are not designed for use in hostile environments, including, without limitation, aircraft, nuclear power generation, medical appliances, and devices or systems in which malfunction of any Product can reasonably be expected to result in a personal injury. Seller's customers using or selling Seller's products for use in such applications do so at their own risk and agree to fully defend and indemnify Seller.

Magnachip reserves the right to change the specifications and circuitry without notice at any time. Magnachip does not consider responsibility for use of any circuitry other than circuitry entirely included in a Magnachip product.  Magnachip is a registered trademark of Magnachip Semiconductor Ltd.